



GENERAL CATALOG

AST • wwm



Corporate Headquarters

Eastern Region

37 Readington Road - Branchburg, NJ 08876 - Tel. 732.247.2300 - Fax 732.247.7258

Midwest Region

11853 Belden Court
Livonia, MI 48150
Tel: 734.206.4350
Fax: 734.293.4235

Gulf Region

2103 E. Governors Circle
Houston, TX 77092
Tel. 713.682.2400
Fax 713.682.2481

Western Region

16360 Downey Ave
Paramount, CA 90723
Tel. 562.633.4141
Fax 562.633.3280

Southeastern Region

3402 SW 26th Terrace Ste B-11
Ft. Lauderdale, FL 33312
Tel: 954.321.0784
Fax: 954.321.2591

www.worldwidemetric.com - sales@worldwidemetric.com



TURIN

Mole Antonelliana, built in 1863
A monument and symbol of the modern city of Turin (Julia Augusta Taurinorum), founded by the Romans in 28 BC.



RINA
www.rina.org

CERTIFICATO N. 90/94/S
CERTIFICATE No. 90/94/S

SI CERTIFICA CHE IL SISTEMA DI GESTIONE PER LA QUALITÀ DI IT IS HEREBY CERTIFIED THAT THE QUALITY MANAGEMENT SYSTEM OF

CAST S.P.A.

STRADA BRANZIZZO 40400 BIS 10088 VOLPIANO (TO) ITALIA
NELLE SEGUENTI UNITÀ OPERATIVE / IN THE FOLLOWING OPERATIONAL UNITS

STRADA BRANZIZZO 40400 BIS 10088 VOLPIANO (TO) ITALIA
VIA REG. GAMBIA, 365 10020 CASALGRASSO (CN) ITALIA

E CONFORME ALLA NORMA / IS IN COMPLIANCE WITH THE STANDARD
ISO 9001:2008

PER I SEGUENTI CAMPI DI ATTIVITÀ / FOR THE FOLLOWING FIELDS OF ACTIVITIES

PROGETTAZIONE E PRODUZIONE DI RACCORDI PER ALTA PRESSIONE IN ACCIAIO AL CARBONIO ED INOSSIDABILE AD USO INDUSTRIALE PER TUBAZIONI DA 4 A 640 mm DI DIAMETRO. ASSISTENZA TECNICA

DESIGN AND PRODUCTION OF HIGH PRESSURE FITTINGS IN CARBON AND STAINLESS STEEL FOR INDUSTRIAL APPLICATIONS FOR PIPING WITH 4 DIAMETER BETWEEN 4 AND 40 INCH. TECHNICAL ASSISTANCE

Il presente certificato è valido fino al 31 Agosto 2018

RINA Services S.p.A.
Via Cavour 12 - 10128 Cagliari (CA)

ACCREDIA

CISQ is a member of **INet**

MOLOGAZIONE DI TIPO
13813CS/001

con le prescrizioni delle norme qui specificate.

IN
DIN 2351

NO
DIZZO 404
NO (TO)

NO
DIZZO 404
NO (TO)
Sez. 10 delle Norme del RINA

Certificata e valida fino al 31 Agosto 2018

RINA
Francesco Scelzo

Il presente certificato è valido fino al 31 Agosto 2018

CISQ

Net

CERTIFICATION NETWORK

CIFICATE

and its partner
SORINA
that the organisation

CAST S.P.A.

OR BIS 10088 VOLPIANO (TO) ITALIA
operative units

OR BIS 10088 VOLPIANO (TO) ITALIA
2020 CASALGRASSO (CN) ITALIA
operative units

oper field of activities

CARBON AND STAINLESS STEEL FOR INDUSTRIAL APPLICATIONS FOR
IN 4 AND 42 mm. TECHNICAL ASSISTANCE

and maintaining a
Management System

in compliance of the following standard:
ISO 9001:2008

Registration Number: IT-2631
Current Issue: 2012-03-26

CISQ

Germanischer Lloyd
President of CISQ

Germanischer Lloyd

have been tested in accordance with
the System.

on steel CF59M/P336, 1150M/P37
cutting ring type B3

L-Series	6 - 18 [mm]	22 - 42 [bar]	
	315 [bar]	160 [bar]	
H-Series	6 - 14 [mm]	18 - 30 [bar]	38 [bar]
	620 [bar]	400 [bar]	315 [bar]

-20 [°C] up to 120 [°C]
6 - 42 [mm] for L-Series
6 - 28 [mm] for H-Series

all pipe unions of this type with cutting ring B3 are type
union couplings for the use in piping systems according to the
installations. Section 11, Table 11.13 11.14, compression
is resistant. For service temperatures above 40°C the
fit specified by the manufacturer is to be observed.

ments for Components and Systems of Mechanical Engineering
Edition 2008

ing to GL Approver Ref. No. 19-10895, 11-53529
and

pipe unions for the corresponding service and the right
in accordance with the instructions of the manufacturer.

Type Approval Symbol **GL**

Inspector Raschle Sven Dujdz

Inspector of Type Test, Part C Product

Internet Publication GL-Approved

DNV

DET NORSKE VERITAS

TYPE APPROVAL CERTIFICATE

CERTIFICATE NO. P-14374

This is to certify that the
Pipe Couplings, Flare and Compression Type

with type designation(s)
L-Series, S-Series

Manufactured by
CAST S.P.A.
Volpiano TO, Italy

is found to comply with
Det Norske Veritas' Rules for Classification of Ships
Det Norske Veritas' Standards for Certification 2.9 No. 5-792.20

Application:
The couplings may be used in the following: Hydraulic, Fuel, Lubrication Oil, Compressed Air, Steam and Condensate,
Freshwater, Seawater and Marsh Gas systems.

Type:	Temperature range:	Max. working press.:	Size:
L-Series	see cert.	315 bar - 160 bar (see cert.)	6 to 42 mm
S-Series	see cert.	630 - 315 bar (see cert.)	6 to 38 mm

This Certificate is valid until (2017-12-31)
issued in Havik, on (2013-02-21)

DNV local station: Milan
Approval Engineer: Mohsen Mohabbati

for Det Norske Veritas AS
Giorgio Sala
Acting Head of Section

Page 1 of 3

DNV

DET NORSKE VERITAS

APPROVAL CERTIFICATE

CERTIFICATE NO. P-14394

This is to certify that the
Couplings, Flared or Welded Nipple Type

with type designation(s)
SAE J 514 37" flared pipe fittings

Manufactured by
CAST S.P.A.
Volpiano TO, Italy

is found to comply with
"D05-D161, Marine and Machinery Systems and Equipment
Det Norske Veritas' Rules for Classification of Ships,
Det Norske Veritas' Standards for Certification 2.9 No. 5-792.20

Application:
The couplings may be used in the following: Hydraulic, Fuel, Lubrication Oil, Compressed Air, Steam and
Fresh and Sea water and Marsh gas systems.

Temp range: -40 °C to 200 °C (see cert.)
Press.: depending on size, see cert.
6 to 38 mm.

for Det Norske Veritas AS
Marianne Sparren Marvang
Head of Section

Page 1 of 3

DNV

DET NORSKE VERITAS

APPROVAL CERTIFICATE

CERTIFICATE NO. P-14493

This is to certify that the
Couplings, Flared or Welded Nipple Type

with type designation(s)
DNFS SAE J 1453 90° flared fittings

Manufactured by
CAST S.P.A.
Volpiano TO, Italy

is found to comply with
"Det Norske Veritas' Rules for Classification of Ships
Det Norske Veritas' Standards for Certification 2.9 No. 5-792.20

Application:
The couplings may be used in the following: Hydraulic, Fuel, Lubrication Oil, Compressed Air, Steam and
Fresh and Sea water and Marsh gas systems.

Temp range: -40 °C to +200 °C, see certificate
Press.: 630 bar, see certificate
6 to 38 mm

for Det Norske Veritas AS
Marianne Sparren Marvang
Head of Section

Page 1 of 3

DNV

DET NORSKE VERITAS

TYPE APPROVAL CERTIFICATE

CERTIFICATE NO. P-14412

This is to certify that the
Couplings of Non-Metallic Material with Permanently Fitted Couplings

with type designation(s)
EN837 15N, EN837 15C, EN837 25N and EN837 25C

Manufactured by
CAST S.P.A.
Volpiano TO, Italy

is found to comply with
"Det Norske Veritas' Rules for Classification of Ships
Det Norske Veritas' Offshore Standards
Det Norske Veritas' Standards for Certification 2.9 No. 5-791.70

Application:
The couplings may be used in the following: Hydraulic, Fuel, Lubrication Oil, Compressed Air, Steam and
Fresh and Sea water and Marsh gas systems.

Temp range: -40 °C to +100 °C
Max. working press.: 40 to 415 bar
Size: DMS to DN51 (3/16" to 2")

for Det Norske Veritas AS
Marianne Sparren Marvang
Head of Section

Page 1 of 3

FOR A CONSTANT IMPROVEMENT

The staff concerned full time in the Quality and Research is highly competent and constantly brought up to date and represents the 10% of the employees working with our company. Since 1993 our manual and quality procedures constantly follow the reference rules development. The numerous inspections carried out by the certification agencies have always confirmed the continuous adjustment to the ISO 9001 norm requirements and the steadfast improvement of our quality system.





NEW PRODUCTS – PROCESSES

Maximum safety is achieved by adopting international regulations for the production of standard fittings. We are obviously also committed to new products, new solutions and new applications to improve the existing technology with process and product innovations, as clearly shown below:

1. Increasing the working pressure of DIN 2353 carbon steel pipe fittings, pages 40 to 92: the identification of fittings having increased pressure rates will be allowed by means of the production year indicated in the traceability codes, starting from year 2013



2. New ecological zinc-plating process with increased resistance to corrosion, page 24;
3. New dust and processing residue anti-pollution process, page 24;
4. New “compact swivel elbow terminal”, pages 48 - 49;
5. New “compact male straight adapter” compliant with ISO 8434-6 Table 10 Fig. 9, page 163;
6. New series of fittings for flexible hoses “C4”, pages 293 to 333;
7. New series of fittings for high performance “Interlock” flexible hoses, pages 334 to 346;
8. New quick connection, page 347.

FOR A CONSTANT IMPROVEMENT

“PRODUCT RANGE”



DIN B3 - B4 - BP



JIC

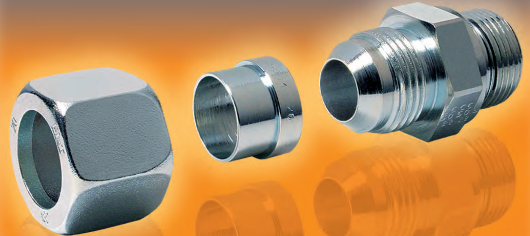

BS



ORFS



C4



VALVES



ETHICS → RESEARCH → QUALITY → SAFETY
DEVELOPMENT → RELIABILITY

APPLICATION FIELDS



VOLPIANO OFFICE BUILDING (TO)

Headquarters of CAST S.p.A.



















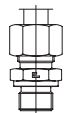
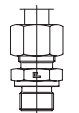
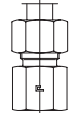







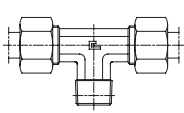

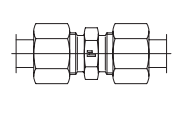



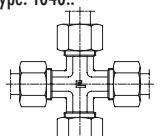
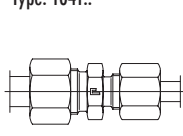



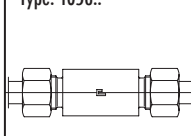

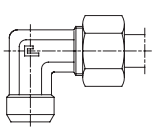
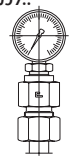
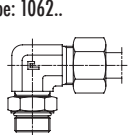
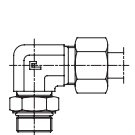



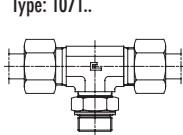

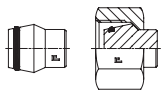



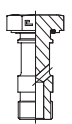

DIN 2353



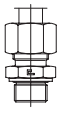





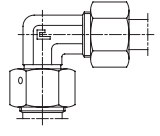

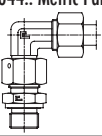
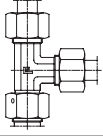
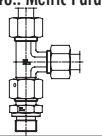
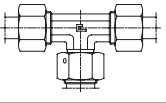
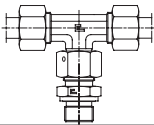
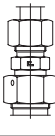

DIN

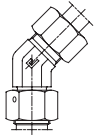
**CARBON STEEL AND STAINLESS STEEL
PRODUCT**

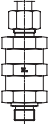
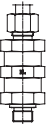
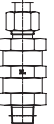

FIGURATIVE INDEX – FITTINGS DIN 2353 – ISO 8434-1

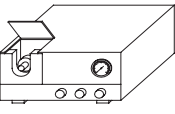
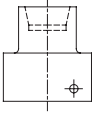
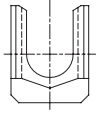
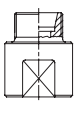
General instructions	Quality assurance	Allowed temperatures	Finish treatments	Tubes to be used	Threaded ends	Prescriptions to comply with
Utilisation standards	Safety factors	Seals on threads	End treatments	Tables follow up	Gas - Metric UNF - NPT	Assembly instructions
Page 21	Page 22	Page 23	Page 24	Page 25-26	Page 27-32	Page 33-39
Type: 1101..BP 	Type: 1001.. 	Type: 1001...4 	Type: 1002.. 	Type: 1003.. BSPP Type: 1004.. Metric Paral. 	Type: 1005.. BSPP Type: 1006.. Metric Paral. 	Type: 1007.. BSPP Type: 1008.. Metric Paral. 
Page 40	Page 41	Page 41	Page 41	Page 42-43	Page 44-45	Page 46
Type: 1009.. UNF/UN-2A 	Type: 1013.. BSPP Type: 1014.. Metric Paral. 	Type: 1015.. BSPP Type: 1016.. 	Type: 1017.. BSPT Type: 1018.. NPT 	Type: 1019.. Metric Taper 	Type: 1020.. BSPT 	Type: 1021.. NPT Type: 1022.. Metric Taper 
Page 47	Page 48-49	Page 50	Page 51-52	Page 52	Page 53	Page 54
Type: 1025.. BSPT Type: 1026.. NPT 	Type: 1030.. BSPT Type: 1031.. NPT 	Type: 1035.. 	Type: 1036.. 	Type: 1037.. 	Type: 1038.. 	Type: 1039.. 
Page 55	Page 56	Page 57	Page 57	Page 58	Page 58	Page 59
Type: 1040.. 	Type: 1041.. 	Type: 1045.. 	Type: 1049.. BSPP 	Type: 1055.. 	Type: 1056.. 	Type: 1057.. 
Page 59	Page 60	Page 61	Page 62	Page 62	Page 63	Page 63
Type: 1058.. 	Type: 1059.. 	Type: 1061.. BSPP Type: 1062.. 	Type: 1063.. UNF/UN-2A 	Type: 1064.. BSPP Type: 1065.. 	Type: 1066.. UNF/UN-2A 	Type: 1067.. BSPP Type: 1068.. 
Page 64	Page 64	Page 65	Page 66	Page 66-67	Page 67	Page 68
Type: 1069.. UNF/UN-2A 	Type: 1070.. BSPP Type: 1071.. 	Type: 1072.. UNF/UN-2A 	Type: 1073.. Type: 1073.. -D. 	Type: 1074.. BSPP 	Type: 1075.. BSPP 	Type: 1076.. BSPP Type: 1077.. 
Page 69	Page 70	Page 71	Page 71	Page 72	Page 72	Page 73
Type: 1078.. BSPP Type: 1079.. 	Type: 1080.. 	Type: 1081.. BSPP Type: 1082.. 	Type: 1084.. BSPP 	Type: 1085.. 	Type: 1086.. 	Type: 1087.. 
Page 73	Page 74	Page 74	Page 75	Page 75	Page 75	Page 75
Type: 1088.. BSPP Type: 1089.. 	Type: 6005.. BSPP Type: 6006.. 	Type: 6007.. BSPP Type: 6008.. 	Type: 6009.. UNF/UN-2A 	Type: 6010.. NPT 	Type: 6035.. 	Type: 6042.. 
Page 76	Page 77-78	Page 79	Page 80	Page 80	Page 81-82	Page 83

FIGURATIVE INDEX – FITTINGS DIN 2353 – ISO 8434-1

Type: 6043.. BSPP Type: 6044.. Metric Paral. 	Type: 6046.. 	Type: 6047.. BSPP Type: 6048.. Metric Paral. 	Type: 6050.. 	Type: 6051.. BSPP Type: 6052.. Metric Paral. 	Type: 6053.. 	Type: 6054.. 
Page 84	Page 85	Page 86	Page 87	Page 88	Page 89	Page 90
Type: 6055.. 	Type: 6060.. BSPP 	Type: 6061.. 	Type: 5001.. 	Type: 5002.. BSPP Type: 5003.. Metric Paral. 	Type: 5004.. BSPP Type: 5005.. Metric Paral. 	Type: 5006.. BSPT Type: 5007.. NPT 
Page 91	Page 91	Page 92	Page 92	Page 93	Page 94	Page 95
Type: 5008.. BSPT Type: 5009.. NPT 	Type: 100000 	Type: 1000.. 	Type: 1000.. 	Type: 1000.. 	Type: 1000.. 	Compatible fluids table
Page 96	Page 11	Page 11	Page 11	Page 11	Page 11	Page 352-356

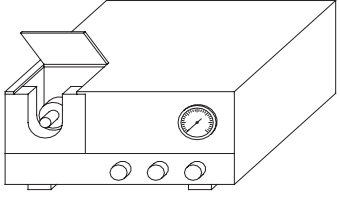
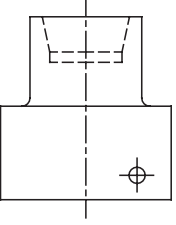
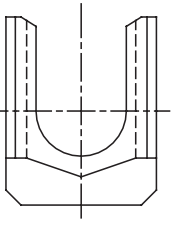
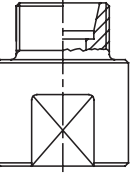
ASSEMBLY TOOLS DIN 2353 - ISO 8434-1

PREASSEMBLY MACHINE			MANDREL MACHINE	PLATFORM MACHINE	MANUAL PREASSEMBLY TOOL	24° TOOL
						
Series	Ø Tube	Ordering Machine	Ordering Mandrel	Ordering Platform	Ordering Preassembly	Ordering 24° tool
L	6	100000	100001	100021-83 M	100061	204
	8		100002	100022-83 M	100062	205
	10		100003	100023-83 M	100063	206
	12		100004	100024-83 M	100064	207
	15		100005	100025-83 M	100065	208
	18		100006	100026-83 M	100066	209
	22		100007	100027-83 M	100067	210
	28		100008	100028-83 M	100068	211
	35		100009	100029-83 M	100069	212
	42		100010	100030-83 M	100070	213
S	6	100000	100011	100031-83 M	100071	204
	8		100012	100032-83 M	100072	205
	10		100013	100033-83 M	100073	206
	12		100014	100034-83 M	100074	207
	14		100015	100035-83 M	100075	214
	16		100016	100036-83 M	100076	215
	20		100017	100037-83 M	100077	216
	25		100018	100038-83 M	100078	217
	30		100019	100039-83 M	100079	218
	38		100020	100040-83 M	100080	219

ORDERING EXAMPLES (Carbon steel)

ORDERING EXAMPLES (Stainless steel)

B3 STANDARD RING

- If you require a male stud coupling for a Ø 18 mm tube with 1/2" BSP parallel thread made of carbon steel with standard ring, order: 100309

B3 STANDARD RING

- If you require a male stud coupling for a Ø 18 mm tube with 1/2" BSP parallel thread made of stainless steel with standard ring, order: 110309

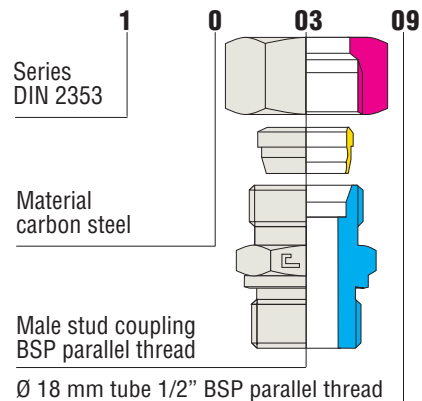

B4 PATENTED RING

- If you require a male stud coupling for a Ø 18 mm tube with 1/2" BSP parallel thread made of carbon steel with elastomeric NBR seal on the threaded end, specify: 100509.4
- If you require the VITON® seal, add "V" after the last fourth number 100509.4V

B4 PATENTED RING

- If you require a male stud coupling for a Ø 18 mm tube with 1/2" BSP parallel thread made of stainless steel with elastomeric Viton® seal on the threaded end, specify: 110309.4
- If you require the NBR seal, add "N" after the last fourth number 110309.4N

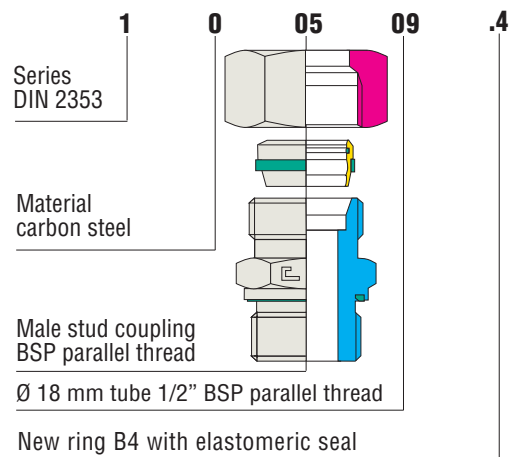

BODY FOR B3 – B4

- If you require the carbon steel body add 1 at the end of the fitting code to order: 100309.1

BODY FOR B3 – B4

- If you require the stainless steel body only, add 1 at the end of the fitting code to order: 110309.1

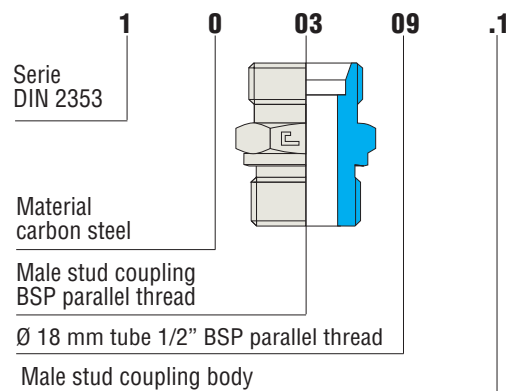

DELIVERIES

- Cast S.p.A. fittings are delivered in the configurations shown in the pictures of this catalogue.
- Available on scheduled orders only: it means that the article is slow moving and will be delivered within 90 days.
- Available on request only: it means that the article is not commonly in stock; please contact our offices for further delivery details.

VITON® is a DuPont Dow Elastomers Trade Mark



DIN 2353



B3

**CARBON STEEL AND STAINLESS STEEL PRODUCT
STANDARD DOUBLE CUTTING EDGE RING ASSEMBLED ON
ALL CAST PRODUCTION TO ASSURE SEALING AND SAFETY.
AVAILABLE IN CARBON AND STAINLESS STEEL**

THEORY OF OPERATION

The Cast fitting, manufactured according to ISO 8434-1/DIN 2353, is a mechanical fitting with a double cutting edge ring for double stapling on the tube.

The B3 ring helps fast assembly of removable tubes, avoids welding, tapping and flaring, thus assuring maximum simplicity for complex oleo-dynamic systems. During tightening by the nut, the ring deforms according to the bore of the 24° cone of the fitting and bites into the steel tube, producing two deep cuts, the first of which is visible due to the lifting of an outer edge on the diameter of the tube, ensuring water tightness and anti-unthreading of the ring. The second groove (invisible) balances the forces on the whole ring, prevents vibrations from reaching the first groove and stops the stapling of the tube at a predetermined value.

COUPLING SYSTEM DIN 2353

Traceability decoding:

CAST =
Logo of the
Manufacturer

- T =
Production plant
- 3 =
Year of manufacture
- CE =
Made in EEC
- 50 =
Type of steel used
- 01 =
Heat number of the
steel used

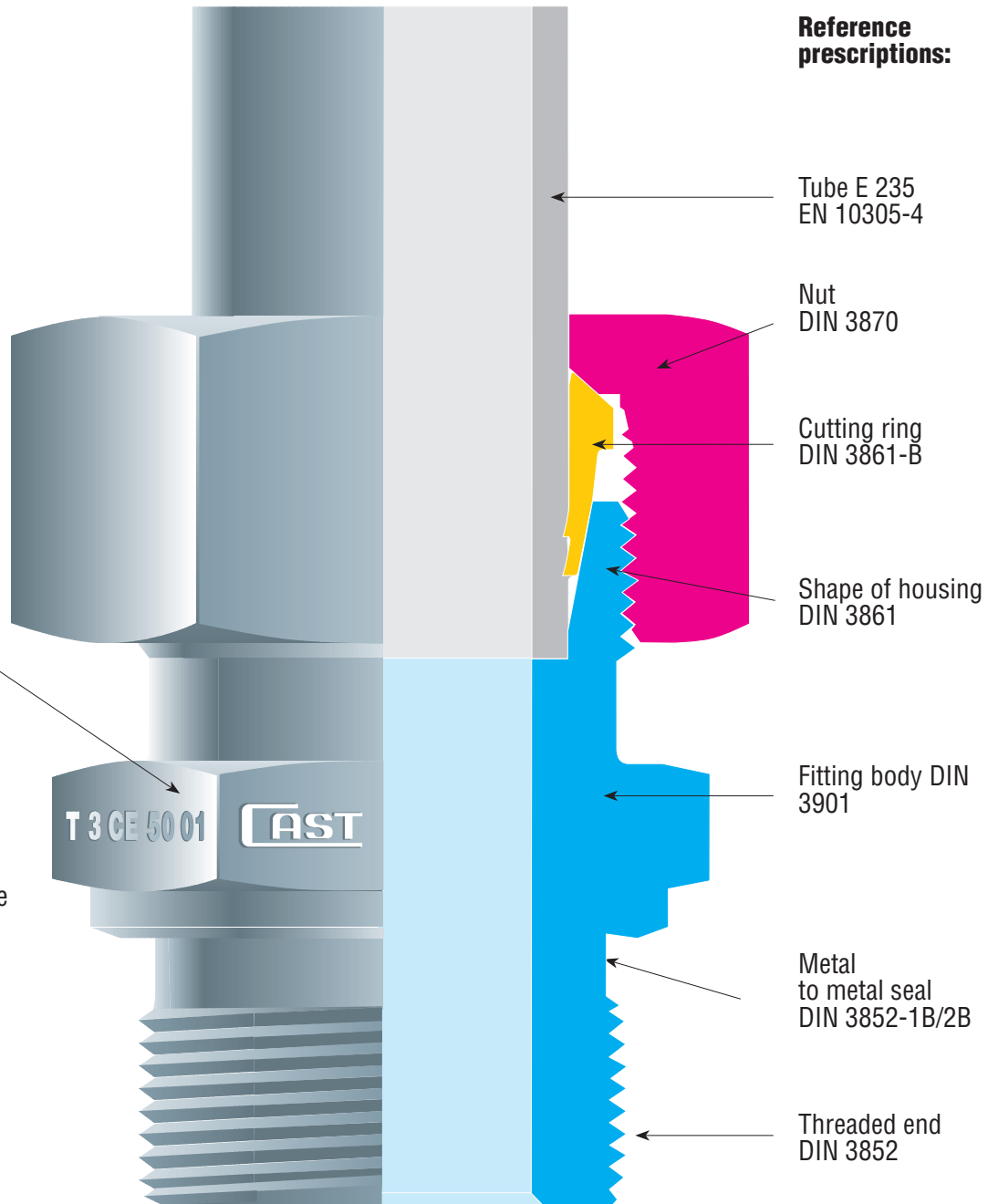

TECHNICAL CHARACTERISTICS

CAST fittings assure perfect seal regardless of the fluid used, provided that no corrosive fluids are employed and the nominal pressures be respected.

Fittings are manufactured in three ranges to be chosen according to the required working conditions.

The "LL" extra light range, suitable for low and medium working pressures up to 100 bars.

The "L" light duty series for applications characterised by medium high pressures of maximum 500 bars.

The "S" heavy duty series for harsh applications characterised by high temperatures and a maximum pressure of 800 bars.

Normal vibrations do not alter the fitting's performance, which, even at maximum values, retains its characteristics of absolute reliability.

Before assembly on the metal tube



After assembly on the metal tube

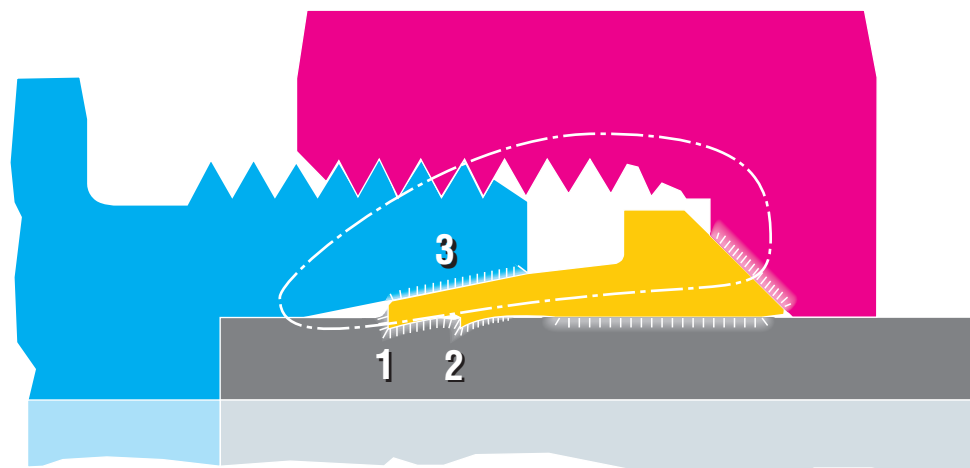

Field of force



Pressure surfaces



Sealing points

1 - 2 - 3



DIN 2353



**NEW SIX-SEALS CUTTING RING.
THE INTERNATIONAL INDUSTRIAL PATENT NR. 864061 OF 10/03/99
COMPLEMENTS AND DOES NOT REPLACE THE STANDARD RING CUR-
RENTLY IN USE.**

AVAILABLE IN CARBON AND STAINLESS STEEL

B4

THEORY OF OPERATION

The Cast fitting, manufactured according to ISO 8434-1/DIN 2353, is a mechanical fitting with a double cutting edge ring for double stapling on the tube.

“B4” is a highly innovative, deformable, double clinching, double edge ring with double elastomer seal.

It is assembled according to well-known techniques and is perfectly interchangeable with all types of rings used on 24° cone fittings complying with ISO 8434-1/DIN 2353 standards.

The ring helps fast assembly of removable tubes, avoids welding, tapping and flaring, thus assuring maximum simplicity for complex oleo-dynamic systems. During tightening by the nut, the ring deforms according to the bore of the 24° cone of the fitting and bites into the steel tube, producing two deep cuts, the first of which is visible due to the lifting of an outer edge on the diameter of the tube, ensuring water tightness and anti-unthreading of the ring. The second groove (invisible) balances the forces on the whole ring, prevents vibrations from reaching the first groove and stops the stapling of the tube at a predetermined value.

COUPLING SYSTEM DIN 2353

Reference prescriptions:

Tube E 235
EN 10305-4

Nut
DIN 3870

O-ring seal
CAST

Cutting ring
DIN 3861-B

Flat washer seal **CAST**

Shape of housing
DIN 3861

Fitting body
DIN 3901

Flat washer housing
DIN 3852-11E

Threaded end
DIN 3852

Traceability decoding:

CAST =
Logo of the
Manufacturer

- T =
Production plant
- 3 =
Year of manufacture
- CE =
Made in EEC
- 50 =
Type of steel used
- 01 =
Heat number of the
steel used

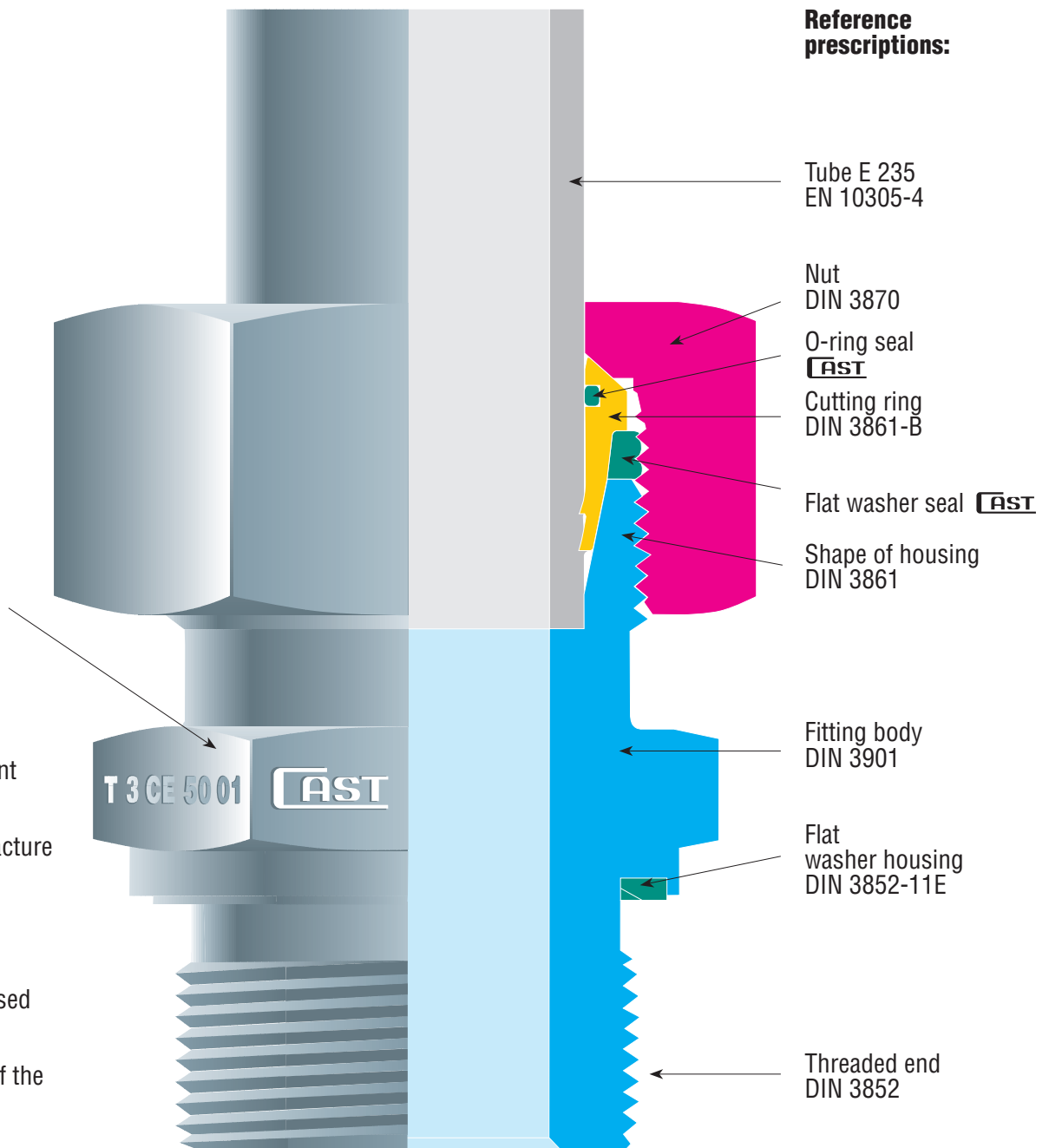

TECHNICAL CHARACTERISTICS

The “B4” ring assures perfect tightness of the circuit regardless of the fluid used, provided that corrosive fluids are avoided and the nominal pressures of the fittings are complied with. The fittings on which the “B4” rings are mounted are manufactured in two series, which are used according to the operating conditions.

The “L” light duty series for applications characterised by medium high pressures of maximum 500 bars.

The “S” heavy duty series for harsh applications characterised by high temperatures and a maximum pressure of 800 bars.

Normal vibrations do not alter the fitting’s performance, which, even at maximum values, retains its characteristics of absolute reliability.

When the fitting, ring, nut, tube system is assembled, the flat seal is compressed between the head of the cutting ring and the front of the fitting body. The mechanical pressure applied to the flat seal causes flexure towards the outside, with a consequent increase in diameter. The deformation causes the compressed material of the seal to fill the turns of the thread of the nut free from the closing coupling with the fitting body, assuring locking of the nut and preventing any vibration-induced loosening of this.

When the fitting is disassembled with the tool and nut, the flat seal goes back to its original shape, without any damage, freeing the nut threads used previously, also allowing for the manual unscrewing of the same nut.

Before assembly on the metal tube



After assembly on the metal tube

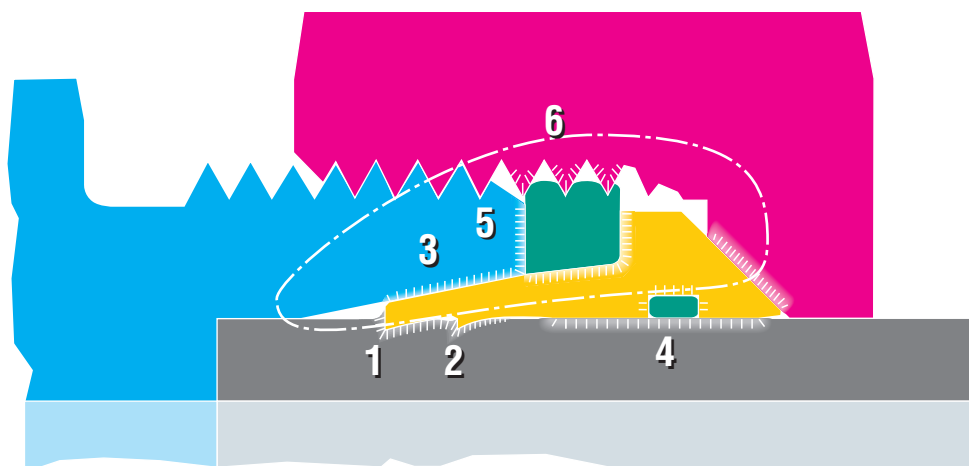

Field of force



Pressure surfaces



Sealing points

1 - 2 - 3 - 4 - 5 - 6

TECHNICAL INNOVATION

For many years now there has been an increasing imperative market demand for fluid system components that guarantee three main factors:

SAFETY, EASY ASSEMBLY, LEAKAGE-FREE TIGHTNESS.

These elements, now considered essential for a safe working environment (Law 626/94), product liability (Presidential Decree 224-EEC 85/374) and for the entire environmental protection system, have promoted the development of the new “B4” ring as an effective response to all the above-mentioned problems.

PRODUCT CONCEPT

The most original aspect of the product is that the structure of the existing ring has been used, inserting an O-Ring in the inside part to obtain another seal on the tube used; a flat seal has been used on the outer diameter to obtain two additional seals.

The main idea behind the development of the “B4” was to design a new cutting ring able to go one step beyond the known techniques and solve the problem of minor losses of tightness, leaks, sweating and loosening of the system fastening nut. With this new ring, the double clinching of the steel tube is still possible, as well as, for obvious reasons of safety, the visual inspection of the correct coupling between the ring and the steel tube, maintaining the perfectly functional current system of assembly that is widely known to product users.

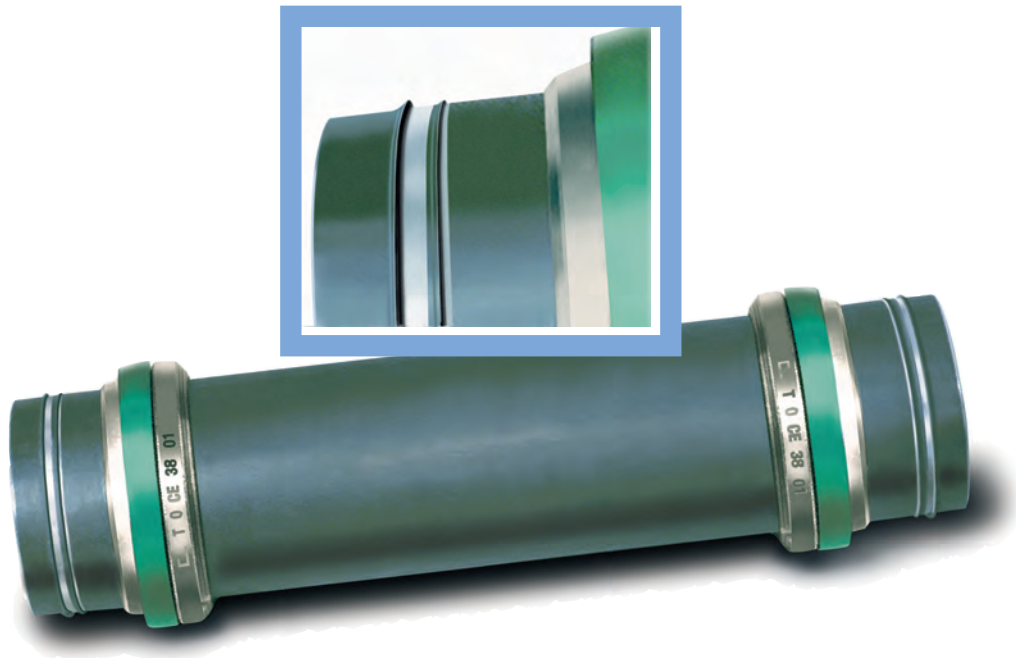

SEALING

B4” solves the problem of absolute tightness in the following way:

- On the outer diameter of the steel tube, with the double cutting edges and with an O-Ring placed inside the ring that provides a first seal with an elastomeric material that did not exist before.
- In the 24° cone of the fitting body, with an increase in the metal-on-metal contact area and with a flat seal placed statically on the outer diameter of the cutting ring which, when compressed between the head of the ring and the front of the fitting body, provides a second seal with an elastomeric material that did not exist before.
- In the thread of the system fastening nut, with the flat seal. When this is compressed between the head of the ring and the front of the fitting body, it fills the threads of the nut that are not engaged in clinching of the coupling system, thus providing a third seal with an elastomeric material that did not exist before.
- Basically, the “B4” provides six points of seal, of which three metal to metal and three by means of two soft elastomeric seals (the flat seal assures two sealing points), thus obtaining a product that ensures complete tightness without any leakage risk, even in particularly harsh operating conditions.

DEFINITION OF CONE SIZE TO DIN 3861 STANDARDS THREAD DIAMETERS TO DIN 3853 STANDARDS

Allowed for B3-B4-BP rings

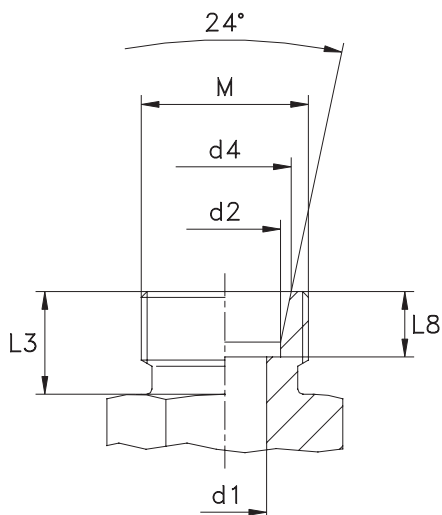

Series	Bar (DIN 2353)	ØTube	Metric Thread	d1	d2 ^{B11}	d4 ^{+0,1}	L3	L8 ^{+0,3}
LL	100	4	M8x1	3	4	5	8	4
		6	M10x1	4,5	6	7,5	8	5,5
		8	M12x1	6	8	9,5	9	5,5
L	250	6	M12x1,5	4	6	8,1	10	7
		8	M14x1,5	6	8	10,1	10	7
		10	M16x1,5	8	10	12,3	11	7
		12	M18x1,5	10	12	14,3	11	7
		15	M22x1,5	12	15	17,3	12	7
	160	18	M26x1,5	15	18	20,3	12	7,5
		22	M30x2	19	22	24,3	14	7,5
	100	28	M36x2	24	28	30,3	14	7,5
		35	M45x2	30	35	38	16	10,5
42		M52x2	36	42	45	16	11	
S	630	6	M14x1,5	4	6	8,1	12	7
		8	M16x1,5	5	8	10,1	12	7
		10	M18x1,5	7	10	12,3	12	7,5
		12	M20x1,5	8	12	14,3	12	7,5
		14	M22x1,5	10	14	16,3	14	8
	400	16	M24x1,5	12	16	18,3	14	8,5
		20	M30x2	16	20	22,9	16	10,5
		25	M36x2	20	25	27,9	18	12
	250	30	M42x2	25	30	33	20	13,5
		38	M52x2	32	38	41	22	16

GENERAL INSTRUCTIONS FOR B3 - B4 - BP RINGS

- Before starting the preassembly make sure that the pierce of the machine and the hardened blocks are in perfect working order. Further inspections are necessary during the preassembly (every 30-50 tightenings). For this purpose we recommend you to use a control buffer 1000... pierce and replace any block out of tolerance.
- Over the whole tightening phase the tube must be in touch with the inner part of the body of the fitting. If this does not happen, the ring will advance with the tube without indenting it, making the coupling not functional and requiring the operation to be carried out again. The tube must not turn with the nut during the tightening phase; the capability of the ring to rotate, once the pre-assembly is done, is not a deficiency but rather a consequence of the right elasticity of the ring. Always check that the tube is correctly indented. If the indentation does not cover 80% of the cutting ring front side then the assembly is not functional and must be done again. Indicated pressures in the catalogue are for steel tubes only.
- In case thin wall tubes are used, specially mild tubes, or tubes in RILSAN or similar, the assembling is possible, but a suitable reinforcement must be inserted into the end of the tube that is going to be tightened. Without the reinforcement it is not possible to operate with the materials mentioned above. In this case, carefully assess the working pressure.
- Before assembling the preassembled tube to the equipment it is necessary to check that the tube and the fitting are aligned. Fittings should never be used to correct a wrong alignment or to be a support for the tube. Extremely long tubes or tubes under-going high stress must be fixed by using some support to avoid excessive vibrations. A poor alignment could damage the operation of the system.
- The proper lubrication of the components involved in the tightening is essential for good system operation. We advise the use of mineral oils or torquen tension for carbon steel fittings, consisting of anti-seizing compound (Nickel based), Chesterton or similar, for stainless steel fittings.
- The fittings and the valves in this technical catalogue may be used for fluid-dynamic connections only. Indicated pressures in the catalogue are for steel tubes only.
- Mixing carbon and stainless steel components is not allowed.

UTILISATION STANDARDS FOR B3 - B4 - BP

CARBON STEEL FITTINGS

- High quality tubes must be employed to assure correct use and related technical performance of the carbon steel fitting. The use of tubes without the aforementioned characteristics may seriously impair the efficiency of the fitting. We recommend using the following tubes only: calibrated, seamless, cold drawn and threaded tubes. Normalised with inert gas, made of material E235 according to EN 10305-4 (ST 37.4 according to DIN 1630 I DIN 2391). The maximum hardness allowed on the outside diameter of the tube is 75 HRB.
- All carbon steel tubes with a diameter of more than 10 mm must be pre-assembled using the specific preassembly machine. If this is not available, hardened blocks, to be clamped in vice for manual preassembly, must be used. Remember to oil the thread, nut and ring. If hardened pre-assembly blocks are not available, normal straight fittings can be used. The fitting used once must be replaced at each tightening. During preassembly, pay special attention to parts such as reducing standpipes and nipples as these are made of raw materials characterised by higher resistance compared with the cuts made on annealed tubes. These parts must always be pre-assembled on hardened or 24° cones (for all diameters).

STAINLESS STEEL FITTINGS

- High quality tubes must be employed to assure correct use and related technical performance of stainless steel fittings. The use of tubes without the aforementioned characteristics may seriously impair the efficiency of the fitting. We recommend using the following tubes only: calibrated and polished, cold drawn seamless tubes 1.4571 as per UNI EN 10216-5 or ASTM A 269; the maximum permitted hardness, measured on the outer diameter of the tube, is 85 HRB. Electrically welded tubes may be used, provided that these comply with the mechanical tolerances of the aforementioned standards and related hardness values for fittings compliant with SAE J514, BS 5200, SAE J1453.
- All stainless steel tubes must be pre-assembled using the specific preassembly machine. If this is not available, hardened blocks must be used for manual preassembly. In this case, make sure that the bench and vice in which the block is clamped are firmly fastened to prevent any possibility of movement caused by the twisting moment applied to the nut during the preassembly phase. Assembly or preassembly operations directly on the stainless steel fitting are not allowed.

QUALITY ASSURANCE ACCORDING TO UNI EN ISO 9001:2008

The Quality Assurance System complies with UNI EN ISO 9001:2008, certificate (N.90/94/S) issued by the RINA certification authority recognised by IQNET at European level.

CAST S.p.A. has obtained the product homologation with the following registers:

- Germanischer Lloyd for carbon steel fittings with "B3" standard ring;
- RINA for carbon steel and stainless steel fittings with "B3" standard ring and "B4" patented ring;
- DNV for carbon steel and stainless steel fittings with "B3" standard ring and "B4" patented ring, JIC 37° complying with SAE J514, ORFS complying with SAE J1453 and for fittings for braided flexible tubes of the 80 series. CAST S.p.A. fully complies with the reference standards.

At the customer's request, our Quality Service will issue certificates of origin for the materials used to manufacture the products delivered. E.g.: Document 3.1.

Our Quality Experts are always ready to provide customers with advice, guide them around our facilities and inform them about the traceability system applied on our entire production range.

METROLOGY-TESTING LAB

A metrology lab equipped with state-of-the-art metallography microscopes, profile projectors, durometers, profilometers, micro-durometers, micro-meters, surface plates, comparators, buffers for various series of threads, etc., and a testing lab, equipped with three benches for static and dynamic tests, up to a pressure of 4000 bars, ensure the right tools for research, development, quality and safety control of our production.

Highly trained specialised staff ensure that the technology is always up-to-date and that the knowledge and means are used in the best way possible, in compliance with the company's ethics.

COMPONENT TESTING ON THE ENTIRE PRODUCT RANGE

In addition to the normal dimensional checks carried out during machining, percentage inspections of the finished product, practical tightness and fatigue tests, CAST fittings undergo coupling tests between the various parts. This check is carried out on the entire production. At the customer's request, our Product Test and Inspection Service issues a certificate of the tests carried out: checking of static seal at low and high pressure, dynamic seal at high pressure (maximum working pressure + 33%) as per ISO 19879 and ISO 6803. If required by the customer, tests can be carried out by various Third Party Authorities including: RINA-DVGW-Lloyd's Register of Shipping-Det Norske Veritas-Germanischer Lloyd-American Bureau of Shipping (to be specified on the order).

SAFETY FACTORS

"B3", "B4" and "BP" rings provide the right answer to safety problems so that absolute functional reliability between the ring, the steel tube and the fitting body is guaranteed by the double clinching and automatic locking of the cuts on the steel tube (assured by the particular shape of the ring). If on one side we increase the safe fastening, on the other we set a precise mechanical limit at the cutting of the tube, with the certainty of correct function.

- The nominal working pressures (bar) given in the catalogue indicate the maximum permissible pressures (including pressure peaks). For higher pressure the items must be tested in accordance with the manufacturer for specific applications.
- The safety factor is 4:1 and is intended with static load and with the temperature at the values indicated in the CAST S.p.A. Catalogue (series DI N, JIC, BS and ORFS) for tube connection. The same safety factor 4:1 is intended for parallel threaded end fittings with elastomeric seal.
- For stud couplings with taper or parallel threaded end fittings with metal to metal seal, the safety factor is 2.5:1.
- It is understood that the product is guaranteed only if the full connection is made entirely with our products and components.



*Destructive testing with 28x3 carbon steel tube.
The tube burst at 1050 bars without any leakage or sweating from the sealing points.*

GENERAL INFORMATION

• STEEL USED ON ALL SERIES

With a view to R&D and continuous improvement, our company has examined the issues of best usage of the raw material for the creation of our product. The steels used are all of the finest quality and are exclusively purchased from leading European steel works. All the batches used have testing documentation 3.1 reporting the number of heat as well as the chemical characteristics and mechanical characteristics. The above applies to carbon steel and stainless steel. The reference standards for the raw material normally used before are in line with the following principles: UNI EN 10087, UNI EN 10083-2, UNI EN 10025, UNI EN 10088-3 and so on.

• ALLOWED STEEL TEMPERATURES

Carbon Steel -40°C to + 120°C, according to ISO 8434
Stainless steel -60°C to + 200°C, according to ISO 8434

• PRESSURE REDUCTIONS

The allowed working pressure for stainless steel fittings manufactured with 1.4571 must be reduced according to the working temperature registered as per ISO 8434.
In case of multi-components systems all the parameters must be calculated on the weakest component used.

Type of steel	Working temperature	Lowering percentage
1.4571	≥ 50°C	- 4%
1.4571	≥ 100°C	- 11%
1.4571	≥ 200°C	- 20%

• GASKETS AND O-RINGS

The gaskets and o-rings used on valves and fittings are normally manufactured in NBR and have a working temperature of -35°C and +100°C. For higher temperatures VITON® gaskets and o-rings are suggested with working temperatures between -25°C and +200°C.

The gaskets made of NBR used in the valves and for the end seals have a hardness of 85±5 shores, while those in VITON® have a hardness of 80±5 shores.

The o-rings made of NBR and VITON® have a hardness of 80±5 shores, except for those used on the tube side seal of the ORFS fittings, which have a hardness of 90±5 shores.

The gaskets and o-rings, just like the products they are assembled on, must be managed according to DIN 7716 (requisites for the stocking of rubber and India rubber products).

• SEALS ON THREADED ENDS

To obtain the maximum performance, the taper male thread is to be matched with the taper female thread. The cylindrical male thread is to be matched with the cylindrical female thread. It is possible to match a taper male thread with a cylindrical female thread, but this combination is technically valid only in pipings where medium/low performance is required, and is never to be used where high pressures are applied. In case of matching of a cylindrical thread with relatively soft material, it is advisable to use the plain gasket type of seal that guarantees a perfect seal even with a relatively low tightening torque.

• CARBON STEEL FITTINGS FINISH TREATMENT

All Cast S.p.A. fittings, valves and components undergo surface treatment protection of the type: Zinc plating Fe/Zn 7 IV-Fe/Zn8 b/c 1 B UNI ISO 2081-4520, plus FINIGARD 460 top coat, equivalent to a Cathodic electrolytic zinc-plating with trivalent chromium. The fitting acts as a cathode (negative), the zinc which is deposited acts as an anode (positive), the deposited thickness is around 8+12 µm.

To be able to reach the resistance of 400 hours ±15% to white salt and 750 hours ±15% to red salt, a top coat is applied which, in addition to guaranteeing the required performance, facilitates assembly.

The top coat has the task of filling all the micro cavities in the zinc-plating treatment, which represent an initial part of the corrosion outbreaks. By sealing these micro defects, the zinc-plating treatment significantly improves its protective performance to the values indicated previously. The resistance to corrosion of this new type of zinc-plating notably increases compared to the previous one. The appearance has a silver colour with yellow shades.

It complies with current European environmental laws on hazardous waste and with the European EVL standard as it uses trivalent chromium (CrIII), in compliance with local laws protecting the health of people and the precautionary principle of protecting our environment.

The zinc-plating will be identified by reading the traceability codes of the year of production, starting from 2013. The new zinc-plating applies from this date onwards.

• STAINLESS STEEL FITTINGS FINISH TREATMENT

All the fittings and valves are treated with a chemical cleaning process that eliminates all oxides and burrs due to the machining phase, without altering or damaging the product. After this, a bath cleans the product and takes away any residual impurities. The piece at the end of the treatment looks really bright, perfect for oleo-dynamic industrial applications.

• THERMAL TREATMENTS FOR STAINLESS STEEL RINGS

After being machined, the rings are heat treated to harden the surface. This type of treatment, on stainless steel cutting rings, may decrease the amagnetivity of the ring itself. A slight amagnetivity is therefore inevitable and does not indicate a defect.

• ANTI-POLLUTION TREATMENT

• CAST S.p.A, with a view to “Continuous Improvement”, has implemented an operating system to avoid contamination from dust or working residues occurring inside its production facilities, which may in some way jeopardise the function of the component and damage the actuators (valves, cylinder, etc) from the entire circuit.

• In short, all of CAST S.p.A.’s fittings, after various checks and treatments during the entire production cycle, undergo a last process/check to cancel the micro bubbles on the threads, insert any o-Rings or gaskets, clean dust, burrs or processing dross and cap the component to maintain the result obtained with these operations until the use.

• The reference standards that CAST S.p.A. uses to check the level of cleanliness of its pipe fittings are the following: ISO 16232-3 and ISO 16323-1 O.

• For flexible hoses and rigid steel tubes, flushing is advised before installation or system execution.

• LUBRICATION OF THE STAINLESS STEEL THREADS

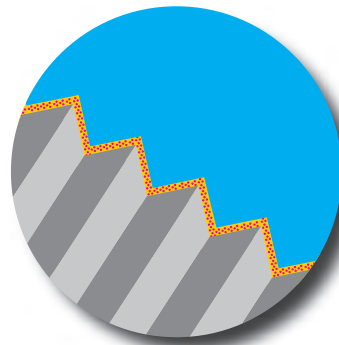
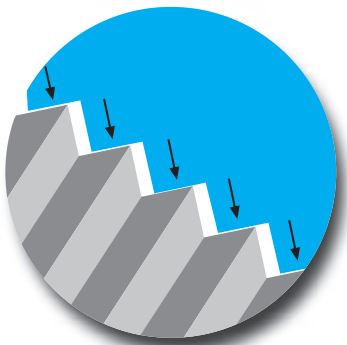

STAINLESS STEEL FITTINGS

- The special characteristics of this type of steel (hard but mild) require special attention to be paid to avoid problems.
- One of these requirements is the correct lubrication of all the components to be done during pre-assembling and assembling.
- Therefore, always use the right lubricant to create functional and safe systems to be able to assemble and dismantle the system without effort, seizures and at an affordable price.

ANTI-SEIZING COMPOUND (NICKEL BASIS)

- The anti-seizing compound (Nickel Basis) exposed to a strong pressure originates “millions of grains of Nickel” rolling between the surfaces.
- It allows a safer tightening and an easier unblocking. This compound may be used both indoors and outdoors.
- It protects the threads from wearing out and breaking, keeps away rust and corrosion.
- Nickel covers the connected surfaces avoiding any founding or welding and moreover there is only pure colloidal nickel and no trace of carbonic deposits.
- Compliant with specification Mi I. 907 D.
- Approved by the Ministry of Agriculture of the United States of America (USAD).
- Packaging weight 227 gr. Art. 82356. N.B.:
- Do not use on systems with oxygen or in the presence of ammonia or acetylene.

• CARBON STEEL TUBES ALLOWED ON ALL SERIES

- For carbon steel tubes we advise using calibrated seamless cold drawn tubes, normalised with inert gas, in E235 material according to EN 10305-4 (ST 37.4 according to DIN 1630 I DIN 2391).
- Maximum allowed hardness on the outside diameter of the tube is 75HRB.
- The pressures stated in the table below are generally intended at a constant rate and with temperatures ranging between -40°C and + 120°C.

ØTube mm	Tolerance EN 10305-4 mm	Thickness mm	Static DIN 2413-I pressure bar	Dynamic DIN 2413-III pressure bar	Weight Kg/m
4	±0,1	0,5	313	274	0,047
4		1	522	502	0,075
6	±0,1	1	389	374	0,123
6		1,5	549	528	0,166
6		2	692	665	0,197
8	±0,1	1	333	289	0,222
8		1,5	431	441	0,240
8		2	549	528	0,296
8		2,5	658	632	0,339
10	±0,1	1	282	249	0,222
10		1,5	373	358	0,314
10		2	478	460	0,395
10		2,5	576	553	0,462
10		3	666	641	0,518
12	±0,08	1 ⁽¹⁾	235	210	0,271
12		1,5	353	305	0,388
12		2	409	393	0,493
12		2,5	495	476	0,586
12		3	576	553	0,666
12		3,5	651	627	0,734
14	±0,08	1,5	302	265	0,462
14		2	403	343	0,592
14		2,5	434	417	0,709
14		3	507	487	0,814
14		3,5	576	553	0,906
15	±0,08	1,5	282	249	0,499
15		2	376	323	0,641
15		2,5 ⁽³⁾	409	393	0,771
15		3	478	460	0,888
16	±0,08	1 ⁽³⁾	176	161	0,370
16		1,5 ⁽²⁻³⁾	264	234	0,536
16		2	353	305	0,691
16		2,5	386	372	0,832
16		3	452	435	0,962
18	±0,08	1 ⁽³⁾	157	143	0,419
18		1,5 ⁽¹⁾	235	210	0,610
18		2	313	274	0,789
18		2,5	392	335	0,956
18		3	409	393	1,111
18		4 ⁽³⁾	522	502	1,381

ØTube mm	Tolerance EN 10305-4 mm	Thickness mm	Static DIN 2413-I pressure bar	Dynamic DIN 2413-III pressure bar	Weight Kg/m
20	±0,08	2 ⁽²⁻³⁾	282	249	0,888
20		2,5	353	305	1,079
20		3	373	358	1,258
20		3,5	426	410	1,424
20		4	478	460	1,578
22	±0,08	1,5 ⁽³⁾	192	174	0,758
22		2 ⁽¹⁾	256	228	0,986
22		2,5	320	280	1,202
22		3	385	329	1,406
22		4 ⁽³⁾	441	424	1,766
22		5 ⁽³⁾	532	512	2,367
25	±0,08	2 ⁽¹⁾	226	202	1,134
25		2,5	282	249	1,387
25		3	338	294	1,628
25		4	394	379	2,072
25		4,5	437	420	2,275
25		5 ⁽³⁾	478	460	2,466
28	±0,08	2 ⁽¹⁾	201	182	1,282
28		2,5	252	224	1,572
28		3	302	265	1,850
28		4 ⁽³⁾	403	343	2,368
28		5 ⁽³⁾	434	417	2,836
30	±0,08	2 ⁽²⁻³⁾	168	171	1,381
30		2,5	235	210	1,695
30		3	282	249	1,998
30		4	376	323	2,565
30		5 ⁽³⁾	409	393	3,083
32	±0,15	3 ⁽³⁾	265	235	2,146
32		4 ⁽³⁾	353	305	2,762
32		5 ⁽³⁾	387	372	3,329
35	±0,15	2 ⁽¹⁾	161	147	2,189
35		2,5	201	182	2,004
35		3	242	216	2,367
35		4	322	281	3,058
38	±0,15	3 ⁽²⁻³⁾	223	200	2,589
38		4	297	261	3,354
38		5	371	319	4,069
42	±0,2 ⁽⁴⁾	3	201	182	2,885
42		4	269	238	3,749

(1) Tubes that require a support sleeve if used for DIN 2353 applications only

(2) Tubes to be used for 37° fittings compliant with ISO 8434-2/SAE J514

(3) Tubes to be used for ORFS fittings compliant with ISO 8434-3/SAE J1453

(4) Due to a technical choice, CAST S.p.A. builds the 042 tube housing with a tolerance of 811.

CALCULATION PRESSURES

The calculation of the pressure with static load is made to DIN 2413-1 with yield point K= 235N/mm².

For tubes with an external/internal diameter ratio >1.35, calculation is made to DIN 2413-III but with yield point K= 235N/mm².

The calculation of the pressure with dynamic stress is made to DIN 2413-III with permanent fatigue strength K= 226N/mm².

Safety factor S= 1.5

Allowance factor c= 0.8 for 4mm Ø tube, c= 0.85 for 6-8mm Ø tube, c= 0.9 for >8mm Ø tube

Corrosion: no additional allowance is considered for pressure calculations.

• STAINLESS STEEL TUBES ALLOWED ON ALL SERIES

- For stainless steel tubes we advise using calibrated and polished, seamless, cold drawn tubes in material 1.4571 as per UNI EN 10216-5 or ASTM
- Maximum allowed duration on the outside diameter of the tube is 85 HRB.
- The pressures stated in the table below are generally intended at a constant rate and with temperatures ranging between -60°C and + 200°C.

ØTube mm	Tolerance EN 10305-4 mm	Thickness mm	Static DIN 2413-I pressure bar	Weight Kg/m
4	±0,1	0,5	326	0,048
4		1	544	0,076
6	±0,1	1	406	0,125
6		1,5	572	0,169
6		2	721	0,200
8	±0,1	1	347	0,225
8		1,5	449	0,244
8		2	572	0,301
8		2,5	686	0,344
10	±0,1	1	294	0,225
10		1,5	389	0,319
10		2	498	0,401
10		2,5	601	0,469
10	±0,08	3	694	0,526
12		1 ⁽¹⁾	245	0,275
12		1,5	368	0,394
12		2	426	0,500
12	±0,08	2,5	516	0,595
12		3	601	0,676
12		3,5	679	0,745
14	±0,08	1,5	315	0,469
14		2	420	0,601
14		2,5	452	0,720
14		3	529	0,826
14	±0,08	3,5	601	0,920
15		1,5	294	0,507
15		2	392	0,651
15	±0,08	2,5 ⁽³⁾	426	0,782
15		3	498	0,902
16	±0,08	1 ⁽³⁾	183	0,373
16		1,5 ⁽²⁻³⁾	275	0,544
16		2	368	0,702
16		2,5	402	0,845
16		3	471	0,977
18	±0,08	1 ⁽³⁾	163	0,423
18		1,5 ⁽¹⁾	245	0,619
18		2	326	0,801
18		2,5	409	0,971
18		3	426	1,128
18		4 ⁽³⁾	544	1,401

ØTube mm	Tolerance EN 10305-4 mm	Thickness mm	Static DIN 2413-I pressure bar	Weight Kg/m
20	±0,08	2 ⁽²⁻³⁾	294	0,902
20		2,5	368	1,095
20		3	389	1,277
20		3,5	444	1,446
20		4	498	1,602
22	±0,08	1,5 ⁽³⁾	200	0,764
22		2 ⁽¹⁾	267	1,001
22		2,5	334	1,220
22		3	401	1,427
22		4 ⁽³⁾	459	1,802
22	±0,08	5 ⁽³⁾	555	2,402
25		2 ⁽¹⁾	236	1,151
25		2,5	294	1,408
25		3	352	1,653
25		4	411	2,104
25	±0,08	4,5	456	2,310
25		5 ⁽³⁾	498	2,490
28		2 ⁽¹⁾	210	1,301
28		2,5	263	1,596
28		3	315	1,878
28	±0,08	4 ⁽³⁾	420	2,403
28		5 ⁽³⁾	452	2,878
30		2 ⁽²⁻³⁾	175	1,402
30	±0,08	2,5	245	1,721
30		3	294	2,028
30		4	392	2,604
30		5 ⁽³⁾	426	3,110
32	±0,15	3 ⁽³⁾	275	2,177
32		4 ⁽³⁾	368	2,803
32		5 ⁽³⁾	403	3,378
35	±0,15	2 ⁽¹⁾	168	2,222
35		2,5	210	2,034
35		3	252	2,403
35		4	336	3,104
38	±0,15	3 ⁽²⁻³⁾	232	2,628
38		4	310	3,405
38		5	387	4,131
42	±0,2 ⁽⁴⁾	3	210	2,929
42		4	280	3,806

- (1) Tubes that require a support sleeve if used for DIN 2353 applications only
(2) Tubes to be used for 37° fittings compliant with ISO 8434-2/SAE J514
(3) Tubes to be used for ORFS fittings compliant with ISO 8434-3/SAE J453
(4) Due to a technical choice, CAST S.p.A. builds the 042 tube housing with a tolerance of 811.

CALCULATION PRESSURES

The calculation of the pressure with static load is made to DIN 2413-1 with yield point K= 245N/mm².

For tubes with an external/internal diameter ratio >1.35 calculation is made to DIN 2413-111 but with yield point K= 245N/mm².

Pressures with dynamic stress according to DIN 2413-111 are not listed because in EN 10216-5 the permanent fatigue stress K is also not listed. We recommend, for calculation in accordance to DIN 2413-111, to assume a value K= 190N/mm².

Safety factor S= 1.5

Allowance factor c= 0.9

Corrosion: no additional allowance is considered for pressure calculations.

- The insufficient thickness of the tube walls, or the too low longitudinal resistance of the tubes (particularly mild soft steel) may result in problems with the cutting, with relevant loss of seal and a drastic decrease in the safety factor. This aspect must be considered when choosing the tube. It is a good rule to pick tubes that make it so that the internal flare (decreasing of the internal diameter) does not exceed 3/10 of a millimetre up to an outer diameter of 16mm and 4/10 of a millimetre for greater diameters.

STUD ENDS WITH BSPP THREAD

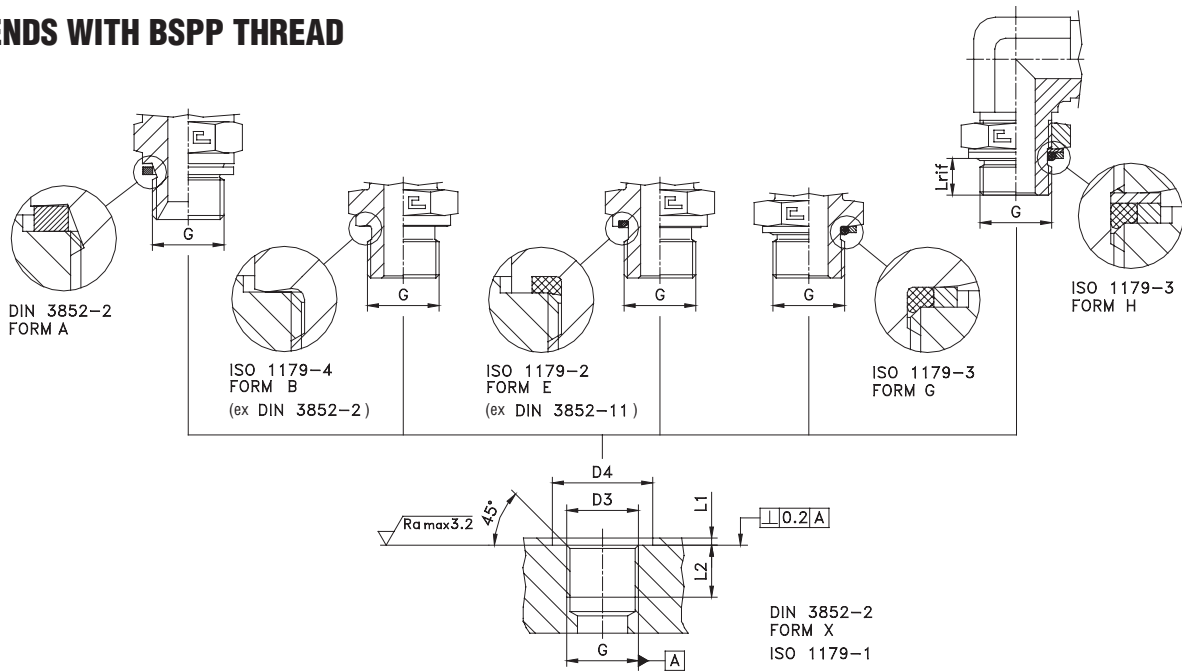

Series	Ø Tube	Thread Gas	D3	D4 min			L1 max	L2 min	L ref	Torque [Nm] ^{+10%}						
				form A/B/E	form G/H	form A				form B	form E	form E (caps 1076..)	form G	form G (caps 1078..)	form H	
DIN	L	6	G 1/8	9,8	15	17,2	1	8	7,5	-	20	20	10	20	10	20
		8-10	G 1/4	13,2	20	20,7	1,5	12	10,2	-	45	45	25	45	25	45
		12	G 3/8	16,7	23	24,5	2	12	10,4	-	70	70	40	70	40	70
		15-18	G 1/2	21	28	29,6	2,5	14	13,1	-	130	85	75	85	75	85
		22	G 3/4	26,5	33	36,9	2,5	16	13,5	-	170	170	120	170	120	170
		28	G 1	33,3	41	46,1	2,5	18	14,7	-	330	330	230	330	230	330
		35	G 1 1/4	42	51	54	2,5	20	14,7	-	510	430	300	430	300	430
	42	G 1 1/2	47,9	56	60,5	2,5	22	14,7	-	600	510	360	510	360	510	
	S	6-8	G 1/4	13,2	20	20,7	1,5	12	10,2	-	55	55	25	55	25	55
		10-12	G 3/8	16,7	23	24,5	2	12	10,4	-	85	80	40	80	40	80
		14-16	G 1/2	21	28	29,6	2,5	14	13,1	-	150	110	75	110	75	110
		20	G 3/4	26,5	33	36,9	2,5	16	13,5	-	280	170	120	170	120	170
		25	G 1	33,3	41	46,1	2,5	18	14,7	-	330	330	230	330	230	330
		30	G 1 1/4	42	51	54	2,5	20	14,7	-	510	430	300	430	300	430
38		G 1 1/2	47,9	56	60,5	2,5	22	14,7	-	680	510	360	510	360	510	
JIC 37° - BS 5200	6	G 1/8	9,8	15	17,2	1	8	7,5	20	-	20	-	20	-	20	
	8-10	G 1/4	13,2	20	20,7	1,5	12	10,2	35	-	45	-	45	-	45	
	12	G 3/8	16,7	23	24,5	2	12	10,4	70	-	70	-	70	-	70	
	14-15-16	G 1/2	21	28	29,6	2,5	14	13,1	85	-	85	-	85	-	85	
	-	G 5/8	23	31	-	2,5	16	-	105	-	-	-	-	-	-	
	18-20	G 3/4	26,5	33	36,9	2,5	16	13,5	120	-	170	-	170	-	170	
	25	G 1	33,3	41	46,1	2,5	18	14,7	180	-	330	-	330	-	330	
	30-32	G 1 1/4	42	51	54	2,5	20	14,7	260	-	430	-	430	-	430	
38	G 1 1/2	47,9	56	60,5	2,5	22	14,7	290	-	510	-	510	-	510		
-	G 2	59,7	69	73,3	3	24	-	380	-	640	-	640	-	640		
ORFS	6	G 1/8	9,8	15	17,2	1	8	7,5	-	-	20	-	20	-	20	
	8-10	G 1/4	13,2	20	20,7	1,5	12	10,2	-	-	55	-	55	-	55	
	12	G 3/8	16,7	23	24,5	2	12	10,4	-	-	80	-	80	-	80	
	14-15-16	G 1/2	21	28	29,6	2,5	14	13,1	-	-	110	-	110	-	110	
	18-20	G 3/4	26,5	33	36,9	2,5	16	13,5	-	-	170	-	170	-	170	
	22-25	G 1	33,3	41	46,1	2,5	18	14,7	-	-	330	-	330	-	330	
	28-30-32	G 1 1/4	42	51	54	2,5	20	14,7	-	-	430	-	430	-	430	
	35-38	G 1 1/2	47,9	56	60,5	2,5	22	14,7	-	-	510	-	510	-	510	

Performance:

-pressure capacity
 -sealing characteristics
 -additional sealing required
 -safety factor

Sealing form A

good
 good
 no
 2,5:1

Sealing form B:

good
 good
 no
 2,5:1

Sealing form E:

excellent
 excellent
 no
 4:1

Sealing form G:

excellent
 excellent
 no
 4:1

Sealing form H:

excellent
 excellent
 no
 4:1

Notes: The values in the tightening tables are approximate and derive from practical tests run at the laboratory in Casalgrasso (CN), which may vary based on the materials and tolerances of the components used.

STUD ENDS WITH METRIC THREAD

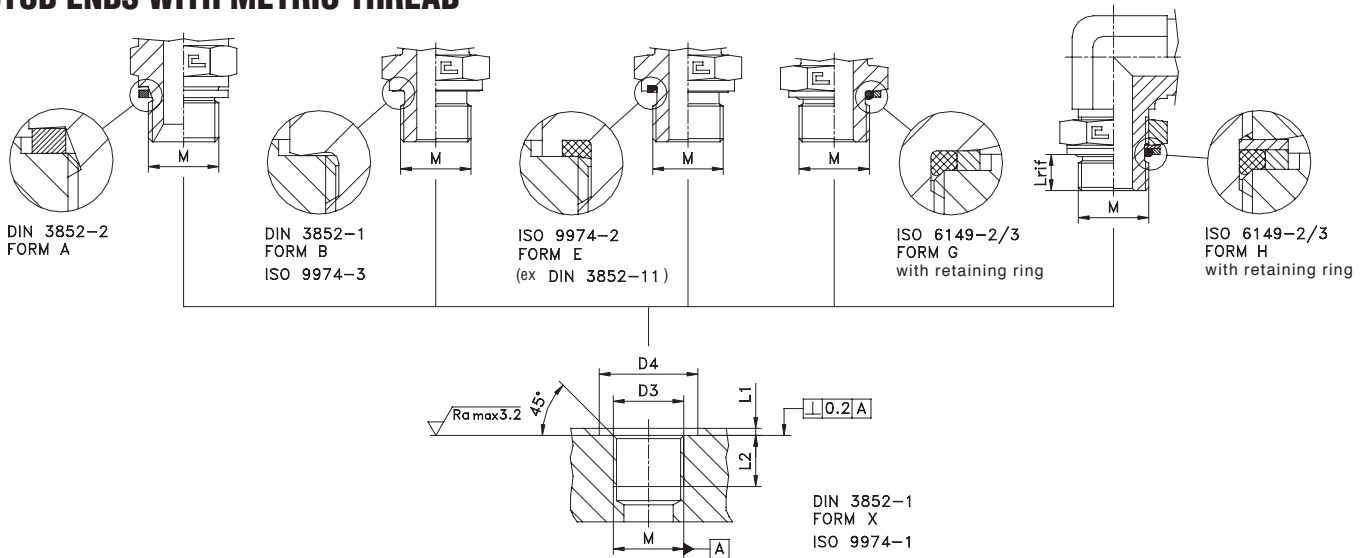

Series	Ø Tube	Thread Gas	D3	D4 min		L1 max	L2 min	L ref	Torque [Nm] ^{+10%}							
				form A/B/E	form G/H				form A	form B	form E	form E (caps 1076..)	form G	form G (caps 1078..)	form H	
DIN	L	6	M10x1	10	15	16	1	8	7,6	-	20	20	10	20	10	20
		8	M12x1,5	12	18	19	1,5	12	9,7	-	30	30	20	30	20	30
		10	M14x1,5	14	20	21	1,5	12	9,7	-	45	45	35	50	35	50
		12	M16x1,5	16	23	24	1,5	12	10,2	-	60	55	40	55	40	55
		15	M18x1,5	18	25	26	2	12	10,9	-	80	70	45	70	45	70
		18	M22x1,5	22	28	29	2,5	14	12	-	130	120	90	120	90	120
		22	M26x1,5	26	33	-	2,5	16	-	-	180	170	120	-	120	-
		22	M27x2	27	33	35	2,5	16	13,8	-	-	-	120	170	120	170
		28	M33x2	33	41	43	2,5	18	13,8	-	330	330	230	330	230	330
	35	M42x2	42	51	52	2,5	20	13,8	-	470	430	300	430	300	430	
	42	M48x2	48	56	57	2,5	22	15,3	-	600	510	360	510	360	510	
	S	6	M12x1,5	12	18	19	1,5	12	9,7	-	40	40	20	40	20	40
		8	M14x1,5	14	20	21	1,5	12	9,7	-	55	55	35	55	35	55
		10	M16x1,5	16	23	24	1,5	12	10,2	-	80	70	40	70	40	70
		12	M18x1,5	18	25	26	2	12	10,9	-	105	85	45	85	45	85
		14	M20x1,5	20	27	28	2	14	12	-	150	120	85	120	85	120
		16	M22x1,5	22	28	29	2,5	14	12	-	170	130	90	130	90	130
		20	M27x2	27	33	35	2,5	16	13,8	-	200	170	120	170	120	170
25		M33x2	33	41	43	2,5	18	13,8	-	390	330	230	330	230	330	
30		M42x2	42	51	52	2,5	20	13,8	-	510	430	300	430	300	430	
38	M48x2	48	56	57	2,5	22	15,3	-	680	510	360	510	360	510		
JIC 37° - BS 5200	6	M10x1	10	15	16	1	8	7,6	20	-	20	-	20	-	20	
	8	M12x1,5	12	18	19	1,5	12	9,7	30	-	30	-	30	-	30	
	10	M14x1,5	14	20	21	1,5	12	9,7	45	-	45	-	45	-	45	
	12	M16x1,5	16	23	24	1,5	12	10,2	60	-	55	-	55	-	55	
	14-15-16	M18x1,5	18	25	26	2	12	10,9	80	-	70	-	70	-	70	
	14-15-16	M20x1,5	20	27	28	2	14	12	105	-	105	-	105	-	105	
	14-15-16	M22x1,5	22	28	29	2,5	14	12	130	-	120	-	120	-	120	
	-	M26x1,5	26	33	-	2,5	16	-	160	-	-	-	-	-	-	
	18-20	M27x2	27	33	35	2,5	16	13,8	-	-	170	-	170	-	170	
	-	M30x1,5	30	37	-	2,5	-	-	190	-	-	-	-	-	-	
	22-25	M33x2	33	41	43	2,5	18	13,8	-	-	330	-	330	-	330	
	-	M38x1,5	38	45	-	2,5	-	-	230	-	-	-	-	-	-	
	28-30-32	M42x2	42	51	52	2,5	20	13,8	-	-	430	-	430	-	430	
-	M45x1,5	45	53	-	2,5	-	-	280	-	-	-	-	-	-		
35-38	M48x2	48	56	57	2,5	22	15,3	-	-	510	-	510	-	510		
ORFS	6	M10x1	10	15	16	1	8	8,6	-	-	20	-	20	-	20	
	8-10	M12x1,5	12	18	19	1,5	12	9,7	-	-	40	-	40	-	40	
	8-10	M14x1,5	14	20	21	1,5	12	9,7	-	-	55	-	55	-	55	
	12	M16x1,5	16	23	24	1,5	12	11,2	-	-	70	-	70	-	70	
	14-15-16	M18x1,5	18	25	26	2	12	12,4	-	-	85	-	85	-	85	
	14-15-16	M22x1,5	22	28	29	2,5	14	14	-	-	130	-	130	-	130	
	18-20	M27x2	27	33	35	2,5	16	16,3	-	-	170	-	170	-	170	
	22-25	M33x2	33	41	43	2,5	18	16,3	-	-	330	-	330	-	330	
	28-30-32	M42x2	42	51	52	2,5	20	16,8	-	-	430	-	430	-	430	
	35-38	M48x2	48	56	57	2,5	22	19,3	-	-	510	-	510	-	510	

Performance:	Sealing form A	Sealing form B:	Sealing form E:	Sealing form G:	Sealing form H:
-pressure capacity	good	good	excellent	excellent	excellent
-sealing characteristics	good	good	excellent	excellent	excellent
-additional sealing required	no	no	no	no	no
-safety factor	2,5:1	2,5:1	4:1	4:1	4:1

Notes: The values in the tightening tables are approximate and derive from practical tests run at the laboratory in Casalgrasso (CN), which may vary based on the materials and tolerances of the components used.

STUD ENDS WITH METRIC THREAD (ISO 6149)

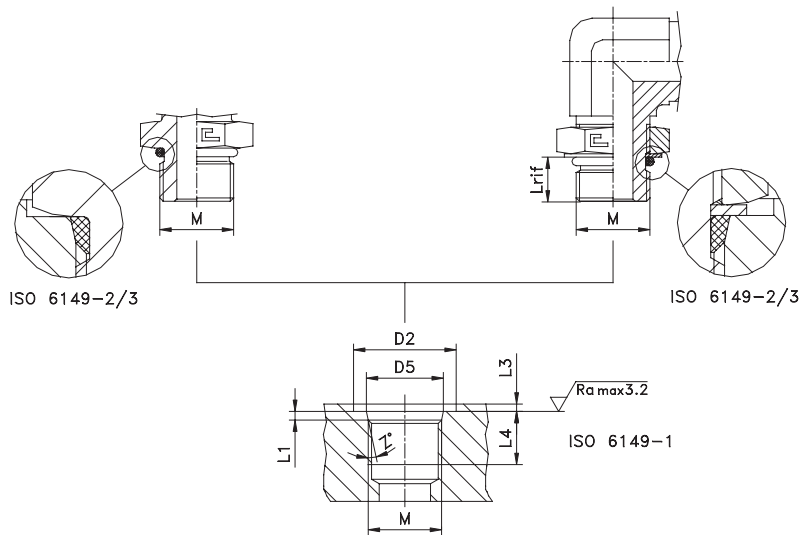

Series	Maximum working pressure (bar)		Ø Tube	Metric Thread	D2 min	D5	L1	L3 max	L4 min	L rif	Z°	Torque [Nm] ^{+10%} ₀		
	ISO 6149 STRAIGHT	ISO 6149 SWIVEL										ISO 6149 STRAIGHT	ISO 6149 SWIVEL	
DIN	L	315	315	6	M10x1	16	11,1	1,6	1	10	8,6	12	15	15
		315	315	8	M12x1,5	19	13,8	2,4	1,5	11,5	11,1	15	25	25
		315	315	10	M14x1,5	21	15,8	2,4	1,5	11,5	11,1	15	30	30
		315	250	12	M16x1,5	24	17,8	2,4	1,5	13	11,6	15	35	35
		315	250	15	M18x1,5	26	19,8	2,4	2	14,5	12,3	15	40	40
		315	250	18	M22x1,5	29	23,8	2,4	2	15,5	13,4	15	55	55
		160	160	22	M27x2	34	29,4	3,1	2	19	15,8	15	85	85
		160	160	28	M33x2	43	35,4	3,1	2,5	19	15,8	15	140	140
		160	160	35	M42x2	52	44,4	3,1	2,5	19,5	15,8	15	180	180
	160	160	42	M48x2	57	50,4	3,1	2,5	22	17,3	15	230	230	
	S	630	400	6	M12x1,5	19	13,8	2,4	1,5	11,5	11,1	15	30	30
		630	400	8	M14x1,5	21	15,8	2,4	1,5	11,5	11,1	15	40	40
		630	400	10	M16x1,5	24	17,8	2,4	1,5	13	11,6	15	50	50
		630	400	12	M18x1,5	26	19,8	2,4	2	14,5	12,3	15	60	60
		400	400	14	M20x1,5	27	21,8	2,4	2	14,5	13,4	15	70	70
		400	400	16	M22x1,5	29	23,8	2,4	2	15,5	13,4	15	85	85
		400	400	20	M27x2	34	29,4	3,1	2	19	15,8	15	150	150
		400	315	25	M33x2	43	35,4	3,1	2,5	19	15,8	15	260	260
250		250	30	M42x2	52	44,4	3,1	2,5	19,5	15,8	15	280	280	
250	200	38	M48x2	57	50,4	3,1	2,5	22	17,3	15	360	360		
JIC 37° - BS 5200	400	315	6	M10x1	16	11,1	1,6	1	10	8,6	12	15	15	
	400	315	8-10	M12x1,5	19	13,8	2,4	1,5	11,5	11,1	15	25	25	
	350	315	8-10	M14x1,5	21	15,8	2,4	1,5	11,5	11,1	15	30	30	
	315	250	12	M16x1,5	24	17,8	2,4	1,5	13	11,6	15	35	35	
	315	250	14-15-16	M18x1,5	26	19,8	2,4	2	14,5	12,3	15	40	40	
	315	250	14-15-16	M20x1,5	27	21,8	2,4	2	14,5	13,4	15	50	50	
	315	250	14-15-16	M22x1,5	29	23,8	2,4	2	15,5	13,4	15	55	55	
	200	160	18-20	M27x2	34	29,4	3,1	2	19	15,8	15	85	85	
	200	160	22-25	M33x2	43	35,4	3,1	2,5	19	15,8	15	140	140	
	200	160	28-30-32	M42x2	52	44,4	3,1	2,5	19,5	15,8	15	180	180	
	200	160	35-38	M48x2	57	50,4	3,1	2,5	22	17,3	15	230	230	
	ORFS	630	400	6	M10x1	16	11,1	1,6	1	10	9,6	12	15	15
630		400	8-10	M12x1,5	19	13,8	2,4	1,5	11,5	11,1	15	30	30	
630		400	8-10	M14x1,5	21	15,8	2,4	1,5	11,5	11,1	15	40	40	
630		400	12	M16x1,5	24	17,8	2,4	1,5	13	12,6	15	50	50	
630		400	14-15-16	M18x1,5	26	19,8	2,4	2	14,5	12,3	15	60	60	
400		400	14-15-16	M22x1,5	29	23,8	2,4	2	15,5	15,4	15	85	85	
400		400	18-20	M27x2	34	29,4	3,1	2	19	18,3	15	150	150	
400		315	22-25	M33x2	43	35,4	3,1	2,5	19	18,3	15	260	260	
250		250	28-30-32	M42x2	52	44,4	3,1	2,5	19,5	18,8	15	280	280	
250		250	35-38	M48x2	57	50,4	3,1	2,5	22	21,3	15	360	360	

Performance:

- pressure capacity
- sealing characteristics
- additional sealing required
- safety factor

Seal STRAIGHT:

- excellent
- excellent
- no
- 4:1

Seal SWIVEL:

- excellent
- excellent
- no
- 4:1

Note: 1) To obtain the ISO 6149 type of sealing please take out the retaining ring from the standard fitting.
 2) The values in the tightening tables are approximate and derive from practical tests run at the laboratory in Casalgrasso (CN), which may vary based on the materials and tolerances of the components used.

STUD END WITH UNF/UN-2A THREAD

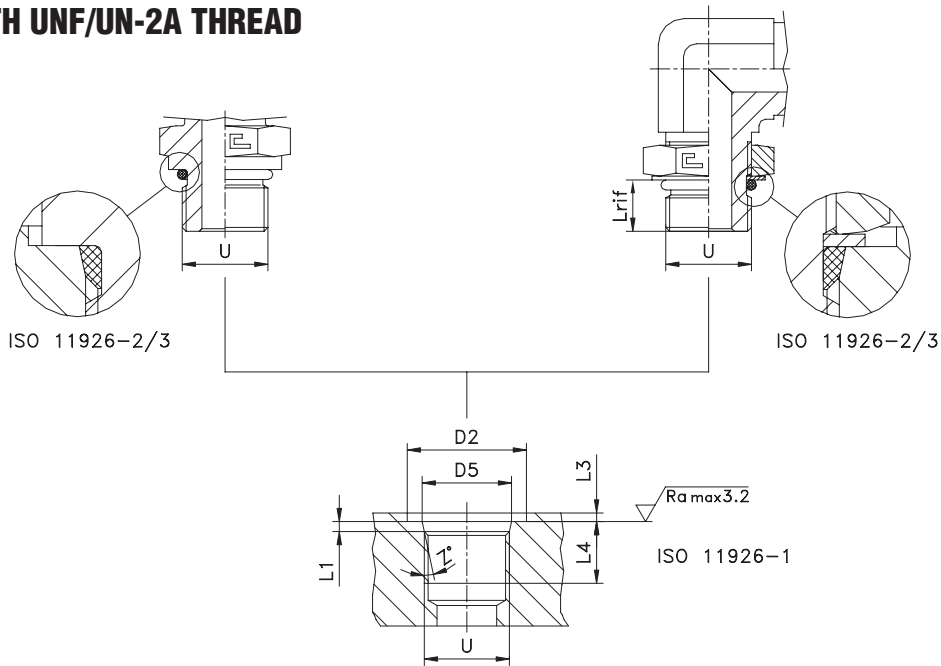

Series	Ø Tube	UnF/Un thread	D2 min	D5	L1	L3 max	L4 min	L rif	Z°	Torque [Nm] ^{+10%} ₀		
										STRAIGHT	SWIVEL	
DIN	L	6	7/16-20 UNF-2A	21	12,45	2,4	1,6	11,5	9,9	12	20	20
		8-10	1/2-20 UNF-2A	23	14,05	2,4	1,6	11,5	9,9	12	25	25
		12	9/16-18 UNF-2A	25	15,7	2,5	1,6	12,7	11,1	12	30	30
		15-18	3/4-16 UNF-2A	30	20,65	2,5	2,4	14,3	12,5	15	45	45
		18	7/8-14 UNF-2A	34	24	2,5	2,4	16,7	14,5	15	55	55
		22	1 1/16-12 UN-2A	41	29,2	3,3	2,4	19	16,8	15	85	85
		28	1 5/16-12 UN-2A	49	35,55	3,3	3,2	19	16,8	15	130	130
	S	35	1 5/8-12 UN-2A	58	43,55	3,3	3,2	19	16,8	15	170	170
		42	1 7/8-12 UN-2A	65	49,9	3,3	3,2	19	16,8	15	180	180
		6-8	1/2-20 UNF-2A	23	14,05	2,4	1,6	11,5	9,9	12	25	25
		10-12	9/16-18 UNF-2A	25	15,7	2,5	1,6	12,7	11,1	12	35	35
		14-16	3/4-16 UNF-2A	30	20,65	2,5	2,4	14,3	12,5	15	60	60
		16	7/8-14 UNF-2A	34	24	2,5	2,4	16,7	14,5	15	85	85
		20	1 1/16-12 UN-2A	41	29,2	3,3	2,4	19	16,8	15	150	150
JIC 37°	25	1 5/16-12 UN-2A	49	35,55	3,3	3,2	19	16,8	15	230	230	
	30	1 5/8-12 UN-2A	58	43,55	3,3	3,2	19	16,8	15	250	250	
	38	1 7/8-12 UN-2A	65	49,9	3,3	3,2	19	16,8	15	320	320	
	6	7/16-20 UNF-2A	21	12,45	2,4	1,6	11,5	9,9	12	20	20	
	8	1/2-20 UNF-2A	23	14,05	2,4	1,6	11,5	9,9	12	25	25	
	10	9/16-18 UNF-2A	25	15,7	2,5	1,6	12,7	11,1	12	30	30	
	12	3/4-16 UNF-2A	30	20,65	2,5	2,4	14,3	12,5	15	45	45	
	14-15-16	7/8-14 UNF-2A	34	24	2,5	2,4	16,7	14,5	15	55	55	
ORFS	18-20	1 1/16-12 UN-2A	41	29,2	3,3	2,4	19	16,8	15	85	85	
	25	1 5/16-12 UN-2A	49	35,55	3,3	3,2	19	16,8	15	130	130	
	30-32	1 5/8-12 UN-2A	58	43,55	3,3	3,2	19	16,8	15	170	170	
	38	1 7/8-12 UN-2A	65	49,9	3,3	3,2	19	16,8	15	180	180	
	6	7/16-20 UNF-2A	21	12,45	2,4	1,6	11,5	11,4	12	20	20	
	8-10	9/16-18 UNF-2A	25	15,7	2,5	1,6	12,7	12,2	12	35	55	
	12	3/4-16 UNF-2A	30	20,65	2,5	2,4	14,3	13,8	15	60	60	
	14-15-16	7/8-14 UNF-2A	34	24	2,5	2,4	16,7	16,3	15	85	85	
18-20	1 1/16-12 UN-2A	41	29,2	3,3	2,4	19	18,6	15	150	150		
22-25	1 5/16-12 UN-2A	49	35,55	3,3	3,2	19	18,6	15	230	230		
28-30-32	1 5/8-12 UN-2A	58	43,55	3,3	3,2	19	18,6	15	250	250		
35-38	1 7/8-12 UN-2A	65	49,9	3,3	3,2	19	18,6	15	320	320		

Performance:

- pressure capacity
- sealing characteristics
- additional sealing required
- safety factor

Seal STRAIGHT:

- excellent
- excellent
- no
- 4:1

Seal SWIVEL:

- excellent
- excellent
- no
- 4:1

Note: The values in the tightening tables are approximate and derive from practical tests run at the laboratory in Casalgrasso (CN), which may vary based on the materials and tolerances of the components used.

STUD ENDS WITH BSPT THREAD

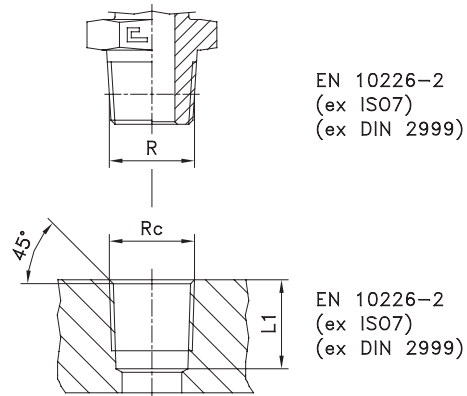
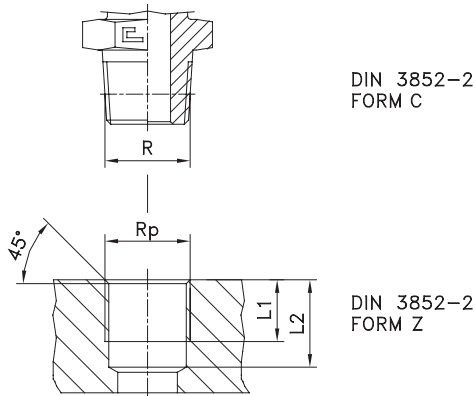

Series	Ø Tube	BsPt thread (DIN 3852-2 form C)	L1	L2	
DIN	L	6	R 1/8	5,5	8,5
		8-10	R 1/4	8,5	12,5
		12	R 3/8	8,5	12,5
		15-18	R 1/2	10,5	16,5
		22	R 3/4	13	19
		28	R 1	-	-
		35	R 1 1/4	-	-
	S	42	R 1 1/2	-	-
		6-8	R 1/4	8,5	12,5
		10-12	R 3/8	8,5	12,5
		14-16	R 1/2	10,5	16,5
		20	R 3/4	13	19
		25	R 1	-	-
		30	R 1 1/4	-	-
38	R 1 1/2	-	-		

Series	Ø Tube	BSPT thread (EN 10226-2)	L1
JIC 37°	6	R 1/8	7,4
	8	R 1/4	11
	10	R 3/8	11,4
	12-14-15-16	R 1/2	15
	18-20	R 3/4	16,3
	25	R 1	19,1
	30-32	R 1 1/4	21,4
	38	R 1 1/2	21,4
BS 5200	-	R 1/8	7,4
	-	R 1/4	11
	-	R 3/8	11,4
	-	R 1/2	15
	-	R 3/4	16,3
	-	R 1	19,1
	-	R 1 1/4	21,4
	-	R 1 1/2	21,4
-	R 2	25,7	

Performance:
-pressure capacity
-sealing characteristics
-additional sealing required
-safety factor

Sealing form C:
low-medium
low-medium
Yes
2,5:1

Performance:
-pressure capacity
-sealing characteristics
-additional sealing required
-safety factor

Taper sealing:
low-medium
low-medium
Yes
2,5:1

STUD ENDS WITH BSPT THREAD

Serie	Ø Tubo	Thread Metric Taper	L1	L2	
DIN	L	6	M10x1 keg	5,5	10
		8	M12x1,5 keg	8,5	13,5
		10	M14x1,5 keg	8,5	13,5
		12	M16x1,5 keg	8,5	13,5
		15	M18x1,5 keg	8,5	13,5
		18	M22x1,5 keg	10,5	15,5
	S	6	M12x1,5 keg	8,5	13,5
		8	M14x1,5 keg	8,5	13,5
		10	M16x1,5 keg	8,5	13,5
		12	M18x1,5 keg	8,5	13,5
		14	M20x1,5 keg	10,5	15,5
		16	M22x1,5 keg	10,5	15,5

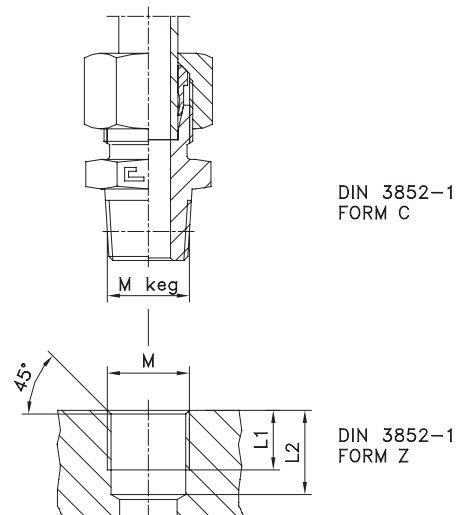

Performance:
-pressure capacity
-sealing characteristics
-additional sealing required
-safety factor

Taper sealing C:
low-medium
low-medium
Yes
2,5:1

STUD ENDS WITH NPT/NPTF THREAD

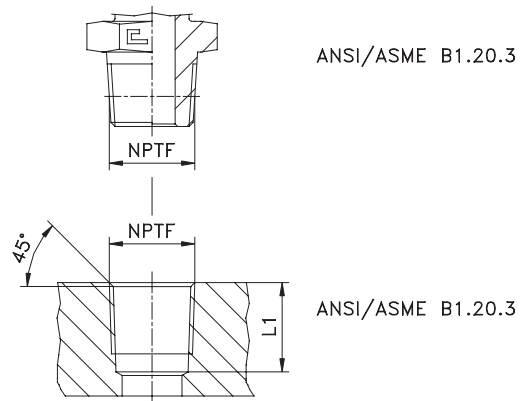
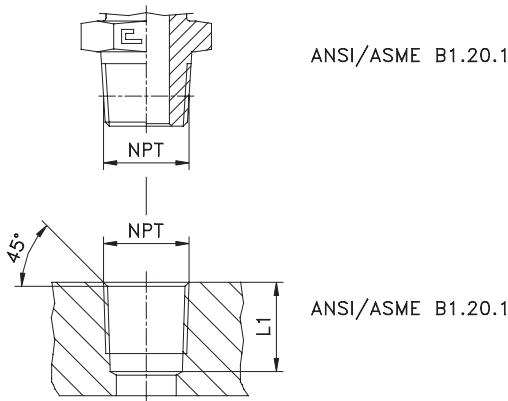

Series	Ø Tube	NPT thread	L1	
DIN	L	6	1/8-27 NPT	11,6
		8-10	1/4-18 NPT	16,4
		12	3/8-18 NPT	17,4
		15-18	1/2-14 NPT	22,6
		22	3/4-14 NPT	23,1
		28	1-11,5 NPT	27,8
		35	1 1/4-11,5 NPT	28,3
		42	1 1/2-11,5 NPT	28,3
	S	6-8	1/4-18 NPT	16,4
		10-12	3/8-18 NPT	17,4
		14-16	1/2-14 NPT	22,6
		20	3/4-14 NPT	23,1
		25	1-11,5 NPT	27,8
		30	1 1/4-11,5 NPT	28,3
BS 5200	-	1/8-27 NPT	11,6	
	-	1/4-18 NPT	16,4	
	-	3/8-18 NPT	17,4	
	-	1/2-14 NPT	22,6	
	-	3/4-14 NPT	23,1	
	-	1-11,5 NPT	27,8	
	-	1 1/4-11,5 NPT	28,3	
	-	1 1/2-11,5 NPT	28,3	
-	2-11,5 NPT	29		

Series	Ø Tube	NPTF thread	L1
JIC 37° - ORFS	6-8	1/8-27 NPTF	11,6
	8-10	1/4-18 NPTF	16,4
	12	3/8-18 NPTF	17,4
	14-15-16	1/2-14 NPTF	22,6
	18-20	3/4-14 NPTF	23,1
	22-25	1-11,5 NPTF	27,8
	28-30-32	1 1/4-11,5 NPTF	28,3
	35-38	1 1/2-11,5 NPTF	28,3

Performance:
 -pressure capacity
 -sealing characteristics
 -additional sealing required
 -safety factor

Taper sealing:
 low-medium
 low-medium
 Yes
 2,5:1

Performance:
 -pressure capacity
 -sealing characteristics
 -additional sealing required
 -safety factor

Taper sealing:
 low-medium
 low-medium
 Yes
 2,5:1

• PRESCRIPTIONS TO COMPLY WITH FOR ALL THE SERIES

- Only use CAST products and components for the same assembly to prevent claims and damage to people and objects.
- Apply completely the general instructions, utilisation standards, safety factors, assembly instructions and working pressures for the specific fitting used.
- Closely respect the working temperature ranges, the relevant pressure changes reported and stay within the set values in bars.
- Respect the indicated tightening values as well as the assembly instructions.
- Lubricate all the components, as indicated in the assembly instructions, with specific products.
- All carbon steel connections must be pre-assembled before being mounted onboard the machine. It is not allowed to assemble them directly on the machine.
- All stainless steel connections must be pre-assembled or flared with hardened tools before being mounted onboard the machine. It is not allowed to assemble them directly on the machine.
- Only use the carbon steel and stainless steel tubes mentioned on pages 25 and 26.
- Use support sleeves on thin tubes.
- It is not advisable to mix carbon and stainless steel components together in the same connection.
- Always check the correct alignment of the system, tubes, connections and actuators.
- It is mandatory to always check the correct incision of the cutting ring on the tube!
- Thoroughly check the collapse of the fitting hole (insert) with the prescribed "P-N P" buffers to ensure the correct stapling of the tube, fitting and sleeve for series 80
- The use of non-compliant tubes, fittings or connections is not allowed.
- It is not allowed to alter CAST products in any way.
- Fully comply with all the indications contained in this Technical Commercial Catalogue.
- In case of doubt always follow the principle of prudence

Failure to follow any of these prescriptions may alter the functionality of the products and void any guarantee.



It is not allowed to mix and use components from production of different manufacturers of oleo-dynamic fittings. The product traceability coding applies.



Users are not allowed to made changes to or repair the oleo-dynamic fittings we manufacture; in such case lawbreakers will be liable for their actions and any damage caused to the environment, people and objects.



Fluids under pressure may cause serious damage to people and objects; it is thus necessary to always pay the utmost attention, fully respecting the applicable prescriptions and adopting the principle of prudence to avoid any accident to oneself and the others.

• PRODUCT LIABILITY - VALID FOR ALL THE SERIES

Pres. Decree 224- EEC 85/347 states that: "... the responsibility will be charged to the negligent part ... ". This means that the manufacturer will be held legally liable only if the product actually proves faulty in terms of project, execution/production due to negligence or malice.

The distributor making the sale must make sure that its customer is aware of all the technical issues relating the product, such as assembly instructions, and that the product is used for the right applications.

Likewise the End User will be considered liable if, due to negligence, superficiality or malice, he/she did not scrupulously follow the Manufacturer's prescriptions (Commercial Technical Catalogue), which must be provided to him/her as technical support by the Distributor selling the product. Should the end user be lack this technical documentation, our offices will be glad to send it to him/her.

By virtue of this legal regulation, CAST S.p.A. declines any responsibility in case the user fails to strictly and entirely comply with the GENERAL INSTRUCTIONS, UTILISATION STANDARDS, SAFETY FACTORS, ASSEMBLY INSTRUCTIONS, WORKING PRESSURES as well as any other technical indication clearly stated in this Commercial Technical Catalogue and/or the product was changed or altered by anyone other than CAST S.p.A.. Failure to respect these imperative prescriptions or any changes made may alter the functionality of the products and void any guarantee. The mentioned regulation provides for an excess of €500.00.

ASSEMBLY INSTRUCTIONS ACCORDING TO DIN 3859-2 FOR B3 - B4 - BP

1. Before pre-assembly, make sure that all the tools to be used are in perfect working order. Replace any non-complying tool.
2. The segment of the tube to be pre-assembled must have a straight section at least twice the length of the nut (length H). Roundness must comply with DIN 2391.
3. Cut the tube square by using an appropriate hack-saw (do not use roller type tube cutters). Check that the cut is properly made at 90°. Remove any internal and external burrs.
4. Oil the 24° cone, the thread of the body, the cutting ring and the nut with suitable products. = →
5. Fit the nut and the cutting ring on the tube as shown. The larger diameter of the cutting ring must face the nut.
6. Insert the tube on the 24° cone until it comes into contact with the stop. Tighten the nut by hand until the cutting ring rests firmly on the nut. Then tighten the nut with a wrench until the cutting edge of the ring is in contact with the tube and prevents rotation of this.
7. Holding the tube against its stop and making sure it does not rotate, tighten the nut by 3/4 of a turn. This way, the cutting edge of the ring cuts into the outer part of the tube for the necessary depth and raises an edge in front of its cutting edge while the second cutting edge clinches the tube at the same time.
8. Loosen the nut and check that there is a clearly raised edge all round the tube. The edge must cover 80% of the front of the cutting ring according to DIN 3859 part II. This check is peremptory for the safety of all concerned!!! If the raised edge is not satisfactory, pre-assembly must be repeated.
9. If pre-assembly has been carried out correctly, fit the tube on the machine, close with a wrench until a certain resistance is encountered and then tighten for a further 1/4 turn with wrench to wrench contrast.
10. ISO 19879 envisages a maximum of six couplings to be made on the same connection opening. Increase the blocking by 15° at every closure.
11. All the pre-assembly of stainless steel fittings must be performed with hardened tools (blocks or machines).

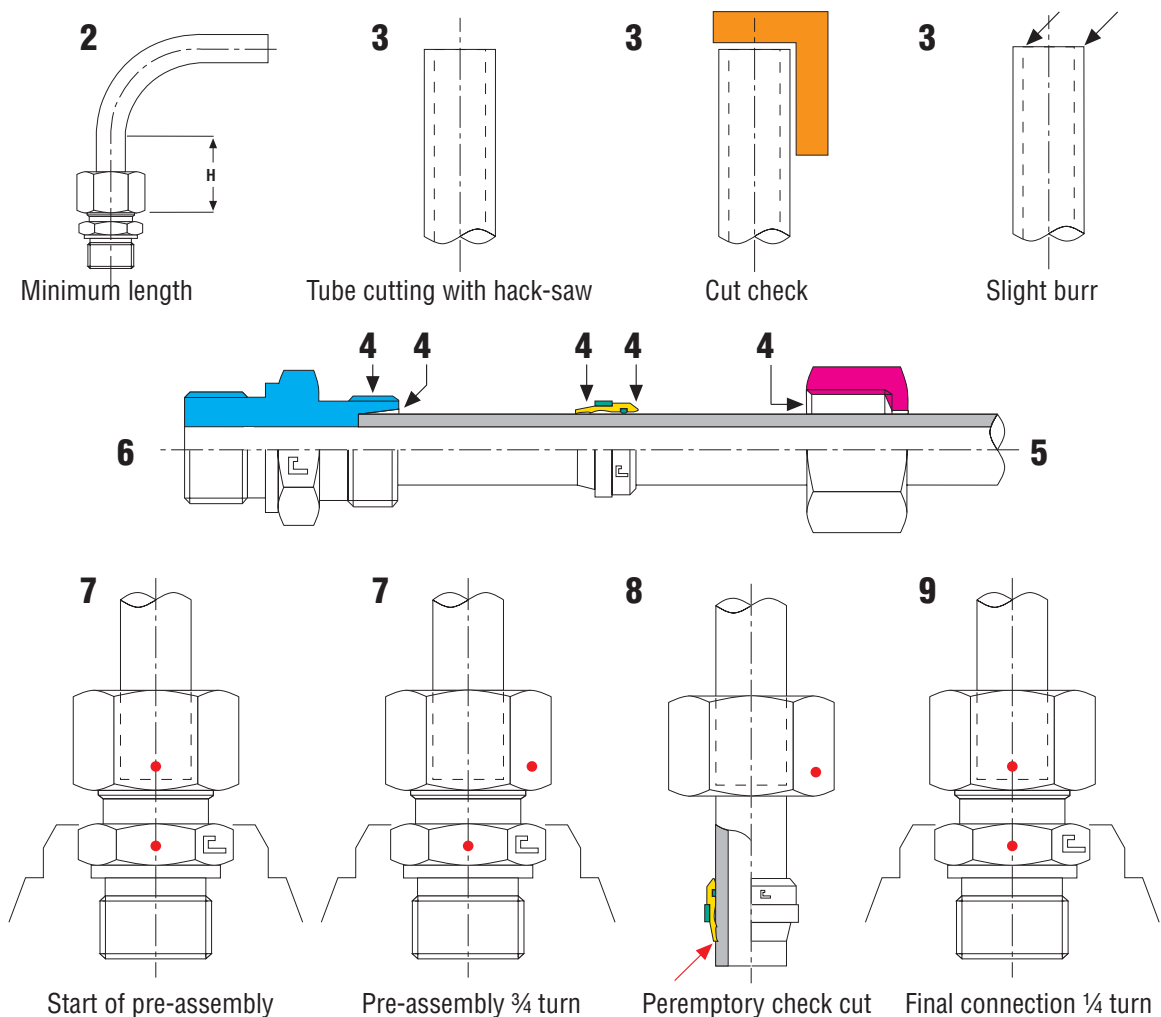

PRESCRIPTIONS FOR THE INSTALLATION OF RIGID TUBES

To ensure the correct cabling of an oleo-dynamic system made of (steel) rigid tubes for high pressures it is necessary to respect the provisions of the standards and of the manufacturer of the fittings. Only use high quality tubes and related fittings, scrupulously complying with the maximum working pressures and temperatures allowed. Correctly assemble the selected tubes, using collars that fit the size of the tubes. Do not fasten the tubes to electric conduits or other tubes.

When arranging the system, take into account the space needed for maintenance interventions. The tube support must be created according to the tables below. It is important to obtain the correct alignment between tubes, fittings and actuators. An aesthetically well structured system is synonym with functionality and safety.

Some examples of correct installation:

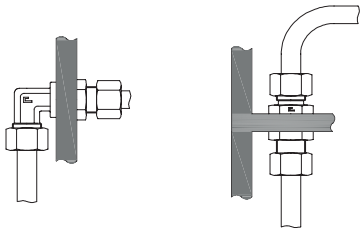

Properly fasten the fittings that host the tubes

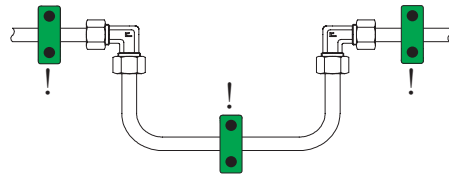

Do not excessively fasten the tubes as these must always be allowed to dilate without any problem

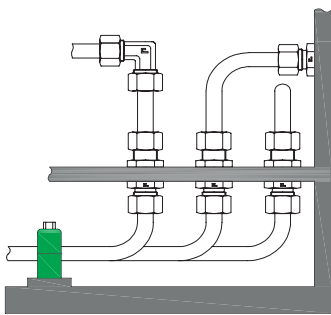

Do not overlay the tubes to facilitate maintenance

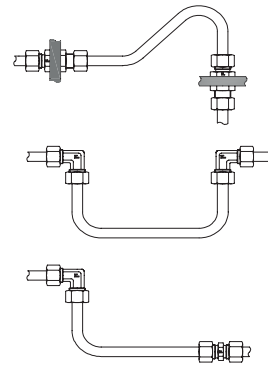

Do not subject the fittings to stress deriving from a poor alignment of the tube which must be able to expand

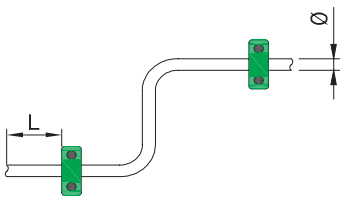

Follow the table indicated as closely as possible.

Ø Tube (mm)	L (mt)
6-12	0,5
12-22	0,6
22-32	0,7
32-38	1,0
38-42	1,3

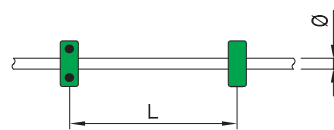

Follow the table indicated as closely as possible.

Ø Tube (mm)	L (mt)
6-12	1,0
12-22	1,2
22-32	1,5
32-38	2,0
38-42	2,7

CAST NON RETURN VALVE

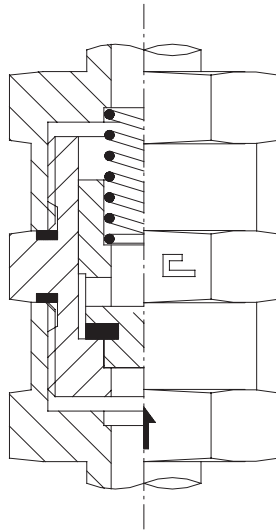

THEORY OF OPERATION

Cast S.p.A. non return valve is used in all those circuits where the fluid must flow in one way only, avoiding the flow in the opposite direction

TO OBTAIN PERFECT SEALING:

1. Make sure that all tubes are perfectly clean and that there are no impurities in the system where the fluid will flow.
2. Remove protective caps only when ready to assemble, making sure that in the assembly phase no impurities enter the system.

TECHNICAL CHARACTERISTICS

1. Cast S.p.A. non return valve assures a perfect tightness of the circuit, provided that the indicated nominal working pressures are kept as referred to in this catalogue.
2. The particular profile of its inner elements assures the correct flow with a minimum pressure drop.
3. The valve is a compact, particularly sturdy element; the seal is obtained by a plain seat metal to metal plug with an elastomeric seal gasket assuring tightness at low working pressures.
4. A basic body allows to different types of non return valves to be interchanged by applying, from time to time, the different engaged stud ends as chosen by the customer, allowing for easy logistic of the stock.
5. The valve may be used for conveying mineral oils, fuels, compressed air or gases. When ordering please specify if the fluid needs specific type of gaskets.
6. The nominal working temperature is between -40C° and $+120\text{C}^{\circ}$ Celsius degrees for carbon steel, and between -60C° and $+200\text{C}^{\circ}$ Celsius degrees for stainless steel. The limit may change according to the type of gasket used.

TECHNICAL DATA

Maximum advised flow speed is 5mt/sec. The standard opening pressure is 1 bar; if specified when ordering, we can supply non return valves with an opening pressure up to 3 bars with 0.5 bar steps.

COMPONENT TESTING

All the valves are checked for leaks at low pressure and at the opening value; high pressure tests are carried out at the maximum nominal working pressures plus 33%.

TIGHTENING TORQUES FOR B3, B4 AND BP CUTTING RINGS

DIN 3861 cone for carbon and stainless steel

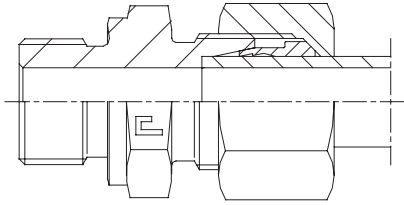

Assembly of B3 ring on fitting body

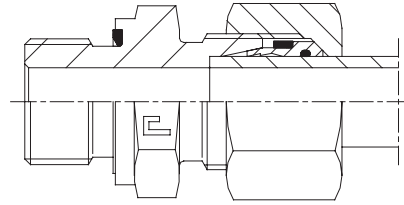

Assembly of B4 ring on fitting body

Series	Ø Tube	Metric thread	Manual carbon (Nm)	Manual Stainless (Nm)	Machine carbon (Kg)	Machine Stainless (Kg)
L	6	M12x1,5	20	30	1200	1400
	8	M14x1,5	25	55	1400	1700
	10	M16x1,5	30	85	2000	2200
	12	M18x1,5	40	120	2100	2400
	15	M22x1,5	60	130	2400	3300
	18	M26x1,5	90	220	2500	3600
	22	M30x2	170	320	2600	3800
	28	M36x2	210	500	3000	6900
	35	M45x2	360	970	5500	10000
	42	M52x2	490	1110	6700	12500
S	6	M14x1,5	25	45	1200	1400
	8	M16x1,5	30	55	1400	1700
	10	M18x1,5	40	90	2000	2200
	12	M20x1,5	50	105	2100	2400
	14	M22x1,5	70	150	2400	3300
	16	M24x1,5	80	180	2500	3600
	20	M30x2	140	340	2600	6400
	25	M36x2	230	530	5000	9300
	30	M42x2	300	610	5500	10000
	38	M52x2	430	850	6700	12500

Notes:

The values in the tightening tables are approximate and derive from practical tests run at the laboratory in Casalgrasso (CN), which may vary based on the materials and tolerances of the components used.

All the values expressed in Newton Meters (Nm) for the tightening torques on the cone DIN 3861 represent the torquing moment needed to have the correct incision of the pre-assembly of the tube, lifting the required 80% of the front of the edge of the cutting ring.

All the values expressed in Kilograms (Kg) for the linear push on the preassembly machine, represent the right strength necessary to have the correct incision of the preassembly lifting the required 80% of the front of the edge of the cutting ring.

Once the preassembly has been carried out correctly and after checking that all the components conform to the system requirements, complete the assembly on the system itself, first closing by wrench until you feel a certain resistance, and then doing the last 1/4 of a turn to close the fitting completely.

SERIES 60... SWIVEL NUT DIN 2353

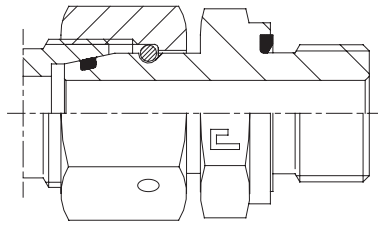

According to DIN 2353 standards, 24° cone as per DIN 3861 and o-ring seal as per DIN 3865.

This series of fittings with revolving nut and seal on the 24° cone guaranteed by an o-ring meets the requirements of customers asking for high pressure, absolute tightness and low tightening torque.

Due to its technical characteristics this type of fitting is suitable for demanding applications, such as assembly on heavy machinery. The result is a safe fastening of the nut to the body improving the whole sealing system.

The limit of this series lies in that the sealing performed with the o-ring is limited to a single connection, leaving all the others uncovered by this excellent solution.

A new step forward was needed to improve the research and find a solution that could grant a double sealing system on all the connections involved, metal to metal plus the elastomeric sealing.

This problem has been solved by CAST S.p.A. with the new “B4” cutting ring, guaranteeing a double sealing (metal and gasket) on all the connections of the fitting.

ASSEMBLY INSTRUCTIONS FOR SWIVEL CONE SERIES DIN 2353

1. Before the assembly, check for the correct parameters of all the tools to be used and substitute those not complying to the requirements.
2. Clean the nut, fitting and tube and lubricate with the suggested products.
3. Check the correct alignment of the parts involved, then using a wrench tighten until reaching the metal to metal contact of the conical parts.
4. Repeated assembly and disassembly will not alter the functionality of the system which, each time is closed, will always provide an immediate seal, which will last over time.
5. Please refer to the related tables for the correct tightening torques to be applied.

TIGHTENING TORQUES ON THE SWIVEL CONE DIN 3861 cone for carbon and stainless steel

Series	Ø Tube	Metric thread	Torque ^{+10%} ₀ (Nm)
L	6	M12x1,5	20
	8	M14x1,5	35
	10	M16x1,5	40
	12	M18x1,5	45
	15	M22x1,5	55
	18	M26x1,5	110
	22	M30x2	130
	28	M36x2	200
	35	M45x2	220
	42	M52x2	240
S	6	M14x1,5	40
	8	M16x1,5	45
	10	M18x1,5	50
	12	M20x1,5	60
	14	M22x1,5	80
	16	M24x1,5	100
	20	M30x2	160
	25	M36x2	240
	30	M42x2	260
	38	M52x2	350

Notes:

The values in the tightening tables are approximate and derive from practical tests run at the laboratory in Casalgrasso (CN), which may vary based on the materials and tolerances of the components used.

All the values expressed in Newton Meters (Nm) for the tightening torques on the swivel cone represent the torquing moment needed to obtain the correct tightness.

ASSEMBLY INSTRUCTIONS FOR ADJUSTABLE FITTINGS

**ISO 6149 Metric thread
ISO 11926 UNF/UN-2A thread**

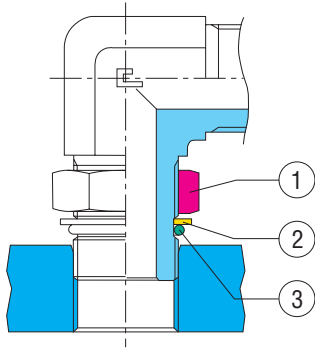

- 1 Back up hexagonal nut
- 2 Back up sleeve
- 3 O-ring
- 4 Retaining ring

**BSPP Thread (in revision phase)
ISO 6149 Metric thread
with retaining ring**

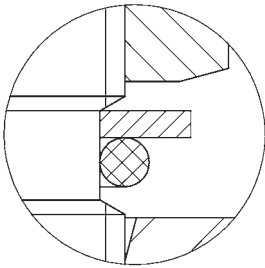
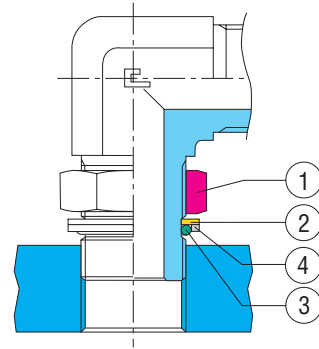

Lubricate the o-ring.
Unscrew the back up hexagonal nut and check that the back up sleeve is positioned as in the picture.
The correct position of the back up sleeve may be obtained when the fitting is screwed into the female thread.

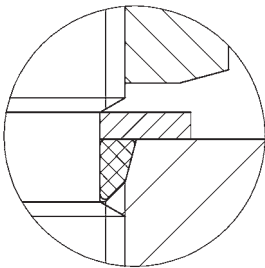
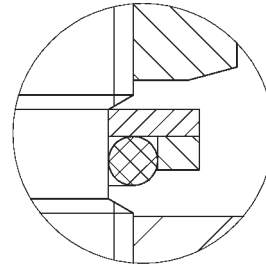

Screw the fitting up to the point where the back up sleeve or the retaining ring is in contact with the machined surface, checking that the o-ring is positioned correctly into its shaped housing.

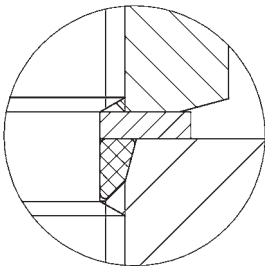
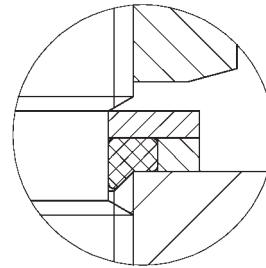

Unscrew the fitting up to a maximum of 1 turn to obtain the desired positioning.
Keep the fitting still with a wrench and block the back up hexagonal nut.
Please refer to the related tables for the correct tightening torques to be applied.

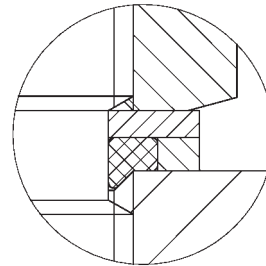

N.B. To obtain the ISO 6149 type of seal please take out the retaining ring from the standard fitting.

STAINLESS STEEL «BP» SINGLE EDGE CUTTING RING

Type: 1101..-BP

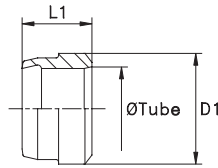

Series DIN	11.... [bar]	BP ring ordering	Ø Tube	L1	D1	
L	250	110104-BP	6	9	9	
		110105-BP	8	9	11	
		110106-BP	10	9,5	13	
		110107-BP	12	9,5	15	
		110108-BP	15	9,5	18	
	160	110109-BP	18	9,5	22	
		110110-BP	22	10,5	26	
		100	110111-BP	28	11	32
			110112-BP	35	13	41
110113-BP	42		13	48		
S	630	110104-BP	6	9	9	
		110105-BP	8	9	11	
		110106-BP	10	9,5	13	
		110107-BP	12	9,5	15	
		110118-BP	14	10	19	
	400	110119-BP	16	10,5	21	
		110120-BP	20	12	26	
		110121-BP	25	12	32	
	250	110122-BP	30	13	36	
		110123-BP	38	13	44	

“BP” CUTTING RING

This new ring (working pressure as per DIN 2353 / ISO 8434-1), due to its particular geometric configuration with acute corner cutting, allows the cabling onboard the machine in complete absence of losses, leakages or sweating. It may be assembled on all the fittings with opening DIN 3861.

FINISHED ELEMENTS METHOD

The design in the field of mechanical engineering and construction is becoming more and more sophisticated, requiring for the related calculations to be made by using more advanced tools.

The “Finished elements method” is one of the numeric techniques used to solve the problems of structural calculation, quickly providing an idea of the strain and deformation distribution of the element.

The main concept underlying this methodology is to subdivide the model subject to analysis into triangles and therefore approximate the solution by using polynomial interpolation.

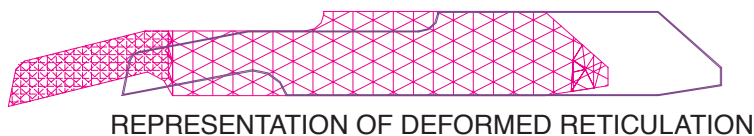

Deformation
Max X:2.0500mm
Max Y:-0.480mm



CUTTING RING "B3"

Type: 1001..

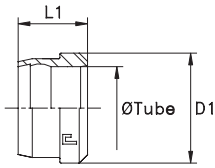

CUTTING RING "B4"

Type: 1001...4

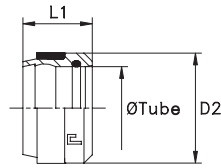

Series DIN	10.... [bar]	11.... [bar]	Ordering B3 Ring	Ø Tube	L1	D1	D2	Ordering B4 Ring			
LL	100	100	100101	4	6	6	-	-			
			100102	6	7	8	-	-			
			100103	8	7	10	-	-			
L	500	315	100104	6	9.5	10	10	100104.4			
			100105	8	9.5	12	12	100105.4			
			100106	10	10	14	14	100106.4			
			100107	12	10	16	16	100107.4			
			100108	15	10	19	20	100108.4			
			100109	18	10	23	23	100109.4			
	400	160	100110	22	10.5	27	27	100110.4			
			100111	28	11	33	33	100111.4			
			100112	35	13	41	41	100112.4			
			100113	42	13	48	48	100113.4			
			S	800	630	100104	6	9.5	10	10	100114.4
						100105	8	9.5	12	12	100115.4
100106	10	10				14	14	100116.4			
630	400	100107		12	10	16	16	100117.4			
		100118		14	10	19	19	100118.4			
		100119		16	10.5	21	21	100119.4			
420	315	100120		20	12	26	26	100120.4			
		100121		25	12	32	32	100121.4			
		100122		30	13	36	38	100122.4			
			100123	38	13	48	48	100123.4			

Note: If you wish to order a fitting in stainless steel, please change the first two digit from 10.... to 11....

TIGHTNING NUT

Type: 1002..

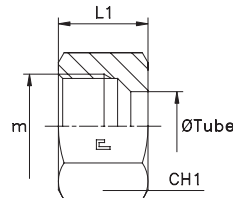

Series DIN	10.... [bar]	11.... [bar]	Ordering Nut	Ø Tube	m	L1	CH1			
LL	100	100	100201	4	8x1	11	10			
			100202	6	10x1	11.5	12			
			100203	8	12x1	12	14			
L	500	315	100204	6	12x1.5	14.5	14			
			100205	8	14x1.5	14.5	17			
			100206	10	16x1.5	15.5	19			
			100207	12	18x1.5	15.5	22			
			100208	15	22x1.5	17	27			
			100209	18	26x1.5	18	32			
	400	160	100210	22	30x2	20	36			
			100211	28	36x2	21	41			
			100212	35	45x2	24	50			
			100213	42	52x2	24	60			
			S	800	630	100214	6	14x1.5	16.5	17
						100215	8	16x1.5	16.5	19
100216	10	18x1.5				17.5	22			
630	400	100217		12	20x1.5	17.5	24			
		100218		14	22x1.5	20.5	27			
		100219		16	24x1.5	20.5	30			
420	315	100220		20	30x2	24	36			
		100221		25	36x2	27	46			
		100222		30	42x2	29	50			
			100223	38	52x2	32.5	60			

Note: If you wish to order AISI 316 stainless steel fittings, please change the first two digits from 10.... to 11....
If you wish to order AISI 304 stainless steel fittings, please change the first two digits from 10.... to 14....

MALE STUD COUPLING

Thread BSP Parallel

Type: **1003...1** Body

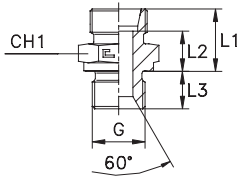

Type: **1003.. B3** Ring

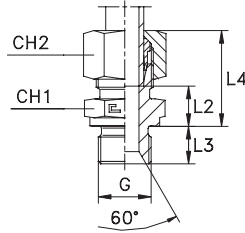

Type: **1003...4** B4 Ring

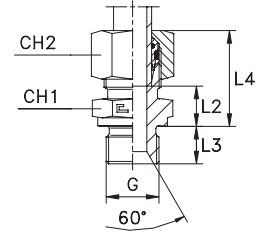

Series DIN	10.... [bar]	11.... [bar]	Ordering Body	Ordering Equipped B3	Ø Tube	G	L1	L2	L3	L4	CH1	CH2	Ordering Equipped B4
L	315	315	100304.1	100304	6	1/8	15,5	8,5	8	23	14	14	100304.4
			100305.1	100305	8	1/4	17	10	12	25	19	17	100305.4
			100306.1	100306	10	1/4	18	11	12	26	19	19	100306.4
			100307.1	100307	12	3/8	19,5	12,5	12	27	22	22	100307.4
			100308.1	100308	15	1/2	21	14	14	29	27	27	100308.4
	100309.1	100309	18	1/2	22	14,5	14	31	27	32	100309.4		
	160	160	100310.1	100310	22	3/4	24	16,5	16	33	32	36	100310.4
			100311.1	100311	28	1	25	17,5	18	34	41	41	100311.4
			100312.1	100312	35	1 1/4	28	17,5	20	39	50	50	100312.4
			100313.1	100313	42	1 1/2	30	19	22	42	55	60	100313.4
100314.1			100314	6	1/4	20	13	12	28	19	17	100314.4	
S	630	630	100315.1	100315	8	1/4	22	15	12	30	19	19	100315.4
			100316.1	100316	10	3/8	22,5	15	12	31	22	22	100316.4
			100317.1	100317	12	3/8	24,5	17	12	33	22	24	100317.4
			100318.1	100318	14	1/2	27	19	14	37	27	27	100318.4
			100319.1	100319	16	1/2	27	18,5	14	37	27	30	100319.4
	400	400	100320.1	100320	20	3/4	31	20,5	16	42	32	36	100320.4
			100321.1	100321	25	1	35	23	18	47	41	46	100321.4
			100322.1	100322	30	1 1/4	37	23,5	20	50	50	50	100322.4
			100323.1	100323	38	1 1/2	42	26	22	57	55	60	100323.4
			100324.1*	100324*	6	1/4	17	10	12	24,5	19	14	100324.4*
L	315	315	100325.1*	100325*	8	1/8	16,5	9,5	8	24,5	14	17	100325.4*
			100326.1*	100326*	8	3/8	18,5	11,5	12	26,5	22	17	100326.4*
			100327.1*	100327*	8	1/2	19	12	14	27	27	17	100327.4*
			100328.1*	100328*	10	1/8	17,5	10,5	8	25,5	17	19	100328.4*
			100329.1*	100329*	10	3/8	19,5	12,5	12	27,5	22	19	100329.4*
			100330.1*	100330*	10	1/2	20	13	14	28	27	19	100330.4*
			100331.1*	100331*	12	1/4	19	12	12	26,5	19	22	100331.4*
			100332.1*	100332*	12	1/2	20	13	14	27,5	27	22	100332.4*
			100333.1*	100333*	15	3/8	20,5	13,5	12	28,5	24	27	100333.4*
			100334.1*	100334*	18	3/4	22	14,5	16	31	32	32	100334.4*
S	630	630	100335.1*	100335*	12	1/2	25	17,5	14	33,5	27	24	100335.4*
			100336.1*	100336*	14	3/8	26,5	18,5	12	36,5	24	27	100336.4*
	400	400	100337.1*	100337*	16	3/8	26,5	18	12	36,5	27	30	100337.4*
			100338.1*	100338*	20	1/2	31	20,5	14	42	32	36	100338.4*
			100339.1*	100339*	25	3/4	35	23	16	47	41	46	100339.4*
	630	630	100340.1*	100340*	30	1	37	23,5	18	50	46	50	100340.4*
			100341.1*	100341*	8	3/8	22,5	15,5	12	30,5	22	19	100341.4*
			100342.1*	100342*	10	1/4	22	14,5	12	30,5	19	22	100342.4*
			100343.1*	100343*	10	1/2	25	17,5	14	33,5	27	22	100343.4*
	400	400	100344.1*	100344*	12	1/4	24	16,5	12	32,5	22	24	100344.4*
100345.1*			100345*	16	3/4	29	20,5	16	39	32	30	100345.4*	
L	315	315	100346.1*	100346*	20	1	33	22,5	18	44	41	36	100346.4*
			100347.1*	100347*	38	1 1/4	42	26	20	57	55	60	100347.4*
	160	160	100348.1*	100348*	15	3/4	22	15	16	30	32	27	100348.4*
			100349.1*	100349*	22	1/2	24	16,5	14	33	32	36	100349.4*
			100350.1*	100350*	22	1	25	17,5	18	34	41	36	100350.4*
			100351.1*	100351*	28	3/4	25	17,5	16	34	41	41	100351.4*
			100352.1*	100352*	35	1	28	17,5	18	39	46	50	100352.4*
			100353.1*	100353*	6	3/8	18,5	11,5	12	26	22	14	100353.4*
			100354.1*	100354*	42	1 1/4	30	19	20	42	55	60	100354.4*

Note: If you wish to order AISI 316 stainless steel fittings, please change the first two digits from **10....** to **11....** .
 If you wish to order AISI 316 stainless steel fittings with AISI 304 stainless steel nuts, please change the first two digits from **10....** to **14....** .
 * Items available on request only.

MALE STUD COUPLING

Thread Metric Parallel

Type: **1004...1** Body

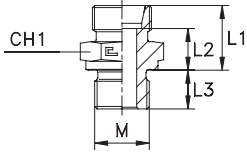

Type: **1004... B3** Ring

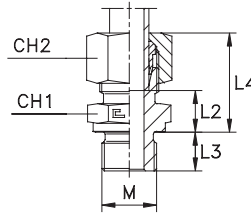

Type: **1004...4** B4 Ring

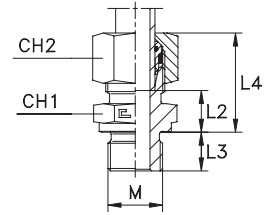

Series DIN	10.... [bar]	11.... [bar]	Ordering Body	Ordering Equipped B3	Ø Tube	M	L1	L2	L3	L4	CH1	CH2	Ordering Equipped B4
L	315	315	100404.1	100404	6	10x1	15,5	8,5	8	23	14	14	100404.4
			100405.1	100405	8	12x1,5	17	10	12	25	17	17	100405.4
			100406.1	100406	10	14x1,5	18	11	12	26	19	19	100406.4
			100407.1	100407	12	16x1,5	19,5	12,5	12	27	22	22	100407.4
			100408.1	100408	15	18x1,5	20,5	13,5	12	29	24	27	100408.4
	100409.1	100409	18	22x1,5	22	14,5	14	31	27	32	100409.4		
	160	160	100410.1	100410	22	26x1,5	24	16,5	16	33	32	36	100410.4
			100411.1	100411	28	33x2	25	17,5	18	34	41	41	100411.4
			100412.1	100412	35	42x2	28	17,5	20	39	50	50	100412.4
			100413.1	100413	42	48x2	30	19	22	42	55	60	100413.4
100414.1			100414	6	12x1,5	20	13	12	28	17	17	100414.4	
S	630	630	100415.1	100415	8	14x1,5	22	15	12	30	19	19	100415.4
			100416.1	100416	10	16x1,5	22,5	15	12	31	22	22	100416.4
			100417.1	100417	12	18x1,5	24,5	17	12	33	24	24	100417.4
			100418.1	100418	14	20x1,5	27	19	14	37	27	27	100418.4
			100419.1	100419	16	22x1,5	27	18,5	14	37	27	30	100419.4
	400	400	100420.1	100420	20	27x2	31	20,5	16	42	32	36	100420.4
			100421.1	100421	25	33x2	35	23	18	47	41	46	100421.4
			100422.1	100422	30	42x2	37	23,5	20	50	50	50	100422.4
	315	315	100423.1	100423	38	48x2	42	26	22	57	55	60	100423.4
	L	315	315	100425.1*	100425*	8	18x1,5	18,5	11,5	12	26,5	24	17
100426.1*				100426*	10	16x1,5	19,5	12,5	12	27,5	22	19	100426.4*
100427.1*				100427*	10	18x1,5	19,5	12,5	12	27,5	24	19	100427.4*
100428.1*				100428*	10	22x1,5	21	14	14	29	27	19	100428.4*
100429.1*				100429*	12	14x1,5	19,5	12,5	12	27	19	22	100429.4*
100430.1*				100430*	12	18x1,5	19,5	12,5	12	27	24	22	100430.4*
100431.1*				100431*	12	22x1,5	21	14	14	28,5	27	22	100431.4*
100432.1*				100432*	15	16x1,5	20	13	12	28	24	27	100432.4*
100433.1*				100433*	15	22x1,5	22	15	14	30	27	27	100433.4*
100434.1*				100434*	18	18x1,5	21,5	14	12	30,5	27	32	100434.4*
160	160	100435.1*	100435*	22	22x1,5	24	16,5	14	33	32	36	100435.4*	
630	630	100436.1*	100436*	12	22x1,5	25	17,5	14	33,5	27	24	100436.4*	
S	400	400	100437.1*	100437*	16	18x1,5	26,5	18	12	36,5	27	30	100437.4*
			100438.1*	100438*	20	22x1,5	31	20,5	14	42	32	36	100438.4*
			100439.1*	100439*	25	27x2	35	23	16	47	41	46	100439.4*
			100440.1*	100440*	30	33x2	37	23,5	18	50	46	50	100440.4*

Note: If you wish to order AISI 316 stainless steel fittings, please change the first two digits from **10....** to **11....** .
 If you wish to order AISI 316 stainless steel fittings with AISI 304 stainless steel nuts, please change the first two digits from **10....** to **14....** .
 * Items available on request only.

MALE STUD COUPLING WITH ELASTOMER SEAL

Thread BSP Parallel

Type: **1005...1** Body

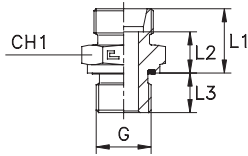

Type: **1005.. B3** Ring

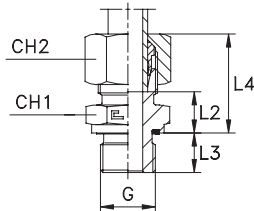

Type: **1005...4** B4 Ring

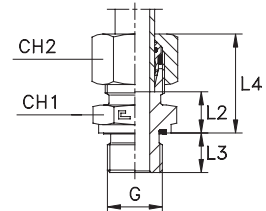

Series DIN	10.... [bar]	11.... [bar]	Ordering Body	Ordering Equipped B3	Ø Tube	G	L1	L2	L3	L4	CH1	CH2	Ordering Equipped B4
LL	100	100	100501.1	100501	4	1/8	13,5	9,5	8	20	14	10	-
			100502.1	100502	6	1/8	13,5	8	8	20	14	12	-
			100503.1	100503	8	1/8	14,5	9	8	21	14	14	-
L	500	315	100504.1	100504	6	1/8	15,5	8,5	8	23	14	14	100504.4
			100505.1	100505	8	1/4	17	10	12	25	19	17	100505.4
			100506.1	100506	10	1/4	18	11	12	26	19	19	100506.4
			100507.1	100507	12	3/8	19,5	12,5	12	27	22	22	100507.4
			100508.1	100508	15	1/2	21	14	14	29	27	27	100508.4
	400	160	100509.1	100509	18	1/2	22	14,5	14	31	27	32	100509.4
			100510.1	100510	22	3/4	24	16,5	16	33	32	36	100510.4
			100511.1	100511	28	1	25	17,5	18	34	41	41	100511.4
			100512.1	100512	35	1 1/4	28	17,5	20	39	50	50	100512.4
			100513.1	100513	42	1 1/2	30	19	22	42	55	60	100513.4
S	800	630	100514.1	100514	6	1/4	20	13	12	28	19	17	100514.4
			100515.1	100515	8	1/4	22	15	12	30	19	19	100515.4
			100516.1	100516	10	3/8	22,5	15	12	31	22	22	100516.4
	630	400	100517.1	100517	12	3/8	24,5	17	12	33	22	24	100517.4
			100518.1	100518	14	1/2	27	19	14	37	27	27	100518.4
			100519.1	100519	16	1/2	27	18,5	14	37	27	30	100519.4
	420	315	100520.1	100520	20	3/4	31	20,5	16	42	32	36	100520.4
			100521.1	100521	25	1	35	23	18	47	41	46	100521.4
			100522.1	100522	30	1 1/4	37	23,5	20	50	50	50	100522.4
			100523.1	100523	38	1 1/2	42	26	22	57	55	60	100523.4
L	500	315	100524.1	100524	6	1/4	17	10	12	24,5	19	14	100524.4
			100525.1	100525	8	1/8	16,5	9,5	8	24,5	14	17	100525.4
			100526.1	100526	8	3/8	18,5	11,5	12	26,5	22	17	100526.4
	400	315	100527.1	100527	8	1/2	19	12	14	27	27	17	100527.4
			100528.1	100528	10	1/8	17,5	10,5	8	25,5	17	19	100528.4
			100529.1	100529	10	3/8	19,5	12,5	12	27,5	22	19	100529.4
			100530.1	100530	10	1/2	20	13	14	28	27	19	100530.4
			100531.1	100531	12	1/4	19	12	12	26,5	19	22	100531.4
			100532.1	100532	12	1/2	20	13	14	27,5	27	22	100532.4
			100533.1	100533	15	3/8	20,5	13,5	12	28,5	24	27	100533.4
250	315	100534.1	100534	18	3/4	22	14,5	16	31	32	32	100534.4	
100535.1		100535	12	1/2	25	17,5	14	33,5	27	24	100535.4		
S	630	630	100536.1	100536	14	3/8	26,5	18,5	12	36,5	24	27	100536.4
			100537.1	100537	16	3/8	26,5	18	12	36,5	27	30	100537.4
			100538.1	100538	20	1/2	31	20,5	14	42	32	36	100538.4
	420	400	100539.1	100539	25	3/4	35	23	16	47	41	46	100539.4
			100540.1	100540	30	1	37	23,5	18	50	46	50	100540.4
			100541.1	100541	8	3/8	22,5	15,5	12	30,5	22	19	100541.4
	800	630	100542.1	100542	10	1/4	22	14,5	12	30,5	19	22	100542.4
			100543.1	100543	10	1/2	25	17,5	14	33,5	27	22	100543.4
			100544.1	100544	12	1/4	24	16,5	12	32,5	22	24	100544.4
			100545.1	100545	16	3/4	29	20,5	16	39	32	30	100545.4
630	400	100546.1	100546	20	1	33	22,5	18	44	41	36	100546.4	
		100547.1	100547	38	1 1/4	42	26	20	57	55	60	100547.4	
		100548.1	100548	15	3/4	22	15	16	30	32	27	100548.4	
L	250	160	100549.1	100549	22	1/2	24	16,5	14	33	32	36	100549.4
			100550.1	100550	22	1	25	17,5	18	34	41	36	100550.4
			100551.1	100551	28	3/4	25	17,5	16	34	41	41	100551.4
			100552.1	100552	35	1	28	17,5	18	39	46	50	100552.4
			100553.1	100553	6	3/8	18,5	11,5	12	26	22	14	100553.4
400	315	160	100554.1	100554	42	1 1/4	30	19	20	42	55	60	100554.4

Note: If you wish to order AISI 316 stainless steel fittings, please change the first two digits from **10....** to **11....** .
 If you wish to order AISI 316 stainless steel fittings with AISI 304 stainless steel nuts, please change the first two digits from **10....** to **14....** .

MALE STUD COUPLING WITH ELASTOMER SEAL

Thread Metric Parallel

Type: **1006...1** Body

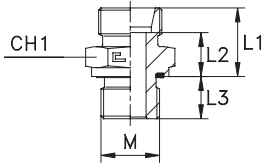

Type: **1006... B3** Ring

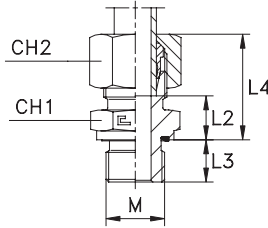

Type: **1006...4** B4 Ring

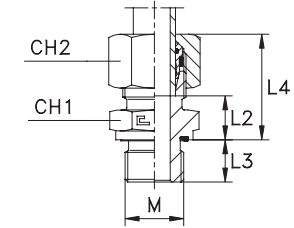

Series DIN	10.... [bar]	11.... [bar]	Ordering Body	Ordering Equipped B3	Ø Tube	M	L1	L2	L3	L4	CH1	CH2	Ordering Equipped B4
LL	100	100	100601.1	100601	4	8x1	13,5	9,5	8	20	12	10	-
			100602.1	100602	6	10x1	13,5	8	8	20	14	12	-
			100603.1	100603	8	10x1	14,5	9	8	21	14	14	-
L	500	315	100604.1	100604	6	10x1	15,5	8,5	8	23	14	14	100604.4
			100605.1	100605	8	12x1,5	17	10	12	25	17	17	100605.4
			100606.1	100606	10	14x1,5	18	11	12	26	19	19	100606.4
	100607.1		100607	12	16x1,5	19,5	12,5	12	27	22	22	100607.4	
	100608.1		100608	15	18x1,5	20,5	13,5	12	29	24	27	100608.4	
	100609.1		100609	18	22x1,5	22	14,5	14	31	27	32	100609.4	
	250	160	100610.1	100610	22	26x1,5	24	16,5	16	33	32	36	100610.4
			100611.1	100611	28	33x2	25	17,5	18	34	41	41	100611.4
			100612.1	100612	35	42x2	28	17,5	20	39	50	50	100612.4
100613.1	100613	42	48x2	30	19	22	42	55	60	100613.4			
S	800	630	100614.1	100614	6	12x1,5	20	13	12	28	17	17	100614.4
			100615.1	100615	8	14x1,5	22	15	12	30	19	19	100615.4
			100616.1	100616	10	16x1,5	22,5	15	12	31	22	22	100616.4
	630	400	100617.1	100617	12	18x1,5	24,5	17	12	33	24	24	100617.4
			100618.1	100618	14	20x1,5	27	19	14	37	27	27	100618.4
			100619.1	100619	16	22x1,5	27	18,5	14	37	27	30	100619.4
	420	315	100620.1	100620	20	27x2	31	20,5	16	42	32	36	100620.4
			100621.1	100621	25	33x2	35	23	18	47	41	46	100621.4
			100622.1	100622	30	42x2	37	23,5	20	50	50	50	100622.4
100623.1	100623	38	48x2	42	26	22	57	55	60	100623.4			
L	400	315	100625.1	100625	8	18x1,5	18,5	11,5	12	26,5	24	17	100625.4
			100626.1	100626	10	16x1,5	19,5	12,5	12	27,5	22	19	100626.4
			100627.1	100627	10	18x1,5	19,5	12,5	12	27,5	24	19	100627.4
			100628.1	100628	10	22x1,5	21	14	14	29	27	19	100628.4
			100629.1	100629	12	14x1,5	19,5	12,5	12	27	19	22	100629.4
			100630.1	100630	12	18x1,5	19,5	12,5	12	27	24	22	100630.4
			100631.1	100631	12	22x1,5	21	14	14	28,5	27	22	100631.4
			100632.1	100632	15	16x1,5	20	13	12	28	24	27	100632.4
			100633.1	100633	15	22x1,5	22	15	14	30	27	27	100633.4
			100634.1	100634	18	18x1,5	21,5	14	12	30,5	27	32	100634.4
			100635.1	100635	22	22x1,5	24	16,5	14	33	32	36	100635.4
			S	630	630	100636.1	100636	12	22x1,5	25	17,5	14	33,5
100637.1	100637	16				18x1,5	26,5	18	12	36,5	27	30	100637.4
420	400	100638.1		100638	20	22x1,5	31	20,5	14	42	32	36	100638.4
		100639.1		100639	25	27x2	35	23	16	47	41	46	100639.4
		100640.1		100640	30	33x2	37	23,5	18	50	46	50	100640.4
L	500	315	100641.1	100641	8	10x1	16,5	8,5	8	24,5	14	17	100641.4

Note: If you wish to order AISI 316 stainless steel fittings, please change the first two digits from **10....** to **11....** .
If you wish to order AISI 316 stainless steel fittings with AISI 304 stainless steel nuts, please change the first two digits from **10....** to **14....** .

FEMALE STUD COUPLING

Thread BSP Parallel - Thread Metric Parallel

Type: **1007...1** Body
Type: **1008...1** Body

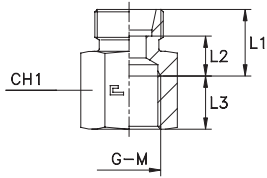

Type: **1007.. B3** Ring
Type: **1008.. B3** Ring

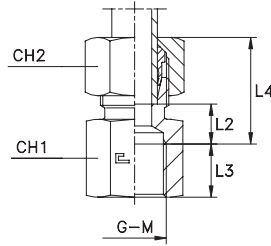

Type: **1007...4 B4** Ring
Type: **1008...4 B4** Ring

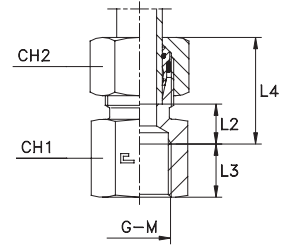

Series DIN	10.... [bar]	11.... [bar]	Ordering Body	Ordering Equipped B3	Ø Tube	G	L1	L2	L3	L4	CH1	CH2	Ordering Equipped B4
L	315	315	100704.1	100704	6	1/8	16	9	10	23,5	14	14	100704.4
			100705.1	100705	8	1/4	17	10	14	25	19	17	100705.4
			100706.1	100706	10	1/4	18	11	14	26	19	19	100706.4
			100707.1	100707	12	3/8	19	12	14	26,5	24	22	100707.4
			100708.1	100708	15	1/2	21	14	17	29	27	27	100708.4
	100709.1	100709	18	1/2	21	13,5	17	30	27	32	100709.4		
	160	160	100710.1	100710	22	3/4	24	16,5	19	33	36	36	100710.4
			100711.1	100711	28	1	23,5	16	21,5	32,5	41	41	100711.4
			100712.1	100712	35	1 1/4	28,5	18	23,5	39,5	55	50	100712.4
			100713.1	100713	42	1 1/2	28,5	17,5	25,5	40,5	60	60	100713.4
100714.1			100714	6	1/4	19	12	14	27	19	17	100714.4	
S	400	400	100715.1	100715	8	1/4	19	12	14	27	19	19	100715.4
			100716.1	100716	10	3/8	20	12,5	14	28,5	24	22	100716.4
			100717.1	100717	12	3/8	20	12,5	14	28,5	24	24	100717.4
			100718.1	100718	14	1/2	23	15	17	33	30	27	100718.4
			100719.1	100719	16	1/2	23	14,5	17	33	30	30	100719.4
	315	315	100720.1	100720	20	3/4	26	15,5	19	37	36	36	100720.4
			100721.1	100721	25	1	27,5	15,5	21,5	39,5	41	46	100721.4
			100722.1	100722	30	1 1/4	32,5	19	23,5	45,5	55	50	100722.4
			100723.1	100723	38	1 1/2	34,5	18,5	25,5	49,5	60	60	100723.4
			250	250	100723.1	100723	38	1 1/2	34,5	18,5	25,5	49,5	60

Note: If you wish to order AISI 316 stainless steel fittings, please change the first two digits from **10....** to **11....** .
If you wish to order AISI 316 stainless steel fittings with AISI 304 stainless steel nuts, please change the first two digits from **10....** to **14....** .

Series DIN	10.... [bar]	11.... [bar]	Ordering Body	Ordering Equipped B3	Ø Tube	M	L1	L2	L3	L4	CH1	CH2	Ordering Equipped B4
L	315	315	100804.1	100804	6	10x1	16	9	10	23,5	14	14	100804.4
			100805.1	100805	8	12x1,5	16,5	9,5	14,5	24,5	17	17	100805.4
			100806.1	100806	10	14x1,5	17,5	10,5	14,5	25,5	19	19	100806.4
			100807.1	100807	12	16x1,5	18,5	11,5	14,5	26	22	22	100807.4
			100808.1	100808	15	18x1,5	23,5	16,5	14,5	31,5	24	27	100808.4
	100809.1	100809	18	22x1,5	21,5	14	16,5	30,5	30	32	100809.4		
	160	160	100810.1	100810	22	26x1,5	23,5	16	18,5	32,5	32	36	100810.4
			100811.1	100811	28	33x2	24	16,5	21	33	41	41	100811.4
			100812.1	100812	35	42x2	28	17,5	23	39	55	50	100812.4
			100813.1	100813	42	48x2	29	18	25	41	60	60	100813.4
100814.1			100814	6	12x1,5	18,5	11,5	14,5	26,5	17	17	100814.4	
S	400	400	100815.1	100815	8	14x1,5	18,5	11,5	14,5	26,5	19	19	100815.4
			100816.1	100816	10	16x1,5	19,5	12	14,5	28	22	22	100816.4
			100817.1	100817	12	18x1,5	19,5	12	14,5	28	24	24	100817.4
			100818.1	100818	14	20x1,5	23,5	15,5	16,5	33,5	27	27	100818.4
			100819.1	100819	16	22x1,5	23,5	15	16,5	33,5	30	30	100819.4
	315	315	100820.1	100820	20	27x2	26	15,5	19	37	36	36	100820.4
			100821.1	100821	25	33x2	28	16	21	40	41	46	100821.4
			100822.1	100822	30	42x2	33	19,5	23	46	55	50	100822.4
			100823.1	100823	38	48x2	35	19	25	50	60	60	100823.4
			250	250	100823.1	100823	38	48x2	35	19	25	50	60

Note: If you wish to order AISI 316 stainless steel fittings, please change the first two digits from **10....** to **11....** .
If you wish to order AISI 316 stainless steel fittings with AISI 304 stainless steel nuts, please change the first two digits from **10....** to **14....** .
* Items available on request only.

MALE STUD COUPLING WITH O-RING

Thread UNF/UN-2A

Type: **1009...1** Body

Type: **1009.. B3** Ring

Type: **1009...4** B4 Ring

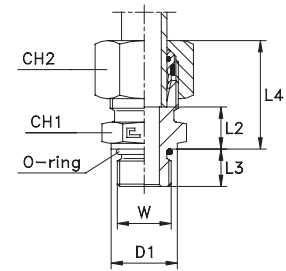
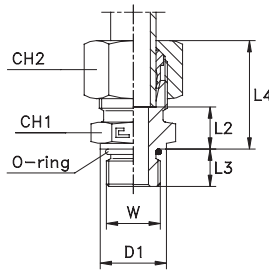
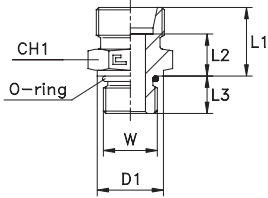

Series DIN	10.... [bar]	11.... [bar]	Ordering Body	Ordering Equipped B3	Ø Tube	W	D1	L1	L2	L3	L4	CH1	CH2	Ordering Equipped B4
L	315	315	100904.1	100904	6	7/16-20	13,8	16,9	9,9	9,1	24,5	14	14	100904.4
			100905.1	100905	8	1/2-20	16,8	16,9	9,9	9,1	25	17	17	100905.4
			100906.1	100906	10	1/2-20	16,8	17,9	10,9	9,1	26	17	19	100906.4
			100907.1	100907	12	9/16-18	18,8	18	11	10	25,5	19	22	100907.4
			100908.1	100908	15	3/4-16	21,8	20,9	13,9	11,1	29	24	27	100908.4
	100909.1	100909	18	3/4-16	21,8	21,9	14,4	11,1	31	27	32	100909.4		
	160	160	100910.1	100910	22	1 1/16-12	31,8	23,9	16,4	15,1	33	32	36	100910.4
			100911.1	100911	28	15/16-12	40,8	24,9	17,4	15,1	34	41	41	100911.4
			100912.1	100912	35	15/8-12	49,8	27,9	17,4	15,1	39	50	50	100912.4
			100913.1	100913	42	1 7/8-12	54,8	29,9	18,9	15,1	42	55	60	100913.4
100914.1			100914	6	1/2-20	16,8	21,9	14,9	9,1	30	17	17	100914.4	
S	630	630	100915.1	100915	8	1/2-20	16,8	21,9	14,9	9,1	30	17	19	100915.4
			100916.1	100916	10	9/16-18	18,8	22	14,5	10	30,5	19	22	100916.4
			100917.1	100917	12	9/16-18	18,8	22	14,5	10	30,5	22	24	100917.4
			100918.1	100918	14	3/4-16	21,8	23,9	15,9	11,1	34	24	27	100918.4
	400	400	100919.1	100919	16	3/4-16	21,8	23,9	15,4	11,1	34	27	30	100919.4
			100920.1	100920	20	11/16-12	31,8	30,9	20,4	15,1	42	32	36	100920.4
			100921.1	100921	25	15/16-12	40,8	34,9	22,9	15,1	47	41	46	100921.4
	315	315	100922.1	100922	30	15/8-12	49,8	36,9	23,4	15,1	50	50	50	100922.4
			100923.1	100923	38	1 7/8-12	54,8	41,9	25,9	15,1	57	55	60	100923.4
			100924.1	100924	8	7/16-20	13,8	16,9	9,9	9,1	25	14	17	100924.4
L	315	315	100925.1	100925	10	7/16-20	13,8	17,9	10,9	9,1	26	17	19	100925.4
			100926.1	100926	12	3/4-16	21,8	19,9	12,9	11,1	27,5	22	22	100926.4
			100927.1	100927	12	7/8-14	26,8	21,3	14,3	12,7	29	27	22	100927.4
			100928.1	100928	18	7/8-14	26,8	22,3	14,8	12,7	31,5	27	32	100928.4
	160	160	100929.1	100929	22	7/8-14	26,8	24,3	16,8	12,7	33,5	32	36	100929.4
			100930.1	100930	22	15/16-12	40,8	24,9	17,4	15,1	34	41	36	100930.4
			100931.1	100931	28	1 1/16-12	31,8	24,9	17,4	15,1	34	41	41	100931.4
			100932.1	100932	35	15/16-12	40,8	27,9	17,4	15,1	39	46	50	100932.4
			100933.1	100933	42	15/8-12	49,8	29,9	18,9	15,1	42	55	60	100933.4
			100934.1	100934	8	7/16-20	13,8	21,9	14,9	9,1	30	17	19	100934.4
S	630	630	100935.1	100935	12	3/4-16	21,8	24,9	17,4	11,1	33,5	22	24	100935.4
			100936.1	100936	16	7/8-14	26,8	27,3	18,8	12,7	37,5	27	30	100936.4
	400	400	100937.1	100937	20	3/4-16	21,8	30,9	20,4	11,1	42	32	36	100937.4
			100938.1	100938	20	7/8-14	26,8	31,3	20,8	12,7	42,5	32	36	100938.4
			100939.1	100939	25	1 1/16-12	31,8	34,9	22,9	15,1	47	36	46	100939.4
			100940.1	100940	30	15/16-12	40,8	36,9	23,4	15,1	50	46	50	100940.4
			100941.1	100941	38	15/8-12	49,8	41,9	25,9	15,1	57	55	60	100941.4

Note: If you wish to order AISI 316 stainless steel fittings, please change the first two digits from **10....** to **11....** .
 If you wish to order AISI 316 stainless steel fittings with AISI 304 stainless steel nuts, please change the first two digits from **10....** to **14....** .
 * Items available on scheduled orders only.

BANJO COUPLING WITH Thread BSP Parallel

Type: **1013...1** Body

Type: **1013..** B3 Ring

Type: **1013...4** B4 Ring

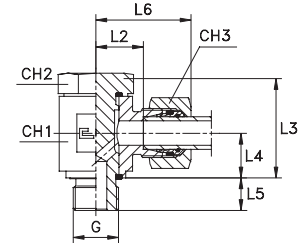
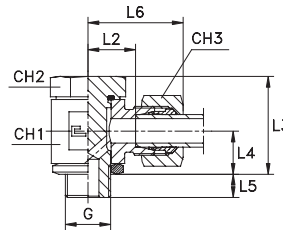
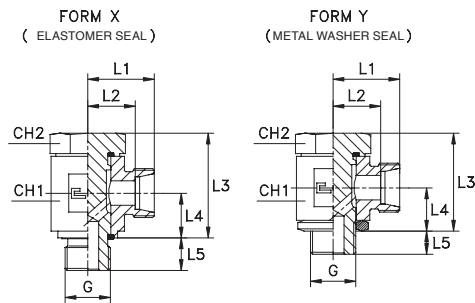

Series DIN	10.... [bar]	11.... [bar]	Ordering Body	Ordering Equipped B3	Ø Tube	G	FORM	L1	L2	L3	L4	L5	L6	CH1	CH2	CH3	Ordering Equipped B4
LL	100	100	101301.1	101301	4	1/8	X	18	14	24	10,5	8	24	17	17	10	-
			101302.1	101302	6	1/8	X	18	12,5	24	10,5	8	24	17	17	12	-
			101303.1	101303	8	1/8	X	19	13,5	24	10,5	8	25	17	17	14	-
L	315	315	101304.1	101304	6	1/8	X	19	12	24	10,5	8	27	17	17	14	101304.4
			101305.1	101305	8	1/4	X	21,5	14,5	32	14	12	29,5	22	19	17	101305.4
			101306.1	101306	10	1/4	X	22,5	15,5	32	14	12	30,5	22	19	19	101306.4
			101307.1	101307	12	3/8	X	25	18	38,5	16,5	12	33	27	24	22	101307.4
			101308.1	101308	15	1/2	X	29	22	46,5	21,5	14	37	32	30	27	101308.4
			101309.1	101309	18	1/2	X	29	21,5	46,5	21,5	14	38	32	30	32	101309.4
	160	160	101310.1	101310	22	3/4	X	34	26,5	54	24	16	43	41	36	36	101310.4
			101311.1	101311	28	1	X	38,5	31	66,5	30,5	18	47,5	50	46	41	101311.4
			101312.1	101312	35	1 1/4	X	45,5	35	80	35,5	20	56,5	60	55	50	101312.4
			101313.1	101313	42	1 1/2	X	50,5	39,5	90	40,5	22	62,5	70	60	60	101313.4
S	400	400	101314.1	101314	6	1/4	X	23,5	16,5	32	14	12	31,5	22	19	17	101314.4
			101315.1	101315	8	1/4	X	23,5	16,5	32	14	12	31,5	22	19	19	101315.4
			101316.1	101316	10	3/8	X	26	18,5	38,5	16,5	12	35	27	24	22	101316.4
			101317.1	101317	12	3/8	X	26	18,5	38,5	16,5	12	35	27	24	24	101317.4
	315	315	101318.1	101318	14	1/2	X	31	23	46,5	21,5	14	41	32	30	27	101318.4
			101319.1	101319	16	1/2	X	31	22,5	46,5	21,5	14	41	32	30	30	101319.4
	250	250	101320.1	101320	20	3/4	X	36	25,5	54	24	16	47	41	36	36	101320.4
			101321.1	101321	25	1	X	42,5	30,5	66,5	30,5	18	54,5	50	46	46	101321.4
	200	200	101322.1	101322	30	1 1/4	X	49,5	36	80	35,5	20	62,5	60	55	50	101322.4
			101323.1	101323	38	1 1/2	X	56,5	40,5	90	40,5	22	71,5	70	60	60	101323.4
LL	100	100	101351.1	101351	4	1/8	Y	17,5	13,5	21,5	10	6	23,5	14	14	10	-
			101352.1	101352	6	1/8	Y	17,5	12	21,5	10	6	23,5	14	14	12	-
			101353.1	101353	8	1/8	Y	18,5	13	21,5	10	6	24,5	14	14	14	-
L	250	250	101354.1	101354	6	1/8	Y	18,5	11,5	21,5	10	6	26,5	14	14	14	101354.4
			101355.1	101355	8	1/4	Y	21	14	27,5	13	9	29	19	19	17	101355.4
			101356.1	101356	10	1/4	Y	22	15	27,5	13	9	30	19	19	19	101356.4
			101357.1	101357	12	3/8	Y	24	17	32,5	15	9	32	22	22	22	101357.4
	160	160	101358.1	101358	15	1/2	Y	27	20	45	21,5	10	35	30	27	27	101358.4
			101359.1	101359	18	1/2	Y	27	19,5	45	21,5	10	36	30	27	32	101359.4
S	250	250	101360.1	101360	22	3/4	Y	33	25,5	48	23	13	42	36	32	36	101360.4
			101364.1	101364	6	1/4	Y	23	16	27,5	13	9	31	19	19	17	101364.4
			101365.1	101365	8	1/4	Y	23	16	27,5	13	9	31	19	19	19	101365.4
			101366.1	101366	10	3/8	Y	25	17,5	32,5	15	9	34	22	22	22	101366.4
			101367.1	101367	12	3/8	Y	25	17,5	32,5	15	9	34	22	22	24	101367.4
			101368.1	101368	14	1/2	Y	29	21	45	21,5	10	39	30	27	27	101368.4
	160	160	101369.1	101369	16	1/2	Y	29	20,5	45	21,5	10	39	30	27	30	101369.4
			101370.1	101370	20	3/4	Y	35	24,5	48	23	13	46	36	32	36	101370.4

Note: If you wish to order AISI 316 stainless steel fittings, please change the first two digits from **10....** to **11....** .
If you wish to order AISI 316 stainless steel fittings with AISI 304 stainless steel nuts, please change the first two digits from **10....** to **14....** .
Items not included in the ISO 8434-1 Norm.

BANJO COUPLING

Thread Metric Parallel

Type: **1014...1** Body

Type: **1014.. B3** Ring

Type: **1014...4** B4 Ring

FORM X
(ELASTOMER SEAL)

FORM Y
(METAL WASHER SEAL)

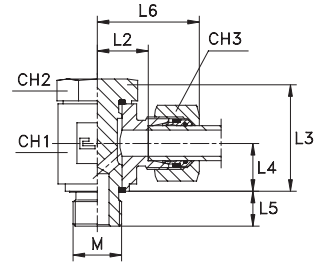
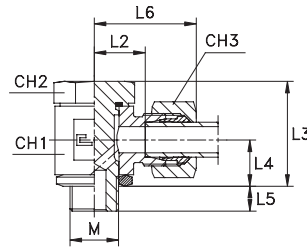
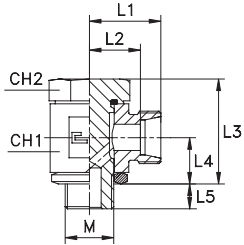
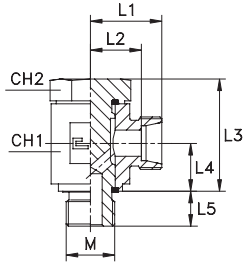

Series DIN	10.... [bar]	11.... [bar]	Ordering Body	Ordering Equipped B3	Ø Tube	M	FORM	L1	L2	L3	L4	L5	L6	CH1	CH2	CH3	Ordering Equipped B4
LL	100	100	101401.1	101401	4	8x1	X	18	14	24	10,5	8	24	17	14	10	-
			101402.1	101402	6	10x1	X	18	12,5	24	10,5	8	24	17	17	12	-
			101403.1	101403	8	10x1	X	19	13,5	24	10,5	8	25	17	17	14	-
L	315	315	101404.1	101404	6	10x1	X	19	12	24	10,5	8	27	17	17	14	101404.4
			101405.1	101405	8	12x1,5	X	21,5	14,5	32	14	12	29,5	22	19	17	101405.4
			101406.1	101406	10	14x1,5	X	22,5	15,5	32	14	12	30,5	22	19	19	101406.4
			101407.1	101407	12	16x1,5	X	25	18	38,5	16,5	12	33	27	24	22	101407.4
			101408.1	101408	15	18x1,5	X	29	22	42	18,5	12	37	32	27	27	101408.4
			101409.1	101409	18	22x1,5	X	29	21,5	46,5	21,5	14	38	32	30	32	101409.4
			101410.1	101410	22	26x1,5	X	34	26,5	54	24	16	43	41	36	36	101410.4
	160	160	101411.1	101411	28	33x2	X	38,5	31	66,5	30,5	18	47,5	50	46	41	101411.4
			101412.1	101412	35	42x2	X	45,5	35	80	35,5	20	56,5	60	55	50	101412.4
			101413.1	101413	42	48x2	X	50,5	39,5	90	40,5	22	62,5	70	60	60	101413.4
S	400	400	101414.1	101414	6	12x1,5	X	23,5	16,5	32	14	12	31,5	22	19	17	101414.4
			101415.1	101415	8	14x1,5	X	23,5	16,5	32	14	12	31,5	22	19	19	101415.4
			101416.1	101416	10	16x1,5	X	26	18,5	38,5	16,5	12	35	27	24	22	101416.4
			101417.1	101417	12	18x1,5	X	29	21,5	42	18,5	12	38	32	27	24	101417.4
	315	315	101418.1	101418	14	20x1,5	X	31	23	45	20	14	41	32	30	27	101418.4
			101419.1	101419	16	22x1,5	X	31	22,5	46,5	21,5	14	41	32	30	30	101419.4
	250	250	101420.1	101420	20	27x2	X	36	25,5	54	24	16	47	41	36	36	101420.4
			101421.1	101421	25	33x2	X	42,5	31,5	66,5	30,5	18	54,5	50	46	46	101421.4
	200	200	101422.1	101422	30	42x2	X	49,5	36	80	35,5	20	62,5	60	55	50	101422.4
			101423.1	101423	38	48x2	X	56,5	40,5	90	40,5	22	71,5	70	60	60	101423.4
LL	100	100	101451.1	101451	4	8x1	Y	17,5	13,5	21,5	10	6	23,5	14	12	10	-
			101452.1	101452	6	10x1	Y	17,5	12	21,5	10	6	23,5	14	14	12	-
			101453.1	101453	8	10x1	Y	18,5	13	21,5	10	6	24,5	14	14	14	-
L	250	250	101454.1	101454	6	10x1	Y	18,5	11,5	21,5	10	6	26,5	14	14	14	101454.4
			101455.1	101455	8	12x1,5	Y	21	14	27,5	13	9	29	19	17	17	101455.4
			101456.1	101456	10	14x1,5	Y	22	15	27,5	13	9	30	19	19	19	101456.4
			101457.1	101457	12	16x1,5	Y	24	17	32,5	15	9	32	22	22	22	101457.4
			101458.1	101458	15	18x1,5	Y	25	18	37	17	9	33	24	24	27	101458.4
	160	160	101459.1	101459	18	22x1,5	Y	27	19,5	45	21,5	10	36	30	27	32	101459.4
			101460.1	101460	22	26x1,5	Y	33	25,5	48	23	13	42	36	32	36	101460.4
S	250	250	101464.1	101464	6	12x1,5	Y	23	16	27,5	13	9	31	19	17	17	101464.4
			101465.1	101465	8	14x1,5	Y	23	16	27,5	13	9	31	19	19	19	101465.4
			101466.1	101466	10	16x1,5	Y	25	17,5	32,5	15	9	34	22	22	22	101466.4
			101467.1	101467	12	18x1,5	Y	25	17,5	37	17	9	34	24	24	24	101467.4
			101468.1	101468	14	20x1,5	Y	28	20	45	21,5	10	38	27	27	27	101468.4
	160	160	101469.1	101469	16	22x1,5	Y	29	20,5	45	21,5	10	39	30	27	30	101469.4
			101470.1	101470	20	27x2	Y	35	24,5	48	23	13	46	36	32	36	101470.4

Note: If you wish to order AISI 316 stainless steel fittings, please change the first two digits from **10....** to **11....** .
 If you wish to order AISI 316 stainless steel fittings with AISI 304 stainless steel nuts, please change the first two digits from **10....** to **14....** .
 Items not included in the ISO 8434-1 Norm.

BANJO TEE COUPLING WITH ALLOW SCREW AND ELASTOMER SEAL

Thread BSP Parallel - Thread Metric Parallel

Type: **1015...1** Body
Type: **1016...1** Body

Type: **1015.. B3** Ring
Type: **1016.. B3** Ring

Type: **1015...4** B4 Ring
Type: **1016...4** B4 Ring

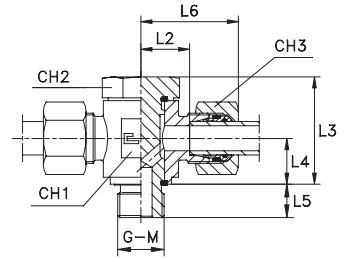
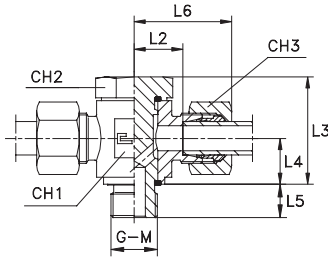
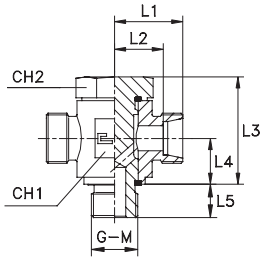

Series DIN	10.... [bar]	11.... [bar]	Ordering Body	Ordering Equipped B3	Ø Tube	G	L1	L2	L3	L4	L5	L6	CH1	CH2	CH3	Ordering Equipped B4
L	315	315	101504.1	101504	6	1/8	19	12	24	10,5	8	27	17	17	14	101504.4
			101505.1	101505	8	1/4	21,5	14,5	32	14	12	29,5	22	19	17	101505.4
			101506.1	101506	10	1/4	22,5	15,5	32	14	12	30,5	22	19	19	101506.4
			101507.1	101507	12	3/8	25	18	38,5	16,5	12	33	27	24	22	101507.4
			101508.1	101508	15	1/2	29	22	46,5	21,5	14	37	32	30	27	101508.4
	101509.1	101509	18	1/2	29	21,5	46,5	21,5	14	38	32	30	32	101509.4		
	160	160	101510.1	101510	22	3/4	34	26,5	54	24	16	43	41	36	36	101510.4
			101511.1	101511	28	1	38,5	31	66,5	30,5	18	47,5	50	46	41	101511.4
			101512.1	101512	35	1 1/4	45,5	35	80	35,5	20	56,5	60	55	50	101512.4
			101513.1	101513	42	1 1/2	50,5	39,5	90	40,5	22	62,5	70	60	60	101513.4
101514.1			101514	6	1/4	23,5	16,5	32	14	12	31,5	22	19	17	101514.4	
S	400	400	101515.1	101515	8	1/4	23,5	16,5	32	12	12	31,5	22	19	19	101515.4
			101516.1	101516	10	3/8	26	18,5	38,5	16,5	12	35	27	24	22	101516.4
			101517.1	101517	12	3/8	26	18,5	38,5	16,5	12	35	27	24	24	101517.4
			101518.1	101518	14	1/2	31	23	46,5	21,5	14	41	32	30	27	101518.4
	315	315	101519.1	101519	16	1/2	31	22,5	46,5	21,5	14	41	32	30	30	101519.4
			101520.1	101520	20	3/4	36	25,5	54	24	16	47	41	36	36	101520.4
	250	250	101521.1	101521	25	1	42,5	30,5	66,5	30,5	18	54,5	50	46	46	101521.4
			101522.1	101522	30	1 1/4	49,5	36	80	35,5	20	62,5	60	55	50	101522.4
	200	200	101523.1	101523	38	1 1/2	56,5	40,5	90	40,5	22	71,5	70	60	60	101523.4

Note: If you wish to order AISI 316 stainless steel fittings, please change the first two digits from **10....** to **11....** .
If you wish to order AISI 316 stainless steel fittings with AISI 304 stainless steel nuts, please change the first two digits from **10....** to **14....** .
Items not included in the ISO 8434-1 Norm available on scheduled orders only

Series DIN	10.... [bar]	11.... [bar]	Ordering Body	Ordering Equipped B3	Ø Tube	M	L1	L2	L3	L4	L5	L6	CH1	CH2	CH3	Ordering Equipped B4
L	315	315	101604.1	101604	6	10x1	19	12	24	10,5	8	26	17	17	14	101604.4
			101605.1	101605	8	12x1,5	21,5	14,5	32	14	12	29,5	22	19	17	101605.4
			101606.1	101606	10	14x1,5	22,5	15,5	32	14	12	30,5	22	19	19	101606.4
			101607.1	101607	12	16x1,5	25	18	38,5	16,5	12	33	27	24	22	101607.4
			101608.1	101608	15	18x1,5	29	22	42	18,5	12	37	32	27	27	101608.4
	101609.1	101609	18	22x1,5	29	21,5	46,5	21,5	14	38	32	30	32	101609.4		
	160	160	101610.1	101610	22	26x1,5	34	26,5	54	24	16	43	41	36	36	101610.4
			101611.1	101611	28	33x2	38,5	31	66,5	30,5	18	47,5	50	46	41	101611.4
			101612.1	101612	35	42x2	45,5	35	80	35,5	20	56,5	60	55	50	101612.4
			101613.1	101613	42	48x2	50,5	39,5	90	40,5	22	62,5	70	60	60	101613.4
101614.1			101614	6	12x1,5	23,5	16,5	32	14	12	31,5	22	19	17	101614.4	
S	400	400	101615.1	101615	8	14x1,5	23,5	16,5	32	14	12	31,5	22	19	19	101615.4
			101616.1	101616	10	16x1,5	26	18,5	38,5	16,5	12	35	27	24	22	101616.4
			101617.1	101617	12	18x1,5	29	21,5	42	18,5	12	38	32	27	24	101617.4
			101618.1	101618	14	20x1,5	31	23	45	20	14	41	32	30	27	101618.4
	315	315	101619.1	101619	16	22x1,5	31	22,5	46,5	21,5	14	41	32	30	30	101619.4
			101620.1	101620	20	27x2	36	25,5	54	24	16	47	41	36	36	101620.4
	250	250	101621.1	101621	25	33x2	42,5	31,5	66,5	30,5	18	54,5	50	46	46	101621.4
			101622.1	101622	30	42x2	49,5	36	80	35,5	20	62,5	60	55	50	101622.4
	200	200	101623.1	101623	38	48x2	56,5	40,5	90	40,5	22	71,5	70	60	60	101623.4

Note: If you wish to order AISI 316 stainless steel fittings, please change the first two digits from **10....** to **11....** .
If you wish to order AISI 316 stainless steel fittings with AISI 304 stainless steel nuts, please change the first two digits from **10....** to **14....** .
Items not included in the ISO 8434-1 Norm available on scheduled orders only

MALE STUD COUPLING

Thread BSP Taper

Type: **1017...1** Body

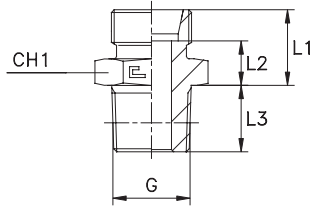

Type: **1017.. B3** Ring

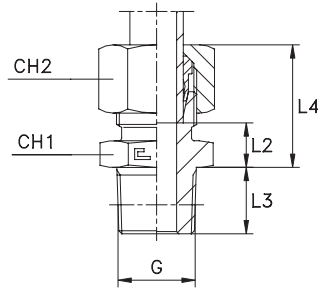

Type: **1017...4** B4 Ring

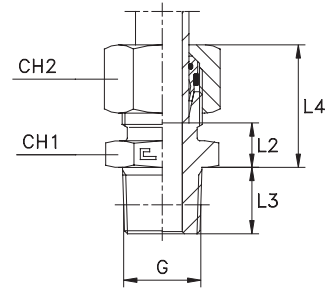

Series DIN	10.... [bar]	11.... [bar]	Ordering Body	Ordering Equipped B3	Ø Tube	G	L1	L2	L3	L4	CH1	CH2	Ordering Equipped B4
LL	100	100	101701.1	101701	4	1/8	12	8	8	18,5	12	10	-
			101702.1	101702	6	1/8	12	6,5	8	18,5	12	12	-
			101703.1	101703	8	1/8	14	8,5	8	20,5	12	14	-
L	315	315	101704.1	101704	6	1/8	14	7	8	22	12	14	101704.4
			101705.1	101705	8	1/4	15	8	12	23	17	17	101705.4
			101706.1	101706	10	1/4	16	9	12	24	17	19	101706.4
			101707.1	101707	12	3/8	17	10	12	24,5	19	22	101707.4
			101708.1	101708	15	1/2	18	11	14	26	24	27	101708.4
			101709.1	101709	18	1/2	19	11,5	14	28	27	32	101709.4
	160	160	101710.1	101710	22	3/4	21	13,5	16	30	32	36	101710.4
			101711.1	101711	28	1	22	14,5	18	31	41	41	101711.4
			101712.1	101712	35	1 1/4	25	14,5	20	36	46	50	101712.4
			101713.1	101713	42	1 1/2	27	16	22	39	55	60	101713.4
S	630	630	101714.1	101714	6	1/4	18	11	12	26	17	17	101714.4
			101715.1	101715	8	1/4	20	13	12	28	17	19	101715.4
			101716.1	101716	10	3/8	20	12,5	12	28,5	19	22	101716.4
			101717.1	101717	12	3/8	22	14,5	12	30,5	22	24	101717.4
	400	400	101718.1	101718	14	1/2	24	16	14	34	24	27	101718.4
			101719.1	101719	16	1/2	24	15,5	14	34	27	30	101719.4
			101720.1	101720	20	3/4	28	17,5	16	39	32	36	101720.4
			101721.1	101721	25	1	32	20	18	44	41	46	101721.4
			101722.1	101722	30	1 1/4	34	20,5	20	47	46	50	101722.4
			101723.1	101723	38	1 1/2	39	23	22	54	55	60	101723.4
L	315	315	101724.1	101724	6	1/4	15	8	12	22,5	14	14	101724.4
			101725.1	101725	8	1/8	15	8	8	22	14	17	101725.4
			101726.1	101726	8	3/8	16	9	12	25	19	17	101726.4
			101727.1	101727	8	1/2	16	9	14	25	22	17	101727.4
			101728.1	101728	10	1/8	16	9	8	24	17	19	101728.4
			101729.1	101729	10	3/8	17	10	12	25	19	19	101729.4
			101730.1	101730	10	1/2	17	10	14	25	22	19	101730.4
			101731.1	101731	12	1/4	17	10	12	24,5	19	22	101731.4
			101732.1	101732	12	1/2	17	10	14	24,5	22	22	101732.4
			101733.1	101733	15	3/8	18	11	12	26	24	27	101733.4
S	630	630	101734.1	101734	18	3/4	19	11,5	16	28	32	32	101734.4
			101735.1	101735	12	1/2	22	14,5	14	30,5	22	24	101735.4
	400	400	101736.1	101736	14	3/8	24	16	12	34	24	27	101736.4
			101737.1	101737	16	3/8	24	15,5	12	34	27	30	101737.4
			101738.1	101738	20	1/2	28	17,5	14	39	32	36	101738.4
			101739.1	101739	25	3/4	32	20	16	44	41	46	101739.4
101740.1	101740	30	1	34	20,5	18	47	46	50	101740.4			

Note: If you wish to order AISI 316 stainless steel fittings, please change the first two digits from **10....** to **11....** .
 If you wish to order AISI 316 stainless steel fittings with AISI 304 stainless steel nuts, please change the first two digits from **10....** to **14....** .
 Items not included in the ISO 8434-1 Norm.

MALE STUD COUPLING

Thread NPT - Thread Metric Taper

Type: **1018...1** Body
Type: **1019...1** Body

Type: **1018..** B3 Ring
Type: **1019..** B3 Ring

Type: **1018...4** B4 Ring
Type: **1019...4** B4 Ring

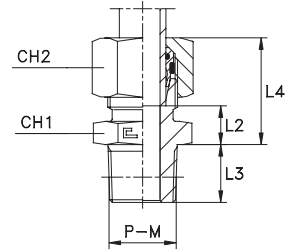
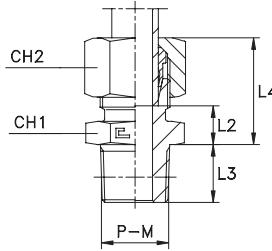
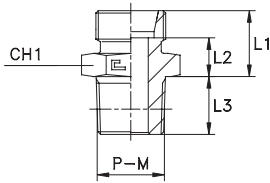

Series DIN	10.... [bar]	11.... [bar]	Ordering Body	Ordering Equipped B3	Ø Tube	P	L1	L2	L3	L4	CH1	CH2	Ordering Completo B4
L	315	315	101804.1	101804	6	1/8	14	7	10	22	12	14	101804.4
			101805.1	101805	8	1/4	15	8	15	23	17	17	101805.4
			101806.1	101806	10	1/4	16	9	15	24	17	19	101806.4
			101807.1	101807	12	3/8	17	10	15	24,5	19	22	101807.4
			101808.1	101808	15	1/2	18,5	11,5	19,5	26,5	24	27	101808.4
	101809.1	101809	18	1/2	19,5	12	19,5	28,5	27	32	101809.4		
	101810.1	101810	22	3/4	21	13,5	20	30	32	36	101810.4		
	101811.1	101811	28	1	22	14,5	25	31	41	41	101811.4		
	101812.1	101812	35	1 1/4	25,5	15	25,5	36,5	46	50	101812.4		
	101813.1	101813	42	1 1/2	27	16	26	39	55	60	101813.4		
S	630	630	101814.1	101814	6	1/4	18	11	15	26	17	17	101814.4
			101815.1	101815	8	1/4	20	13	15	28	17	19	101815.4
			101816.1	101816	10	3/8	20	12,5	15	28,5	19	22	101816.4
			101817.1	101817	12	3/8	22	14,5	15	30,5	22	24	101817.4
			101818.1	101818	14	1/2	24,5	16,5	19,5	34,5	24	27	101818.4
	101819.1	101819	16	1/2	24,5	16	19,5	34,5	27	30	101819.4		
	101820.1	101820	20	3/4	28	17,5	20	39	32	36	101820.4		
	101821.1	101821	25	1	32	20	25	44	41	46	101821.4		
	101822.1	101822	30	1 1/4	34,5	21	25,5	47,5	46	50	101822.4		
	101823.1	101823	38	1 1/2	39	23	26	54	55	60	101823.4		
L	315	315	101824.1	101824	6	1/4	15	8	15	22,5	14	14	101824.4
			101825.1	101825	8	1/8	15	8	10	23	17	17	101825.4
			101826.1	101826	8	3/8	16	9	15	24	19	17	101826.4
			101827.1	101827	8	1/2	16,5	9,5	19,5	24,5	22	17	101827.4
			101828.1	101828	10	1/8	16	9	10	24	17	19	101828.4
			101829.1	101829	10	3/8	17	10	15	25	19	19	101829.4
			101830.1	101830	10	1/2	17,5	10,5	19,5	25,5	22	19	101830.4
			101831.1	101831	12	1/4	17	10	15	24,5	19	22	101831.4
			101832.1	101832	12	1/2	17,5	10,5	19,5	25	22	22	101832.4
			101833.1	101833	15	3/8	18	11	15	26	24	27	101833.4
101834.1	101834	18	3/4	19	11,5	20	28	32	32	101834.4			
S	630	630	101835.1	101835	12	1/2	22,5	15	19,5	31	22	24	101835.4
			101836.1	101836	14	3/8	24	16	15	34	24	27	101836.4
	101837.1	101837	16	3/8	24	15,5	15	34	27	30	101837.4		
	101838.1	101838	20	1/2	28,5	18	19,5	39,5	32	36	101838.4		
	101839.1	101839	25	3/4	32	20	20	44	41	46	101839.4		
	101840.1	101840	30	1	34	20,5	25	47	46	50	101840.4		

Note: If you wish to order AISI 316 stainless steel fittings, please change the first two digits from **10....** to **11....** .
If you wish to order AISI 316 stainless steel fittings with AISI 304 stainless steel nuts, please change the first two digits from **10....** to **14....** .
Items not included in the ISO 8434-1 Norm.

Series DIN	10.... [bar]	11.... [bar]	Ordering Body	Ordering Equipped B3	Ø Tube	M	L1	L2	L3	L4	CH1	CH2	Ordering Equipped B4
L	315	315	101904.1	101904	6	10x1	14	7	8	22	12	14	101904.4
			101905.1	101905	8	12x1,5	15	8	12	23	17	17	101905.4
			101906.1	101906	10	14x1,5	16	9	12	24	17	19	101906.4
			101907.1	101907	12	16x1,5	17	10	12	24,5	19	22	101907.4
			101908.1	101908	15	18x1,5	18	11	12	26	24	27	101908.4
			101909.1	101909	18	22x1,5	19	11,5	14	28	27	32	101909.4
S	630	630	101914.1	101914	6	12x1,5	18	11	12	26	17	17	101914.4
			101915.1	101915	8	14x1,5	20	13	12	28	17	19	101915.4
			101916.1	101916	10	16x1,5	20	12,5	12	28,5	19	22	101916.4
	101917.1	101917	12	18x1,5	22	14,5	12	30,5	22	24	101917.4		
	101918.1	101918	14	20x1,5	24	16	14	34	24	27	101918.4		
	101919.1	101919	16	22x1,5	24	15,5	14	34	27	30	101919.4		

Note: If you wish to order AISI 316 stainless steel fittings, please change the first two digits from **10....** to **11....** .
If you wish to order AISI 316 stainless steel fittings with AISI 304 stainless steel nuts, please change the first two digits from **10....** to **14....** .
Items not included in the ISO 8434-1 Norm available on request only.

MALE STUD ELBOW

Thread BSP Taper

Type: **1020...1** Body

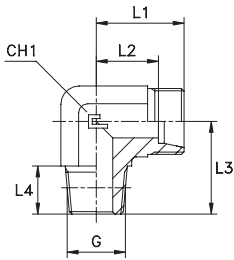

Type: **1020.. B3** Ring

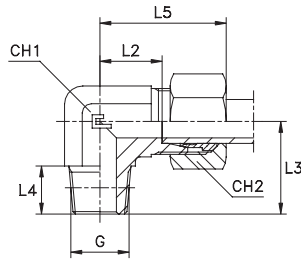

Type: **1020...4** B4 Ring

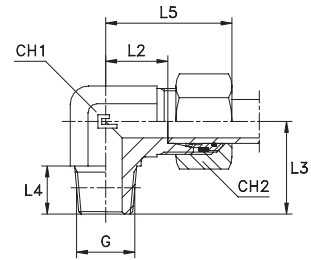

Series DIN	10.... [bar]	11.... [bar]	Ordering Body	Ordering Equipped B3	Ø Tube	G	L1	L2	L3	L4	L5	CH1	CH2	Ordering Equipped B4
LL	100	100	102001.1	102001	4	1/8	15	11	17	8	21	9	10	-
			102002.1	102002	6	1/8	15	9,5	17	8	21	9	12	-
			102003.1	102003	8	1/8	17	11,5	20	8	23	12	14	-
L	315	315	102004.1	102004	6	1/8	19	12	20	8	27	12	14	102004.4
			102005.1	102005	8	1/4	21	14	26	12	29	12	17	102005.4
			102006.1	102006	10	1/4	22	15	27	12	30	14	19	102006.4
			102007.1	102007	12	3/8	24	17	28	12	32	17	22	102007.4
			102008.1	102008	15	1/2	28	21	34	14	36	19	27	102008.4
			102009.1	102009	18	1/2	31	23,5	36	14	40	24	32	102009.4
	160	160	102010.1	102010	22	3/4	35	27,5	42	16	44	27	36	102010.4
			102011.1	102011	28	1	38	30,5	48	18	47	36	41	102011.4
			102012.1	102012	35	1 1/4	45	34,5	54	20	56	41	50	102012.4
			102013.1	102013	42	1 1/2	51	40	61	22	63	50	60	102013.4
S	630	630	102014.1	102014	6	1/4	23	16	26	12	31	12	17	102014.4
			102015.1	102015	8	1/4	24	17	27	12	32	14	19	102015.4
			102016.1	102016	10	3/8	25	17,5	28	12	34	17	22	102016.4
			102017.1	102017	12	3/8	29	21,5	28	12	38	17	24	102017.4
			102018.1	102018	14	1/2	30	22	32	14	40	19	27	102018.4
	400	400	102019.1	102019	16	1/2	33	24,5	32	14	43	24	30	102019.4
			102020.1	102020	20	3/4	37	26,5	42	16	48	27	36	102020.4
			102021.1	102021	25	1	42	30	48	18	54	36	46	102021.4
			102022.1	102022	30	1 1/4	49	35,5	54	20	62	41	50	102022.4
			102023.1	102023	38	1 1/2	57	41	61	22	72	50	60	102023.4
L	315	315	102024.1	102024	6	1/4	21	14	26	12	29	12	14	102024.4
			102025.1	102025	8	1/8	21	14	22	8	29	12	17	102025.4
			102026.1	102026	8	3/8	23	16	28	12	31	17	17	102026.4
			102027.1	102027	8	1/2	26	19	34	14	34	19	17	102027.4
			102028.1	102028	10	1/8	22	15	22	8	30	14	19	102028.4
			102029.1	102029	10	3/8	24	17	28	12	32	17	19	102029.4
			102030.1	102030	10	1/2	27	20	34	14	35	19	19	102030.4
			102031.1	102031	12	1/4	24	17	28	12	32	17	22	102031.4
			102032.1	102032	12	1/2	27	20	34	14	34	19	22	102032.4
			102033.1	102033	15	3/8	28	21	30	12	36	19	27	102033.4
102034.1	102034	18	3/4	34	26,5	42	16	43	27	32	102034.4			
S	630	630	102035.1	102035	12	1/2	28	20,5	32	14	37	19	24	102035.4
			102036.1	102036	14	3/8	30	22	30	12	40	19	27	102036.4
	400	400	102037.1	102037	16	3/8	33	24,5	37	12	43	24	30	102037.4
			102038.1	102038	20	1/2	37	26,5	36	14	48	27	36	102038.4
			102039.1	102039	25	3/4	42	30	42	16	54	36	46	102039.4
			102040.1	102040	30	1	49	35,5	48	18	62	41	50	102040.4

Note: If you wish to order AISI 316 stainless steel fittings, please change the first two digits from **10....** to **11....** .
 If you wish to order AISI 316 stainless steel fittings with AISI 304 stainless steel nuts, please change the first two digits from **10....** to **14....** .
 Items not included in the ISO 8434-1 Norm.

MALE STUD ELBOW

Thread NPT - Thread Metric Taper

Type: **1021...1** Body
Type: **1022...1** Body

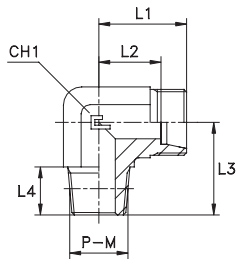

Type: **1021.. B3** Ring
Type: **1022.. B3** Ring

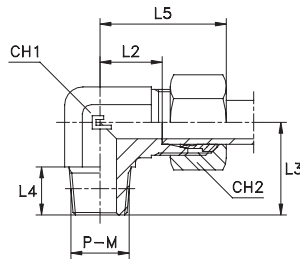

Type: **1021...4 B4** Ring
Type: **1022...4 B4** Ring

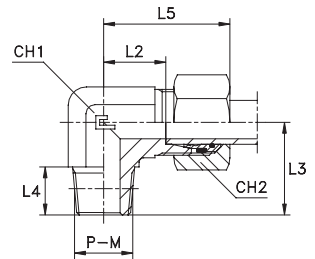

Series DIN	10.... [bar]	11.... [bar]	Ordering Body	Ordering Equipped B3	Ø Tube	P	L1	L2	L3	L4	L5	CH1	CH2	Ordering Equipped B4
L	315	315	102104.1	102104	6	1/8	19	12	20	10	27	12	14	102104.4
			102105.1	102105	8	1/4	21	14	26	15	29	12	17	102105.4
			102106.1	102106	10	1/4	22	15	27	15	30	14	19	102106.4
			102107.1	102107	12	3/8	24	17	28	15	32	17	22	102107.4
			102108.1	102108	15	1/2	28	21	34	19.5	36	19	27	102108.4
			102109.1	102109	18	1/2	31	23.5	36	19.5	40	24	32	102109.4
	160	160	102110.1	102110	22	3/4	35	27.5	42	20	44	27	36	102110.4
			102111.1	102111	28	1	38	30.5	48	25	47	36	41	102111.4
			102112.1	102112	35	1 1/4	45	34.5	57	25.5	56	41	50	102112.4
			102113.1	102113	42	1 1/2	51	40	61	26	63	50	60	102113.4
			102114.1	102114	6	1/4	23	16	26	15	31	12	17	102114.4
			102115.1	102115	8	1/4	24	17	27	15	32	14	19	102115.4
S	630	630	102116.1	102116	10	3/8	25	17.5	28	15	34	17	22	102116.4
			102117.1	102117	12	3/8	29	21.5	28	15	38	17	24	102117.4
			102118.1	102118	14	1/2	30	22	34	19.5	40	19	27	102118.4
			102119.1	102119	16	1/2	33	24.5	36	19.5	43	24	30	102119.4
			102120.1	102120	20	3/4	37	26.5	42	20	48	27	36	102120.4
			102121.1	102121	25	1	42	30	48	25	54	36	46	102121.4
	400	400	102122.1	102122	30	1 1/4	49	35.5	57	25.5	62	41	50	102122.4
			102123.1	102123	38	1 1/2	57	41	61	26	72	50	60	102123.4
			102124.1	102124	6	1/4	21	14	26	15	29	12	14	102124.4
			102125.1	102125	8	1/8	21	14	24	10	29	12	17	102125.4
			102126.1	102126	8	3/8	23	16	28	15	31	17	17	102126.4
			102127.1	102127	8	1/2	26	19	34	19.5	34	19	17	102127.4
L	315	315	102128.1	102128	10	1/8	22	15	24	10	30	14	19	102128.4
			102129.1	102129	10	3/8	24	17	28	15	32	17	19	102129.4
			102130.1	102130	10	1/2	27	20	34	19.5	35	19	19	102130.4
			102131.1	102131	12	1/4	24	17	28	15	32	17	22	102131.4
			102132.1	102132	12	1/2	27	20	34	19.5	35	19	22	102132.4
			102133.1	102133	15	3/8	28	21	33	15	36	19	27	102133.4
			102134.1	102134	18	3/4	34	26.5	42	20	43	27	32	102134.4
			102135.1	102135	12	1/2	28	20.5	34	19.5	37	19	24	102135.4
			102136.1	102136	14	3/8	30	22	33	15	40	19	27	102136.4
			102137.1	102137	16	3/8	33	24.5	37	15	43	24	30	102137.4
			102138.1	102138	20	1/2	37	26.5	42	19.5	48	27	36	102138.4
			102139.1	102139	25	3/4	42	30	46	20	54	36	46	102139.4
102140.1	102140	30	1	49	35.5	55	25	62	41	50	102140.4			
S	630	630	102135.1	102135	12	1/2	28	20.5	34	19.5	37	19	24	102135.4
			102136.1	102136	14	3/8	30	22	33	15	40	19	27	102136.4
			102137.1	102137	16	3/8	33	24.5	37	15	43	24	30	102137.4
	400	400	102138.1	102138	20	1/2	37	26.5	42	19.5	48	27	36	102138.4
			102139.1	102139	25	3/4	42	30	46	20	54	36	46	102139.4
			102140.1	102140	30	1	49	35.5	55	25	62	41	50	102140.4

Note: If you wish to order AISI 316 stainless steel fittings, please change the first two digits from **10...** to **11...** .
If you wish to order AISI 316 stainless steel fittings with AISI 304 stainless steel nuts, please change the first two digits from **10....** to **14....** .
Items not included in the ISO 8434-1 Norm.

Series DIN	10.... [bar]	11.... [bar]	Ordering Body	Ordering Equipped B3	Ø Tube	M	L1	L2	L3	L4	L5	CH1	CH2	Ordering Equipped B4
L	315	315	102204.1	102204	6	10x1	19	12	20	8	27	12	14	102204.4
			102205.1	102205	8	12x1.5	21	14	26	12	29	12	17	102205.4
			102206.1	102206	10	14x1.5	22	15	27	12	30	14	19	102206.4
			102207.1	102207	12	16x1.5	24	17	28	12	32	17	22	102207.4
			102208.1	102208	15	18x1.5	28	21	32	12	36	19	27	102208.4
			102209.1	102209	18	22x1.5	31	23.5	36	14	40	24	32	102209.4
S	630	630	102214.1	102214	6	12x1.5	23	16	26	12	31	12	17	102214.4
			102215.1	102215	8	14x1.5	24	17	27	12	32	14	19	102215.4
			102216.1	102216	10	16x1.5	25	17.5	28	12	34	17	22	102216.4
			102217.1	102217	12	18x1.5	29	21.5	28	12	38	17	24	102217.4
			102218.1	102218	14	20x1.5	30	22	32	14	40	19	27	102218.4
			102219.1	102219	16	22x1.5	33	24.5	32	14	43	24	30	102219.4

Note: If you wish to order AISI 316 stainless steel fittings, please change the first two digits from **10....** to **11....** .
If you wish to order AISI 316 stainless steel fittings with AISI 304 stainless steel nuts, please change the first two digits from **10....** to **14....** .
Items not included in the ISO 8434-1 Norm available on request only.

MALE STUD BRANCH TEE

Thread BSP Taper - Thread NPT

Type: **1025...1** Body
 Type: **1026...1** Body

Type: **1025..** B3 Ring
 Type: **1026..** B3 Ring

Type: **1025...4** B4 Ring
 Type: **1026...4** B4 Ring

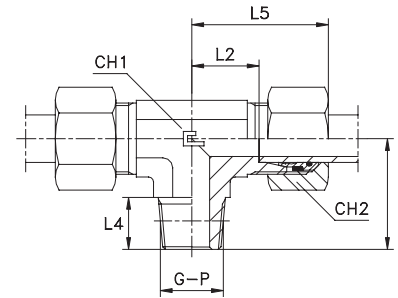
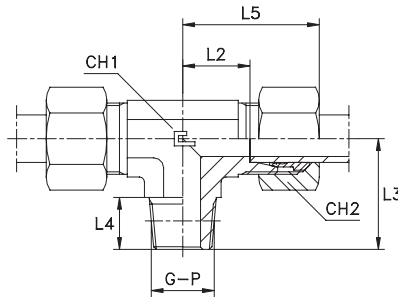
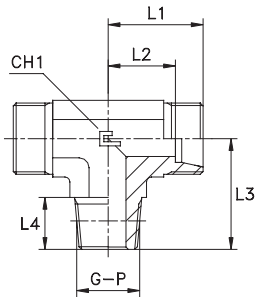

Series DIN	10.... [bar]	11.... [bar]	Ordering Body	Ordering Equipped B3	Ø Tube	G	L1	L2	L3	L4	L5	CH1	CH2	Ordering Equipped B4
LL	100	100	102501.1	102501	4	1/8	15	11	17	8	21	9	10	-
			102502.1	102502	6	1/8	15	9.5	17	8	21	9	12	-
			102503.1	102503	8	1/8	17	11.5	20	8	23	12	14	-
L	315	315	102504.1	102504	6	1/8	19	12	20	8	27	12	14	102504.4
			102505.1	102505	8	1/4	21	14	26	12	29	12	17	102505.4
			102506.1	102506	10	1/4	22	15	27	12	30	14	19	102506.4
			102507.1	102507	12	3/8	24	17	28	12	32	17	22	102507.4
			102508.1	102508	15	1/2	28	21	34	14	36	19	27	102508.4
			102509.1	102509	18	1/2	31	23.5	36	14	40	24	32	102509.4
	160	160	102510.1	102510	22	3/4	35	27.5	42	16	44	27	36	102510.4
			102511.1	102511	28	1	38	30.5	48	18	47	36	41	102511.4
			102512.1	102512	35	1 1/4	45	34.5	54	20	56	41	50	102512.4
			102513.1	102513	42	1 1/2	51	40	61	22	63	50	60	102513.4
S	630	630	102514.1	102514	6	1/4	23	16	26	12	31	12	17	102514.4
			102515.1	102515	8	1/4	24	17	27	12	32	14	19	102515.4
			102516.1	102516	10	3/8	25	17.5	28	12	34	17	22	102516.4
			102517.1	102517	12	3/8	29	21.5	28	12	38	17	24	102517.4
	400	400	102518.1	102518	14	1/2	30	22	32	14	40	19	27	102518.4
			102519.1	102519	16	1/2	33	24.5	32	14	43	24	30	102519.4
			102520.1	102520	20	3/4	37	26.5	42	16	48	27	36	102520.4
			102521.1	102521	25	1	42	30	48	18	54	36	46	102521.4
			102522.1	102522	30	1 1/4	49	35.5	54	20	62	41	50	102522.4
			102523.1	102523	38	1 1/2	57	41	61	22	72	50	60	102523.4

Note: If you wish to order AISI 316 stainless steel fittings, please change the first two digits from **10....** to **11....** .
 If you wish to order AISI 316 stainless steel fittings with AISI 304 stainless steel nuts, please change the first two digits from **10....** to **14....** .
 Items not included in the ISO 8434-1 Norm available on scheduled orders only

Series DIN	10.... [bar]	11.... [bar]	Ordering Body	Ordering Equipped B3	Ø Tube	P	L1	L2	L3	L4	L5	CH1	CH2	Ordering Equipped B4
L	315	315	102604.1	102604	6	1/8	19	12	20	10	27	12	14	102604.4
			102605.1	102605	8	1/4	21	14	26	15	29	12	17	102605.4
			102606.1	102606	10	1/4	22	15	27	15	30	14	19	102606.4
			102607.1	102607	12	3/8	24	17	28	15	32	17	22	102607.4
			102608.1	102608	15	1/2	28	21	34	19.5	36	19	27	102608.4
			102609.1	102609	18	1/2	31	23.5	36	19.5	40	24	32	102609.4
S	630	630	102610.1	102610	22	3/4	35	27.5	42	20	44	27	36	102610.4
			102611.1	102611	28	1	38	30.5	48	25	47	36	41	102611.4
			102612.1	102612	35	1 1/4	45	34.5	57	25.5	56	41	50	102612.4
			102613.1	102613	42	1 1/2	51	40	61	26	63	50	60	102613.4
			102614.1	102614	6	1/4	23	16	26	15	31	12	17	102614.4
			102615.1	102615	8	1/4	24	17	27	15	32	14	19	102615.4
400	400	102616.1	102616	10	3/8	25	17.5	28	15	34	17	22	102616.4	
		102617.1	102617	12	3/8	29	21.5	28	15	38	17	24	102617.4	
		102618.1	102618	14	1/2	30	22	34	19.5	40	19	27	102618.4	
		102619.1	102619	16	1/2	33	24.5	36	19.5	43	24	30	102619.4	
		102620.1	102620	20	3/4	37	26.5	42	20	48	27	36	102620.4	
		102621.1	102621	25	1	42	30	48	25	54	36	46	102621.4	
315	315	102622.1	102622	30	1 1/4	49	35.5	57	25.5	62	41	50	102622.4	
		102623.1	102623	38	1 1/2	57	41	61	26	72	50	60	102623.4	

Note: If you wish to order AISI 316 stainless steel fittings, please change the first two digits from **10....** to **11....** .
 If you wish to order AISI 316 stainless steel fittings with AISI 304 stainless steel nuts, please change the first two digits from **10....** to **14....** .
 Items not included in the ISO 8434-1 Norm available on scheduled orders only

MALE STUD BARREL TEE

Thread BSP Taper - Thread NPT

Type: **1030...1** Body
Type: **1031...1** Body

Type: **1030.. B3** Ring
Type: **1031.. B3** Ring

Type: **1030...4** B4 Ring
Type: **1031...4** B4 Ring

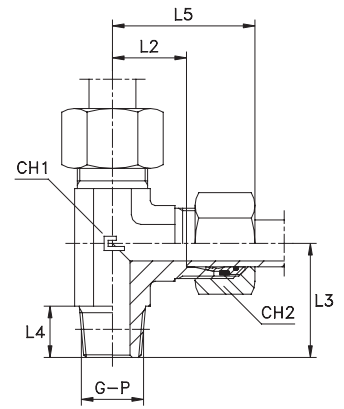
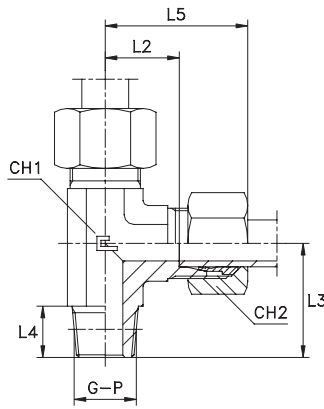
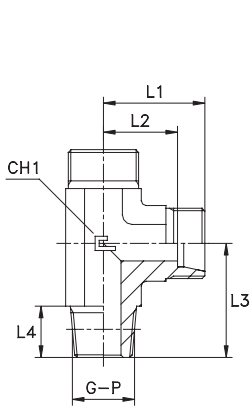

Series DIN	10.... [bar]	11.... [bar]	Ordering Body	Ordering Equipped B3	Ø Tube	G	L1	L2	L3	L4	L5	CH1	CH2	Ordering Equipped B4
LL	100	100	103001.1	103001	4	1/8	15	11	17	8	21	9	10	-
			103002.1	103002	6	1/8	15	9.5	17	8	21	9	12	-
			103003.1	103003	8	1/8	17	11.5	20	8	23	12	14	-
L	315	315	103004.1	103004	6	1/8	19	12	20	8	27	12	14	103004.4
			103005.1	103005	8	1/4	21	14	26	12	29	12	17	103005.4
			103006.1	103006	10	1/4	22	15	27	12	30	14	19	103006.4
			103007.1	103007	12	3/8	24	17	28	12	32	17	22	103007.4
			103008.1	103008	15	1/2	28	21	34	14	36	19	27	103008.4
			103009.1	103009	18	1/2	31	23.5	36	14	40	24	32	103009.4
	160	160	103010.1	103010	22	3/4	35	27.5	42	16	44	27	36	103010.4
			103011.1	103011	28	1	38	30.5	48	18	47	36	41	103011.4
			103012.1	103012	35	1 1/4	45	34.5	54	20	56	41	50	103012.4
			103013.1	103013	42	1 1/2	51	40	61	22	63	50	60	103013.4
S	630	630	103014.1	103014	6	1/4	23	16	26	12	31	12	17	103014.4
			103015.1	103015	8	1/4	24	17	27	12	32	14	19	103015.4
			103016.1	103016	10	3/8	25	17.5	28	12	34	17	22	103016.4
			103017.1	103017	12	3/8	29	21.5	28	12	38	17	24	103017.4
			103018.1	103018	14	1/2	30	22	32	14	40	19	27	103018.4
			103019.1	103019	16	1/2	33	24.5	32	14	43	24	30	103019.4
	400	400	103020.1	103020	20	3/4	37	26.5	42	16	48	27	36	103020.4
			103021.1	103021	25	1	42	30	48	18	54	36	46	103021.4
			103022.1	103022	30	1 1/4	49	35.5	54	20	62	41	50	103022.4
			103023.1	103023	38	1 1/2	57	41	61	22	72	50	60	103023.4

Note: If you wish to order AISI 316 stainless steel fittings, please change the first two digits from **10....** to **11....** .
If you wish to order AISI 316 stainless steel fittings with AISI 304 stainless steel nuts, please change the first two digits from **10....** to **14....** .
Items not included in the ISO 8434-1 Norm available on scheduled orders only

Series DIN	10.... [bar]	11.... [bar]	Ordering Body	Ordering Equipped B3	Ø Tube	P	L1	L2	L3	L4	L5	CH1	CH2	Ordering Equipped B4
L	315	315	103104.1	103104	6	1/8	19	12	20	10	27	12	14	103104.4
			103105.1	103105	8	1/4	21	14	26	15	29	12	17	103105.4
			103106.1	103106	10	1/4	22	15	27	15	30	14	19	103106.4
			103107.1	103107	12	3/8	24	17	28	15	32	17	22	103107.4
			103108.1	103108	15	1/2	28	21	34	19.5	36	19	27	103108.4
			103109.1	103109	18	1/2	31	23.5	36	19.5	40	24	32	103109.4
S	630	630	103110.1	103110	22	3/4	35	27.5	42	20	44	27	36	103110.4
			103111.1	103111	28	1	38	30.5	48	25	47	36	41	103111.4
			103112.1	103112	35	1 1/4	45	34.5	57	25.5	56	41	50	103112.4
			103113.1	103113	42	1 1/2	51	40	61	26	63	50	60	103113.4
			103114.1	103114	6	1/4	23	16	26	15	31	12	17	103114.4
			103115.1	103115	8	1/4	24	17	27	15	32	14	19	103115.4
	400	400	103116.1	103116	10	3/8	25	17.5	28	15	34	17	22	103116.4
			103117.1	103117	12	3/8	29	21.5	28	15	38	17	24	103117.4
			103118.1	103118	14	1/2	30	22	34	19.5	40	19	27	103118.4
			103119.1	103119	16	1/2	33	24.5	36	19.5	43	24	30	103119.4
315	315	103120.1	103120	20	3/4	37	26.5	42	20	48	27	36	103120.4	
		103121.1	103121	25	1	42	30	48	25	54	36	46	103121.4	
		103122.1	103122	30	1 1/4	49	35.5	57	25.5	62	41	50	103122.4	
		103123.1	103123	38	1 1/2	57	41	61	26	72	50	60	103123.4	

Note: If you wish to order AISI 316 stainless steel fittings, please change the first two digits from **10....** to **11....** .
If you wish to order AISI 316 stainless steel fittings with AISI 304 stainless steel nuts, please change the first two digits from **10....** to **14....** .
Items not included in the ISO 8434-1 Norm available on scheduled orders only

STRAIGHT COUPLING

Type: 1035...1 Body

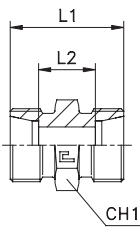

Type: 1035.. B3 Ring

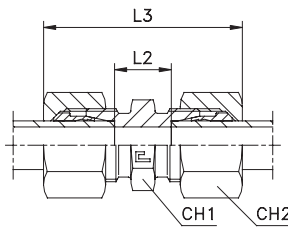

Type: 1035...4 B4 Ring

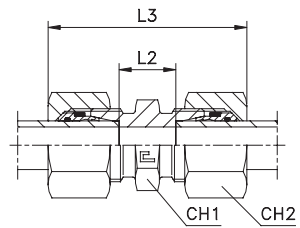

Series DIN	10.... [bar]	11.... [bar]	Ordering Body	Ordering Equipped B3	Ø Tube	L1	L2	L3	CH1	CH2	Ordering Equipped B4
LL	100	100	103501.1	103501	4	20	12	31	12	10	-
			103502.1	103502	6	20	9	32	12	12	-
			103503.1	103503	8	23	12	35	12	14	-
L	500	315	103504.1	103504	6	24	10	39	12	14	103504.4
			103505.1	103505	8	25	11	40	14	17	103505.4
			103506.1	103506	10	27	13	42	17	19	103506.4
	400	315	103507.1	103507	12	28	14	43	19	22	103507.4
			103508.1	103508	15	30	16	46	24	27	103508.4
			103509.1	103509	18	31	16	48	27	32	103509.4
	250	160	103510.1	103510	22	35	20	52	32	36	103510.4
			103511.1	103511	28	36	21	54	41	41	103511.4
			103512.1	103512	35	41	20	63	46	50	103512.4
103513.1			103513	42	43	21	66	55	60	103513.4	
103514.1			103514	6	30	16	45	14	17	103514.4	
103515.1			103515	8	32	18	47	17	19	103515.4	
S	800	630	103516.1	103516	10	32	17	49	19	22	103516.4
			103517.1	103517	12	34	19	51	22	24	103517.4
			103518.1	103518	14	38	22	57	24	27	103518.4
	630	630	103519.1	103519	16	38	21	57	27	30	103519.4
			103520.1	103520	20	44	23	66	32	36	103520.4
			103521.1	103521	25	50	26	74	41	46	103521.4
	420	400	103522.1	103522	30	54	27	80	46	50	103522.4
			103523.1	103523	38	61	29	90	55	60	103523.4

Note: If you wish to order AISI 316 stainless steel fittings, please change the first two digits from 10.... to 11....
If you wish to order AISI 316 stainless steel fittings with AISI 304 stainless steel nuts, please change the first two digits from 10.... to 14....

BULKHEAD CONNECTION

Type: 1036...1 Body

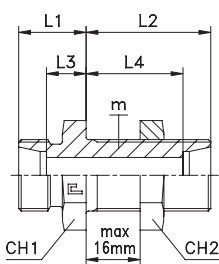

Type: 1036.. B3 Ring

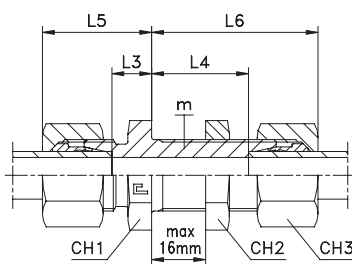

Type: 1036...4 B4 Ring

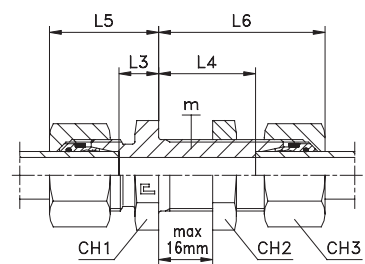

Series	10.... [bar]	11.... [bar]	Ordering Body	Ordering Equipped B3	Ø Tube	m	L1	L2	L3	L4	L5	L6	CH1	CH2	CH3	Ordering Equipped B4
L	500	315	103604.1	103604	6	12x1.5	14	34	7	27	22	42	17	17	14	103604.4
			103605.1	103605	8	14x1.5	15	34	8	27	23	42	19	19	17	103605.4
			103606.1	103606	10	16x1.5	17	35	10	28	25	43	22	22	19	103606.4
	400	315	103607.1	103607	12	18x1.5	17	36	10	29	25	44	24	24	22	103607.4
			103608.1	103608	15	22x1.5	19	38	12	31	27	46	27	30	27	103608.4
			103609.1	103609	18	26x1.5	21	40	13.5	32.5	30	49	32	36	32	103609.4
	250	160	103610.1	103610	22	30x2	24	42	16.5	34.5	33	51	36	41	36	103610.4
			103611.1	103611	28	36x2	26	43	18.5	35.5	35	52	41	46	41	103611.4
			103612.1	103612	35	45x2	29	47	18.5	36.5	40	58	50	55	50	103612.4
103613.1	103613	42	52x2	30	47	19	36	42	59	60	65	60	103613.4			
S	800	630	103614.1	103614	6	14x1.5	19	36	12	29	27	44	19	19	17	103614.4
			103615.1	103615	8	16x1.5	20	36	13	29	28	44	22	22	19	103615.4
			103616.1	103616	10	18x1.5	22	37	14.5	29.5	31	46	24	24	22	103616.4
	630	630	103617.1	103617	12	20x1.5	22	38	14.5	30.5	31	47	27	27	24	103617.4
			103618.1	103618	14	22x1.5	25	40	17	32	35	50	30	30	27	103618.4
			103619.1	103619	16	24x1.5	25	40	16.5	31.5	35	50	32	32	30	103619.4
	420	400	103620.1	103620	20	30x2	28	44	17.5	33.5	39	55	41	41	36	103620.4
			103621.1	103621	25	36x2	32	47	20	35	44	59	46	46	46	103621.4
			103622.1	103622	30	42x2	35	51	21.5	37.5	48	64	50	50	50	103622.4
103623.1	103623	38	52x2	38	53	22	37	53	68	65	65	60	103623.4			

Note: If you wish to order AISI 316 stainless steel fittings, please change the first two digits from 10.... to 11....
If you wish to order AISI 316 stainless steel fittings with AISI 304 stainless steel nuts, please change the first two digits from 10.... to 14....

BULKHEAD ELBOW

Type: **1037...1** Body

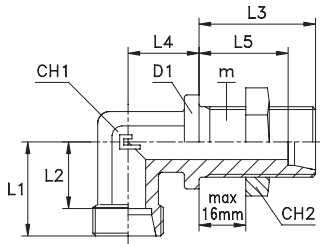

Type: **1037.. B3** Ring

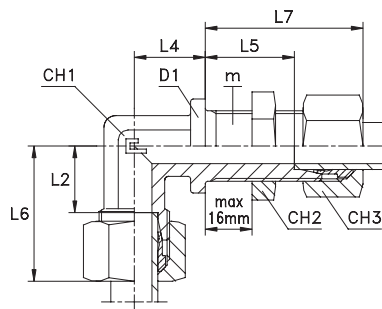

Type: **1037...4** B4 Ring

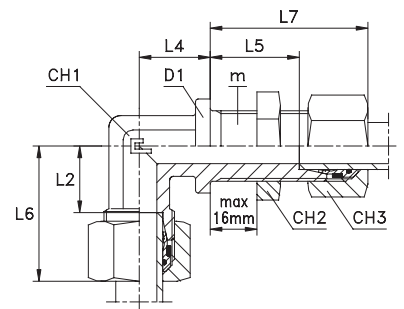

Series DIN	10.... [bar]	11.... [bar]	Ordering Body	Ordering Equipped B3	Ø Tube	m	L1	L2	L3	L4	L5	L6	L7	D1	CH1	CH2	CH3	Ordering Equipped B4
L	315	315	103704.1	103704	6	12x1,5	19	12	34	14	27	27	42	17	12	17	14	103704.4
			103705.1	103705	8	14x1,5	21	14	34	17	27	29	42	19	12	19	17	103705.4
			103706.1	103706	10	16x1,5	22	15	35	18	28	30	43	22	14	22	19	103706.4
			103707.1	103707	12	18x1,5	24	17	36	20	29	32	44	24	17	24	22	103707.4
			103708.1	103708	15	22x1,5	28	21	38	23	31	36	46	27	19	30	27	103708.4
	103709.1	103709	18	26x1,5	31	23,5	40	24	32,5	40	49	32	24	36	32	103709.4		
	103710.1	103710	22	30x2	35	27,5	42	30	34,5	44	51	36	27	41	36	103710.4		
	103711.1	103711	28	36x2	38	30,5	43	34	35,5	47	52	42	36	46	41	103711.4		
	103712.1	103712	35	45x2	45	34,5	47	39	36,5	56	58	50	41	55	50	103712.4		
	103713.1	103713	42	52x2	51	40	47	43	36	63	59	60	50	65	60	103713.4		
S	630	630	103714.1	103714	6	14x1,5	23	16	36	17	29	31	44	19	12	19	17	103714.4
			103715.1	103715	8	16x1,5	24	17	36	18	29	32	44	22	14	22	19	103715.4
			103716.1	103716	10	18x1,5	25	17,5	37	20	29,5	34	46	24	17	24	22	103716.4
			103717.1	103717	12	20x1,5	29	21,5	38	21	30,5	38	47	27	17	27	24	103717.4
			103718.1	103718	14	22x1,5	30	22	40	23	32	40	50	27	19	30	27	103718.4
	103719.1	103719	16	24x1,5	33	24,5	40	24	31,5	43	50	30	24	32	30	103719.4		
	400	400	103720.1	103720	20	30x2	37	26,5	44	30	33,5	48	55	36	27	41	36	103720.4
			103721.1	103721	25	36x2	42	30	47	34	35	54	59	42	36	46	46	103721.4
			103722.1	103722	30	42x2	49	35,5	51	39	37,5	62	64	50	41	50	50	103722.4
	315	315	103723.1	103723	38	52x2	57	41	53	43	37	72	68	60	50	65	60	103723.4

Note: If you wish to order AISI 316 stainless steel fittings, please change the first two digits from **10....** to **11....** .
If you wish to order AISI 316 stainless steel fittings with AISI 304 stainless steel nuts, please change the first two digits from **10....** to **14....** .

EQUAL ELBOW

Type: **1038...1** Body

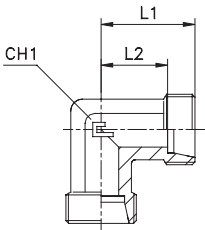

Type: **1038.. B3** Ring

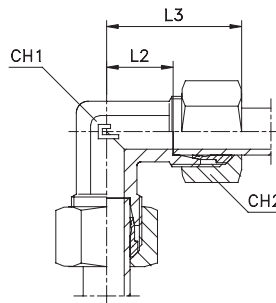

Type: **1038...4** B4 Ring

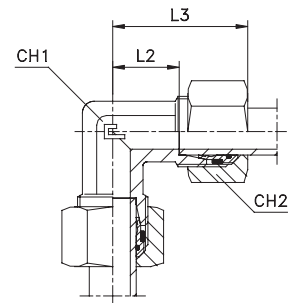

Series DIN	10.... [bar]	11.... [bar]	Ordering Body	Ordering Equipped B3	Ø Tube	L1	L2	L3	CH1	CH2	Ordering Equipped B4
LL	100	100	103801.1	103801	4	15	11	21	9	10	-
			103802.1	103802	6	15	9,5	21	9	12	-
			103803.1	103803	8	17	11,5	23	12	14	-
L	500	315	103804.1	103804	6	19	12	27	12	14	103804.4
			103805.1	103805	8	21	14	29	12	17	103805.4
			103806.1	103806	10	22	15	30	14	19	103806.4
	400	315	103807.1	103807	12	24	17	32	17	22	103807.4
			103808.1	103808	15	28	21	36	19	27	103808.4
			103809.1	103809	18	31	23,5	40	24	32	103809.4
			103810.1	103810	22	35	27,5	44	27	36	103810.4
250	160	103811.1	103811	28	38	30,5	47	36	41	103811.4	
		103812.1	103812	35	45	34,5	56	41	50	103812.4	
		103813.1	103813	42	51	40	63	50	60	103813.4	
S	800	630	103814.1	103814	6	23	16	31	12	17	103814.4
			103815.1	103815	8	24	17	32	14	19	103815.4
			103816.1	103816	10	25	17,5	34	17	22	103816.4
	630	630	103817.1	103817	12	29	21,5	38	17	24	103817.4
			103818.1	103818	14	30	22	40	19	27	103818.4
			103819.1	103819	16	33	24,5	43	24	30	103819.4
	420	400	103820.1	103820	20	37	26,5	48	27	36	103820.4
			103821.1	103821	25	42	30	54	36	46	103821.4
			103822.1	103822	30	49	35,5	62	41	50	103822.4
			103823.1	103823	38	57	41	72	50	60	103823.4

Note: If you wish to order AISI 316 stainless steel fittings, please change the first two digits from **10....** to **11....** .
If you wish to order AISI 316 stainless steel fittings with AISI 304 stainless steel nuts, please change the first two digits from **10....** to **14....** .

EQUAL TEE

Type: **1039...1** Body

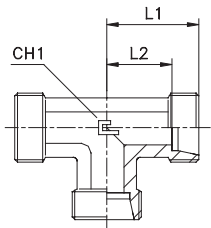

Type: **1039.. B3 Ring**

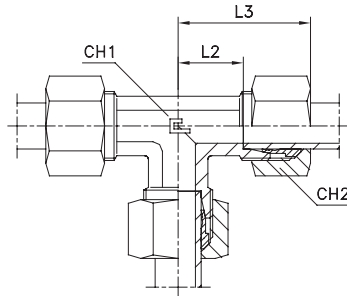

Type: **1039...4 B4 Ring**

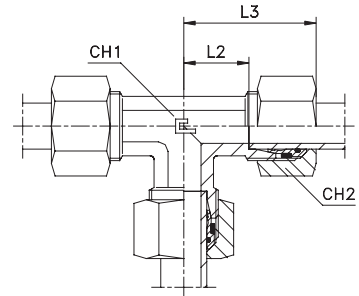

Series DIN	10.... [bar]	11.... [bar]	Ordering Body	Ordering Equipped B3	Ø Tube	L1	L2	L3	CH1	CH2	Ordering Equipped B4
LL	100	100	103901.1	103901	4	15	11	21	9	10	-
			103902.1	103902	6	15	9.5	21	9	12	-
			103903.1	103903	8	17	11.5	23	12	14	-
L	500	315	103904.1	103904	6	19	12	27	12	14	103904.4
			103905.1	103905	8	21	14	29	12	17	103905.4
			103906.1	103906	10	22	15	30	14	19	103906.4
			103907.1	103907	12	24	17	32	17	22	103907.4
			103908.1	103908	15	28	21	36	19	27	103908.4
	400	160	103909.1	103909	18	31	23.5	40	24	32	103909.4
			103910.1	103910	22	35	27.5	44	27	36	103910.4
			103911.1	103911	28	38	30.5	47	36	41	103911.4
			103912.1	103912	35	45	34.5	56	41	50	103912.4
			103913.1	103913	42	51	40	63	50	60	103913.4
S	800	630	103914.1	103914	6	23	16	31	12	17	103914.4
			103915.1	103915	8	24	17	32	14	19	103915.4
			103916.1	103916	10	25	17.5	34	17	22	103916.4
			103917.1	103917	12	29	21.5	38	17	24	103917.4
			103918.1	103918	14	30	22	40	19	27	103918.4
	630	400	103919.1	103919	16	33	24.5	43	24	30	103919.4
			103920.1	103920	20	37	26.5	48	27	36	103920.4
			103921.1	103921	25	42	30	54	36	46	103921.4
			103922.1	103922	30	49	35.5	62	41	50	103922.4
			103923.1	103923	38	57	41	72	50	60	103923.4

Note: If you wish to order AISI 316 stainless steel fittings, please change the first two digits from **10....** to **11....** .
 If you wish to order AISI 316 stainless steel fittings with AISI 304 stainless steel nuts, please change the first two digits from **10....** to **14....** .

EQUAL CROSS

Type: **1040...1** Body

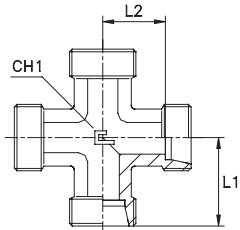

Type: **1040.. B3 Ring**

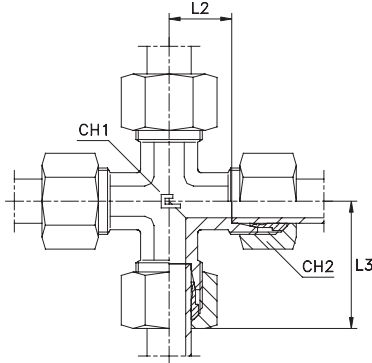

Type: **1040...4 B4 Ring**

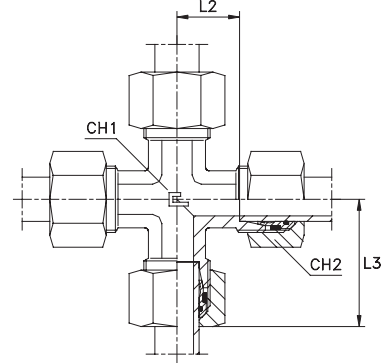

Series DIN	10.... [bar]	11.... [bar]	Ordering Body	Ordering Equipped B3	Ø Tube	L1	L2	L3	CH1	CH2	Ordering Equipped B4
LL	100	100	104001.1	104001	4	15	11	21	9	10	-
			104002.1	104002	6	15	9.5	21	9	12	-
			104003.1	104003	8	17	11.5	23	12	14	-
L	315	315	104004.1	104004	6	19	12	27	12	14	104004.4
			104005.1	104005	8	21	14	29	12	17	104005.4
			104006.1	104006	10	22	15	30	14	19	104006.4
			104007.1	104007	12	24	17	32	17	22	104007.4
			104008.1	104008	15	28	21	36	19	27	104008.4
	160	160	104009.1	104009	18	31	23.5	40	24	32	104009.4
			104010.1	104010	22	35	27.5	44	27	36	104010.4
			104011.1	104011	28	38	30.5	47	36	41	104011.4
			104012.1	104012	35	45	34.5	56	41	50	104012.4
			104013.1	104013	42	51	40	63	50	60	104013.4
S	630	630	104014.1	104014	6	23	16	31	12	17	104014.4
			104015.1	104015	8	24	17	32	14	19	104015.4
			104016.1	104016	10	25	17.5	34	17	22	104016.4
			104017.1	104017	12	29	21.5	38	17	24	104017.4
			104018.1	104018	14	30	22	40	19	27	104018.4
	400	400	104019.1	104019	16	33	24.5	43	24	30	104019.4
			104020.1	104020	20	37	26.5	48	27	36	104020.4
			104021.1	104021	25	42	30	54	36	46	104021.4
			104022.1	104022	30	49	35.5	62	41	50	104022.4
			104023.1	104023	38	57	41	72	50	60	104023.4

Note: If you wish to order AISI 316 stainless steel fittings, please change the first two digits from **10....** to **11....** .
 If you wish to order AISI 316 stainless steel fittings with AISI 304 stainless steel nuts, please change the first two digits from **10....** to **14....** .

STRAIGHT REDUCING COUPLING

Type: **1041...1** Body

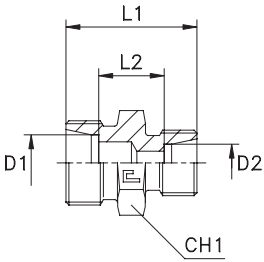

Type: **1041.. B3** Ring

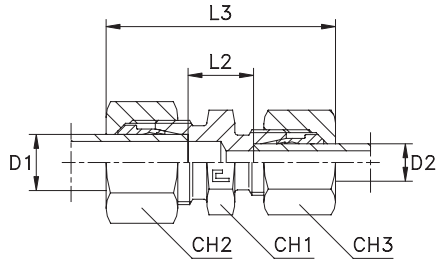

Type: **1041...4** B4 Ring

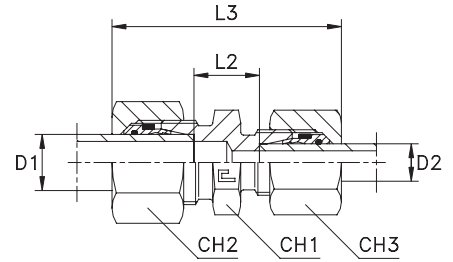

Series DIN	10.... [bar]	11.... [bar]	Ordering Body	Ordering Equipped B3	Ø Tube		L1	L2	L3	CH1	CH2	CH3	Ordering Equipped B4	
					D1	D2								
L	500	315	104104.1	104104	8	6	25	11	40,5	14	17	14	104104.4	
			104105.1	104105	10	6	26	12	41,5	17	19	14	104105.4	
			104106.1	104106	10	8	26	12	42	17	19	17	104106.4	
	400		104107.1	104107	12	6	27	13	42	19	22	14	104107.4	
			104108.1	104108	12	8	27	13	42,5	19	22	17	104108.4	
			104109.1	104109	12	10	28	14	43,5	19	22	19	104109.4	
			104110.1	104110	15	10	29	15	45	24	27	19	104110.4	
			104111.1	104111	15	12	29	15	44,5	24	27	22	104111.4	
			104112.1	104112	18	10	30	15,5	47	27	32	19	104112.4	
			104113.1	104113	18	12	30	15,5	46,5	27	32	22	104113.4	
			104114.1	104114	18	15	31	16,5	48	27	32	27	104114.4	
	250		160	104115.1	104115	22	12	32	17,5	48,5	32	36	22	104115.4
				104116.1	104116	22	15	33	18,5	50	32	36	27	104116.4
				104117.1	104117	22	18	33	18	51	32	36	32	104117.4
104118.1		104118		28	18	34	19	52	41	41	32	104118.4		
104119.1		104119		28	22	36	21	54	41	41	36	104119.4		
104120.1		104120		35	22	39	21	59	46	50	36	104120.4		
104121.1	104121	35		28	39	21	59	46	50	41	104121.4			
S	800	630		104122.1	104122	8	6	32	18	48	17	19	17	104122.4
				104123.1	104123	10	6	32	17,5	48,5	19	22	17	104123.4
				104124.1	104124	10	8	32	17,5	48,5	19	22	19	104124.4
	630			104125.1	104125	12	6	34	19,5	50,5	22	24	17	104125.4
				104126.1	104126	12	8	34	19,5	50,5	22	24	19	104126.4
				104127.1	104127	12	10	34	19	51	22	24	22	104127.4
				104128.1	104128	14	10	36	20,5	54,5	24	27	22	104128.4
			104129.1	104129	14	12	36	20,5	54,5	24	27	24	104129.4	
			104130.1	104130	16	12	36	20	54,5	27	30	24	104130.4	
			104131.1	104131	16	14	38	21,5	58	27	30	27	104131.4	
			104132.1	104132	20	10	40	22	59,5	32	36	22	104132.4	
	420		400	104133.1	104133	20	12	40	22	59,5	32	36	24	104133.4
				104134.1	104134	20	16	42	23	63	32	36	30	104134.4
				104135.1	104135	25	16	46	25,5	68	41	46	30	104135.4
104136.1		104136		25	20	48	25,5	71	41	46	36	104136.4		
104137.1		104137		30	20	50	26	74	46	50	36	104137.4		
104138.1		104138		30	25	52	26,5	77	46	50	46	104138.4		
315	104139.1	104139		38	30	59	29,5	87	55	60	50	104139.4		

Note: If you wish to order AISI 316 stainless steel fittings, please change the first two digits from **10....** to **11....** .
 If you wish to order AISI 316 stainless steel fittings with AISI 304 stainless steel nuts, please change the first two digits from **10....** to **14....** .
 Items not included in the ISO 8434-1 Norm available on scheduled orders only

REDUCING TEE

Type: 1045...1 Body

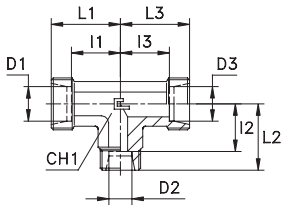

Type: 1045.. B3 Ring

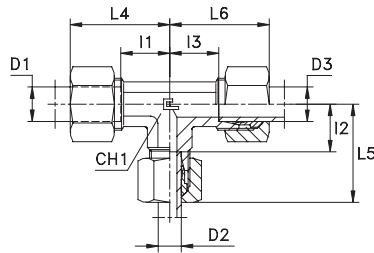

Type: 1045...4 B4 Ring

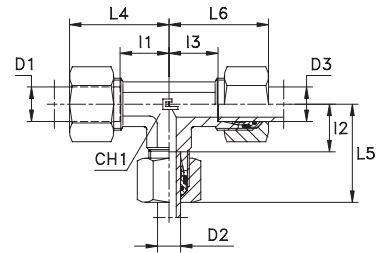

Series DIN	10.... [bar]	11.... [bar]	Ordering Body	Ordering Equipped B3	Ø Tube			L1	L2	L3	L4	L5	L6	I1	I2	I3	CH1	Ordering Equipped B4
					D1	D2	D3											
L	500		104503.1	104503	6	8	6	21	21	21	29	29	29	14	14	14	12	104503.4
			104504.1	104504	8	6	8	21	21	21	29	29	29	14	14	14	12	104504.4
			104505.1	104505	6	10	6	21	22	21	29	30	29	14	15	14	14	104505.4
			104506.1	104506	8	10	8	21	22	21	29	30	29	14	15	14	14	104506.4
			104507.1	104507	10	6	10	22	21	22	30	29	30	15	14	15	14	104507.4
			104508.1	104508	10	8	10	22	21	22	30	29	30	15	14	15	14	104508.4
	104509.1	104509	10	10	6	22	22	21	30	30	29	15	15	14	14	104509.4		
	104510.1	104510	8	12	8	23	24	23	31	32	31	16	17	16	17	104510.4		
	104511.1	104511	12	6	12	24	23	24	32	31	32	17	16	17	17	104511.4		
	104512.1	104512	12	8	8	24	23	23	32	31	31	17	16	16	17	104512.4		
	104513.1	104513	12	8	12	24	23	24	32	31	32	17	16	17	17	104513.4		
	104514.1	104514	12	10	10	24	24	24	32	32	32	17	17	17	17	104514.4		
	104515.1	104515	12	10	12	24	24	24	32	32	32	17	17	17	17	104515.4		
	104516.1	104516	12	12	10	24	24	24	32	32	32	17	17	17	17	104516.4		
	104517.1	104517	10	15	10	27	28	27	35	36	35	20	21	20	19	104517.4		
	104518.1	104518	12	15	12	27	28	27	35	36	35	20	21	20	19	104518.4		
	104519.1	104519	15	6	15	28	25	28	36	33	36	21	18	21	19	104519.4		
	104520.1	104520	15	10	15	28	27	28	36	35	36	21	20	21	19	104520.4		
	104521.1	104521	15	12	12	28	27	27	36	35	35	21	20	20	19	104521.4		
	104522.1	104522	15	12	15	28	27	28	36	35	36	21	20	21	19	104522.4		
	104523.1	104523	15	15	12	28	28	27	36	36	35	21	21	20	19	104523.4		
	104524.1	104524	12	18	12	30	31	30	38	40	38	23	23,5	23	24	104524.4		
	104525.1	104525	18	10	10	31	30	30	40	38	38	23,5	23	23,5	24	104525.4		
	104526.1	104526	18	10	18	31	30	31	40	38	40	23,5	23	23,5	24	104526.4		
	104527.1	104527	18	12	18	31	30	31	40	38	40	23,5	23	23,5	24	104527.4		
	104528.1	104528	18	15	18	31	31	31	40	39	40	23,5	24	23,5	24	104528.4		
	104529.1	104529	18	18	10	31	31	30	40	40	38	23,5	23,5	23	24	104529.4		
	104530.1	104530	22	10	22	35	33	35	44	41	44	27,5	26	27,5	27	104530.4		
	104531.1	104531	22	12	22	35	33	35	44	41	44	27,5	26	27,5	27	104531.4		
	104532.1	104532	22	15	15	35	34	34	44	42	42	27,5	27	27	27	104532.4		
104533.1	104533	22	15	22	35	34	35	44	42	44	27,5	27	27,5	27	104533.4			
104534.1	104534	22	18	18	35	34	34	44	43	43	27,5	26,5	26,5	27	104534.4			
104535.1	104535	22	18	22	35	34	35	44	43	44	27,5	26,5	27,5	27	104535.4			
104536.1	104536	22	22	18	35	35	34	44	44	43	27,5	27,5	26,5	27	104536.4			
104537.1	104537	28	10	28	38	36	38	47	44	47	30,5	29	30,5	36	104537.4			
104538.1	104538	28	12	28	38	36	38	47	44	47	30,5	29	30,5	36	104538.4			
104539.1	104539	28	15	28	38	37	38	47	45	47	30,5	30	30,5	36	104539.4			
104540.1	104540	28	18	28	38	37	38	47	46	47	30,5	29,5	30,5	36	104540.4			
104541.1	104541	28	22	22	38	38	38	47	47	47	30,5	30,5	30,5	36	104541.4			
104542.1	104542	28	22	28	38	38	38	47	47	47	30,5	30,5	30,5	36	104542.4			
104543.1	104543	10	6	10	25	25	25	34	33	34	17,5	18	17,5	17	104543.4			
104544.1	104544	12	8	8	29	25	25	38	33	33	21,5	18	18	17	104544.4			
104545.1	104545	12	8	12	29	25	29	38	33	38	21,5	18	21,5	17	104545.4			
104546.1	104546	12	10	12	29	25	29	38	34	38	21,5	17,5	21,5	17	104546.4			
104547.1	104547	12	16	12	31	33	31	40	43	40	23,5	24,5	23,5	24	104547.4			
104548.1	104548	16	6	16	33	31	33	43	39	43	24,5	24	24,5	24	104548.4			
104549.1	104549	16	8	16	33	31	33	43	39	43	24,5	24	24,5	24	104549.4			
104550.1	104550	16	10	16	33	31	33	43	40	43	24,5	23,5	24,5	24	104550.4			
104551.1	104551	16	12	16	33	31	33	43	40	43	24,5	23,5	24,5	24	104551.4			
104552.1	104552	16	20	16	36	37	36	46	48	46	27,5	26,5	27,5	27	104552.4			
104553.1	104553	20	10	20	37	34	37	48	43	48	26,5	26,5	26,5	27	104553.4			
104554.1	104554	20	12	20	37	34	37	48	43	48	26,5	26,5	26,5	27	104554.4			
104555.1	104555	20	16	20	37	36	37	48	46	48	26,5	27,5	26,5	27	104555.4			
104556.1	104556	20	25	20	40	42	40	51	54	51	29,5	30	29,5	36	104556.4			
104557.1	104557	25	16	25	42	39	42	54	49	54	30	30,5	30	36	104557.4			
104558.1	104558	25	20	25	42	40	42	54	51	54	30	29,5	30	36	104558.4			
104559.1	104559	25	30	25	47	49	47	59	62	59	35	35,5	35	41	104559.4			

Note: If you wish to order AISI 316 stainless steel fittings, please change the first two digits from 10.... to 11....
 If you wish to order AISI 316 stainless steel fittings with AISI 304 stainless steel nuts, please change the first two digits from 10.... to 14....
 Items available on request only.

BULKHEAD CONNECTION WITH ELASTOMER SEAL

Thread BSP Parallel

Type: **1049...1** Body

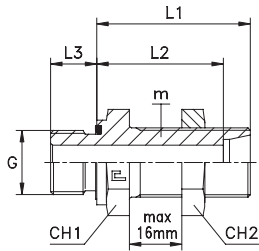

Type: **1049.. B3** Ring

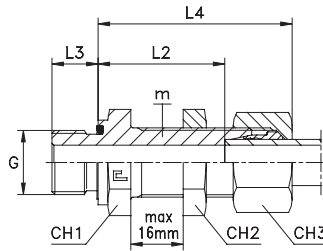

Type: **1049...4** B4 Ring

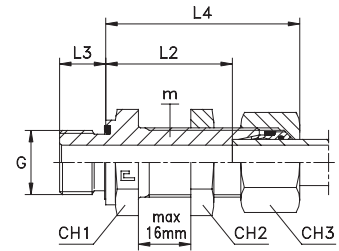

Series DIN	10.... [bar]	11.... [bar]	Ordering Body	Ordering Equipped B3	Ø Tube	m	G	L1	L2	L3	L4	CH1	CH2	CH3	Ordering Equipped B4
L	315	315	104904.1	104904	6	12x1,5	1/8	39,5	32,5	8	47,5	17	17	14	104904.4
			104905.1	104905	8	14x1,5	1/4	41	34	12	49	19	19	17	104905.4
			104906.1	104906	10	16x1,5	1/4	43	36	12	51	22	22	19	104906.4
			104907.1	104907	12	18x1,5	3/8	44,5	37,5	12	52,5	24	24	22	104907.4
			104908.1	104908	15	22x1,5	1/2	48	41	14	56	27	30	27	104908.4
	104909.1	104909	18	26x1,5	1/2	52	44,5	14	61	32	36	32	104909.4		
	160	160	104910.1	104910	22	30x2	3/4	55	47,5	16	64	36	41	36	104910.4
			104911.1	104911	28	36x2	1	58	50,5	18	67	41	46	41	104911.4
			104912.1	104912	35	45x2	1 1/4	63	52,5	20	74	50	55	50	104912.4
			104913.1	104913	42	52x2	1 1/2	64	53	22	76	60	65	60	104913.4
104914.1			104914	6	14x1,5	1/4	45	38	12	53	19	19	17	104914.4	
S	630	630	104915.1	104915	8	16x1,5	1/4	46	39	12	54	22	22	19	104915.4
			104916.1	104916	10	18x1,5	3/8	49	41,5	12	58	24	24	22	104916.4
			104917.1	104917	12	20x1,5	3/8	50	42,5	12	59	27	27	24	104917.4
			104918.1	104918	14	22x1,5	1/2	54	46	14	64	30	30	27	104918.4
	400	400	104919.1	104919	16	24x1,5	1/2	54	45,5	14	64	32	32	30	104919.4
			104920.1	104920	20	30x2	3/4	59	48,5	16	72	41	41	36	104920.4
			104921.1	104921	25	36x2	1	64	52	18	76	46	46	46	104921.4
			104922.1	104922	30	42x2	1 1/4	69	55,5	20	82	50	50	50	104922.4
	315	315	104923.1	104923	38	52x2	1 1/2	72	56	22	87	65	65	60	104923.4

Note: If you wish to order AISI 316 stainless steel fittings, please change the first two digits from **10....** to **11....** .
 If you wish to order AISI 316 stainless steel fittings with AISI 304 stainless steel nuts, please change the first two digits from **10....** to **14....** .
 Items not included in the ISO 8434-1 Norm available on request only.

WELDING BOSS

Type: **1055...1** Body

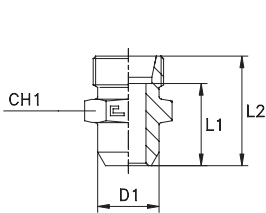

Type: **1055.. B3** Ring

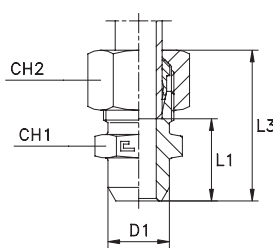

Type: **1055...4** B4 Ring

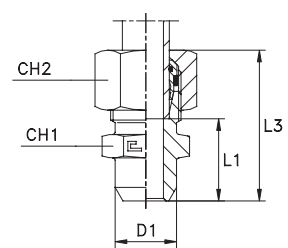

Series DIN	10.... [bar]	11.... [bar]	Ordering Body	Ordering Equipped B3	Ø Tube	D1	L1	L2	L3	CH1	CH2	Ordering Equipped B4	
L	315	315	105504.1	105504	6	10	14	21	29	12	14	105504.4	
			105505.1	105505	8	12	16	23	31	14	17	17	105505.4
			105506.1	105506	10	14	18	25	33	17	19	19	105506.4
			105507.1	105507	12	16	18	25	33	19	22	22	105507.4
			105508.1	105508	15	19	22	29	37	22	27	27	105508.4
	105509.1	105509	18	22	23,5	31	40	27	32	32	105509.4		
	160	160	105510.1	105510	22	27	28,5	36	45	32	36	36	105510.4
			105511.1	105511	28	32	30,5	38	47	41	41	41	105511.4
			105512.1	105512	35	40	32,5	43	54	46	50	50	105512.4
			105513.1	105513	42	46	35	46	58	55	60	60	105513.4
105514.1			105514	6	11	19	26	34	14	17	17	105514.4	
S	630	630	105515.1	105515	8	13	21	28	36	17	19	105515.4	
			105516.1	105516	10	15	22,5	30	39	19	22	22	105516.4
			105517.1	105517	12	17	24,5	32	41	22	24	24	105517.4
			105518.1	105518	14	19	27	35	45	24	27	27	105518.4
	400	400	105519.1	105519	16	21	26,5	35	45	27	30	30	105519.4
			105520.1	105520	20	26	29,5	40	51	32	36	36	105520.4
			105521.1	105521	25	31	32	44	56	41	46	46	105521.4
			105522.1	105522	30	36	35,5	49	62	46	50	50	105522.4
	315	315	105523.1	105523	38	44	38	54	69	55	60	105523.4	

Note: If you wish to order AISI 316 stainless steel fittings, please change the first two digits from **10....** to **11....** .
 If you wish to order AISI 316 stainless steel fittings with AISI 304 stainless steel nuts, please change the first two digits from **10....** to **14....** .

WELDING BULKHEAD CONNECTION

Type: **1056...1** Body

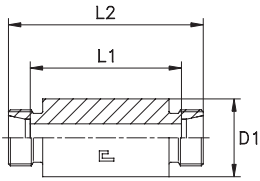

Type: **1056.. B3** Ring

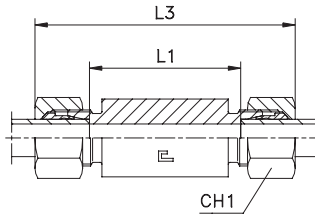

Type: **1056...4** B4 Ring

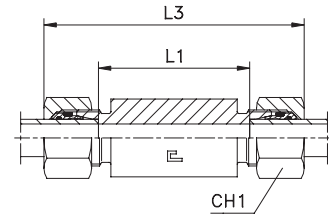

Series DIN	10.... [bar]	11.... [bar]	Ordering Body	Ordering Equipped B3	Ø Tube	D1	L1	L2	L3	CH1	Ordering Equipped B4
L	315	315	105604.1	105604	6	18	56	70	85	14	105604.4
			105605.1	105605	8	20	56	70	85	17	105605.4
			105606.1	105606	10	22	58	72	87	19	105606.4
			105607.1	105607	12	25	58	72	87	22	105607.4
			105608.1	105608	15	28	70	84	100	27	105608.4
	105609.1	105609	18	32	69	84	101	32	105609.4		
	160	160	105610.1	105610	22	36	73	88	105	36	105610.4
			105611.1	105611	28	40	73	88	106	41	105611.4
			105612.1	105612	35	50	71	92	114	50	105612.4
			105613.1	105613	42	60	70	92	115	60	105613.4
105614.1			105614	6	20	60	74	89	17	105614.4	
S	630	630	105615.1	105615	8	22	60	74	89	19	105615.4
			105616.1	105616	10	25	59	74	91	22	105616.4
			105617.1	105617	12	28	59	74	91	24	105617.4
			105618.1	105618	14	30	72	88	107	27	105618.4
			105619.1	105619	16	35	71	88	107	30	105619.4
	400	400	105620.1	105620	20	38	71	92	114	36	105620.4
			105621.1	105621	25	45	72	96	120	46	105621.4
			105622.1	105622	30	50	73	100	126	50	105622.4
			105623.1	105623	38	60	72	104	133	60	105623.4
			315	315							

Note: If you wish to order AISI 316 stainless steel fittings, please change the first two digits from **10....** to **11....** .
If you wish to order AISI 316 stainless steel fittings with AISI 304 stainless steel nuts, please change the first two digits from **10....** to **14....** .

WELDING NIPPLE WITH O-RING

Delivered separately (unassembled)

Type: **1057..**

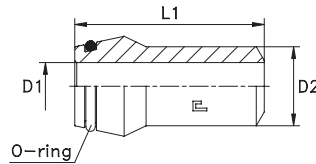

Series DIN	10.... [bar]	11.... [bar]	Ordering Complete	Thickness	Ø Tube	D1	D2	L1
L/S	630	630	105701	6x1.75	6	2.5	6	31
			105702	8x2	8	4	8	31
	315	315	105703	10x1.5	10	7	10	32.5
			105704	10x2	10	6	10	32.5
			105705	12x1.5	12	9	12	32.5
	400	400	105706	12x2	12	8	12	32.5
			105707	12x2.5	12	7	12	32.5
L	315	315	105708	15x2.5	15	10	15	34
			105709	18x2.5	18	13	18	35.5
	160	160	105710	22x2.5	22	17	22	38.5
			105711	28x2.5	28	23	28	41.5
			105712	35x3	35	29	35	47.5
			105713	42x3	42	36	42	47.5
			105714	14x3	14	8	14	38.5
S	250	250	105715	16x2	16	12	16	39
	315	315	105716	16x2.5	16	11	16	39
	400	400	105717	16x3	16	10	16	39
	250	250	105718	20x2.5	20	15	20	45
	315	315	105719	20x3	20	14	20	45
	400	400	105720	20x4	20	12	20	45
	250	250	105721	25x3	25	19	25	49.5
	315	315	105722	25x4	25	17	25	49.5
	400	315	105723	25x5	25	15	25	49.5
	160	160	105724	30x3	30	24	30	52
	250	250	105725	30x4	30	22	30	52
	315	315	105726	30x5	30	20	30	52
			105727	30x6	30	18	30	52
			105728	38x3	38	32	38	56.5
	250	250	105729	38x5	38	28	38	56.5
315	315	105730	38x6	38	26	38	56.5	
		105731	38x8	38	22	38	56.5	

Note: If you wish to order a fitting in stainless steel, please change the first two digit from **10....** to **11....** .

WELDING ELBOW

Type: **1058...1** Body

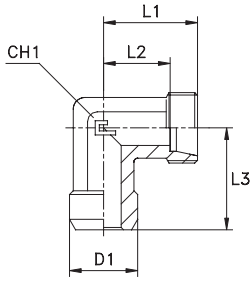

Type: **1058.. B3** Ring

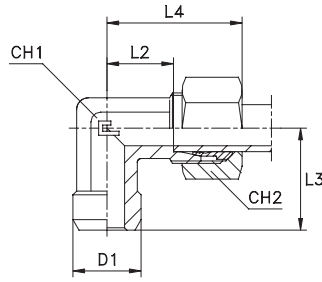

Type: **1058...4** B4 Ring

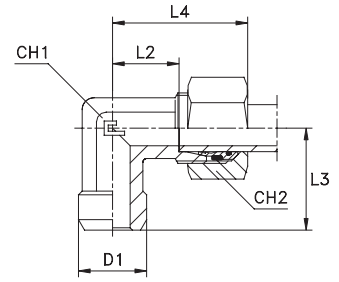

Series DIN	10.... [bar]	11.... [bar]	Ordering Body	Ordering Equipped B3	Ø Tube	D1	L1	L2	L3	L4	CH1	CH2	Ordering Equipped B4
L	315	315	105804.1	105804	6	10	19	12	19	27	12	14	105804.4
			105805.1	105805	8	12	21	14	21	29	12	17	105805.4
			105806.1	105806	10	14	22	15	22	30	14	19	105806.4
			105807.1	105807	12	16	24	17	24	32	17	22	105807.4
			105808.1	105808	15	19	28	21	28	36	19	27	105808.4
			105809.1	105809	18	22	31	23,5	31	40	24	32	105809.4
	160	160	105810.1	105810	22	27	35	27,5	35	44	27	36	105810.4
			105811.1	105811	28	32	38	30,5	38	47	36	41	105811.4
			105812.1	105812	35	40	45	34,5	45	56	41	50	105812.4
			105813.1	105813	42	46	51	40	51	63	50	60	105813.4
S	630	630	105814.1	105814	6	11	23	16	23	31	12	17	105814.4
			105815.1	105815	8	13	24	17	24	32	14	19	105815.4
			105816.1	105816	10	15	25	17,5	25	34	17	22	105816.4
			105817.1	105817	12	17	29	21,5	29	38	17	24	105817.4
			105818.1	105818	14	19	30	22	30	40	19	27	105818.4
			105819.1	105819	16	21	33	24,5	33	43	24	30	105819.4
	400	400	105820.1	105820	20	26	37	26,5	37	48	27	36	105820.4
			105821.1	105821	25	31	42	30	42	54	36	46	105821.4
			105822.1	105822	30	36	49	35,5	49	62	41	50	105822.4
			105823.1	105823	38	44	57	41	57	72	50	60	105823.4
	315	315											

Note: If you wish to order AISI 316 stainless steel fittings, please change the first two digits from **10....** to **11....** .
If you wish to order AISI 316 stainless steel fittings with AISI 304 stainless steel nuts, please change the first two digits from **10....** to **14....** .
Items not included in the ISO 8434-1 Norm available on request only.

GAUGE COUPLING

Thread BSP Parallel

Type: **1059...1** Body
Metal washer seal

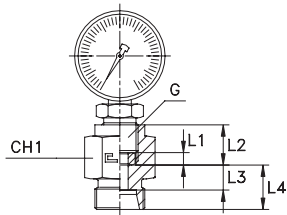

Type: **1059.. B3** Ring
Metal washer seal

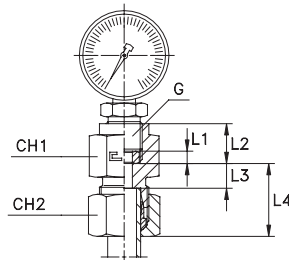

Type: **1059...4** B4 Ring
O-ring washer seal

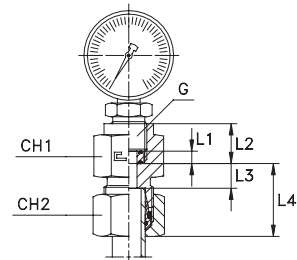

Series DIN	10.... [bar]	11.... [bar]	Ordering Body + Ferrule	Ordering Equipped B3	Ø Tube	G	L1	L2	L3	L4	CH1	CH2	Ordering Equipped B4
L	315	315	105904.1	105904	6	1/4	4,5	14,5	7,5	14,5	19	14	105904.4
			105905.1	105905	8	1/4	4,5	14,5	7,5	14,5	19	17	105905.4
			105906.1	105906	10	1/4	4,5	14,5	8,5	15,5	19	19	105906.4
			105907.1	105907	12	1/4	4,5	14,5	8,5	15,5	19	22	105907.4
			105914.1	105914	6	1/2	5	20	11	18	30	17	105914.4
S	630	630	105915.1	105915	8	1/2	5	20	11	18	30	19	105915.4
			105916.1	105916	10	1/2	5	20	10,5	18	30	22	105916.4
			105917.1	105917	12	1/2	5	20	10,5	18	30	24	105917.4

Note: If you wish to order AISI 316 stainless steel fittings, please change the first two digits from **10....** to **11....** .
If you wish to order AISI 316 stainless steel fittings with AISI 304 stainless steel nuts, please change the first two digits from **10....** to **14....** .
Items not included in the ISO 8434-1 Norm.
Gauge not included.

ADJUSTABLE DIN MALE STUD ELBOW WITH O-RING AND WASHER

Thread BSP Parallel - Thread Metric Parallel

Type: **1061...1** Body
Type: **1062...1** Body

Type: **1061.. B3** Ring
Type: **1062.. B3** Ring

Type: **1061...4** B4 Ring
Type: **1062...4** B4 Ring

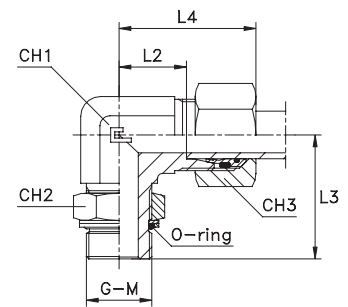
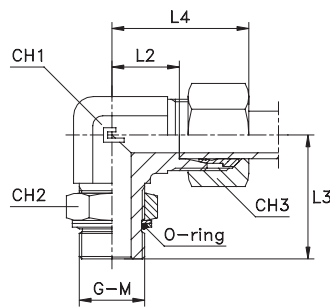
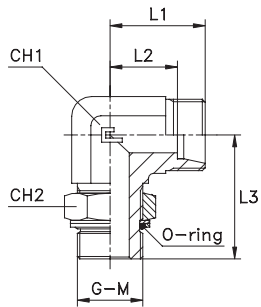

Series DIN	10.... [bar]	11.... [bar]	Ordering Body	Ordering Equipped B3	Ø Tube	G	L1	L2	L3	L4	CH1	CH2	CH3	Ordering Equipped B4
L	315	315	106104.1	106104	6	1/8	19	12	26	27	11	14	14	106104.4
			106105.1	106105	8	1/4	21	14	32	29	14	19	17	106105.4
			106106.1	106106	10	1/4	22	15	32	30	14	19	19	106106.4
	250	250	106107.1	106107	12	3/8	24	17	37	32	19	22	22	106107.4
			106108.1	106108	15	1/2	28	21	44	36	22	27	27	106108.4
			106109.1	106109	18	1/2	31	23,5	47	40	27	27	32	106109.4
	160	160	106110.1	106110	22	3/4	35	27,5	51	44	27	36	36	106110.4
			106111.1	106111	28	1	38	30,5	53	47	33	41	41	106111.4
			106112.1	106112	35	1 1/4	45	34,5	59	56	41	50	50	106112.4
S	315	315	106113.1	106113	42	1 1/2	51	40	64	63	48	55	60	106113.4
			106114.1	106114	6	1/4	23	16	32	31	14	19	17	106114.4
			106115.1	106115	8	1/4	24	17	32	32	14	19	19	106115.4
	250	250	106116.1	106116	10	3/8	25	17,5	37	34	19	22	22	106116.4
			106117.1	106117	12	3/8	29	21,5	37	38	19	22	24	106117.4
			106118.1	106118	14	1/2	30	22	44	40	22	27	27	106118.4
			106119.1	106119	16	1/2	33	24,5	47	43	27	27	30	106119.4
	200	200	106120.1	106120	20	3/4	37	26,5	51	48	27	36	36	106120.4
			106121.1	106121	25	1	42	30	53	54	33	41	46	106121.4
160	160	106122.1	106122	30	1 1/4	49	35,5	59	62	41	50	50	106122.4	
		106123.1	106123	38	1 1/2	57	41	64	72	48	55	60	106123.4	

Note: If you wish to order AISI 316 stainless steel fittings, please change the first two digits from **10....** to **11....** .
If you wish to order AISI 316 stainless steel fittings with AISI 304 stainless steel nuts, please change the first two digits from **10....** to **14....** .
Items not included in the ISO 8434-1 Norm available on request only.

Series DIN	10.... [bar]	11.... [bar]	Ordering Body	Ordering Equipped B3	Ø Tube	M	L1	L2	L3	L4	CH1	CH2	CH3	Ordering Equipped B4
L	315	315	106204.1	106204	6	10x1	19	12	27	27	11	14	14	106204.4
			106205.1	106205	8	12x1,5	21	14	31	29	14	17	17	106205.4
			106206.1	106206	10	14x1,5	22	15	33	30	14	19	19	106206.4
			106207.1	106207	12	16x1,5	24	17	38	32	19	22	22	106207.4
			106208.1	106208	15	18x1,5	28	21	40	36	22	24	27	106208.4
	250	250	106209.1	106209	18	22x1,5	31	23,5	46	40	27	27	32	106209.4
			106210.1	106210	22	27x2	35	27,5	50,5	44	27	32	36	106210.4
			106211.1	106211	28	33x2	38	30,5	52,5	47	33	41	41	106211.4
			106212.1	106212	35	42x2	45	34,5	58	56	41	50	50	106212.4
S	160	160	106213.1	106213	42	48x2	51	40	63	63	48	55	60	106213.4
			106214.1	106214	6	12x1,5	23	16	31	31	14	17	17	106214.4
			106215.1	106215	8	14x1,5	24	17	33	32	14	19	19	106215.4
			106216.1	106216	10	16x1,5	25	17,5	38	34	19	22	22	106216.4
	250	250	106217.1	106217	12	18x1,5	29	21,5	38	38	19	24	24	106217.4
			106218.1	106218	14	20x1,5	30	22	44	40	22	27	27	106218.4
			106219.1	106219	16	22x1,5	33	24,5	48	43	27	27	30	106219.4
	200	200	106220.1	106220	20	27x2	37	26,5	50,5	48	27	32	36	106220.4
			106221.1	106221	25	33x2	42	30	52,5	54	33	41	46	106221.4
160	160	106222.1	106222	30	42x2	49	35,5	58	62	41	50	50	106222.4	
		106223.1	106223	38	48x2	57	41	63	72	48	55	60	106223.4	

Note: If you wish to order AISI 316 stainless steel fittings, please change the first two digits from **10....** to **11....** .
If you wish to order AISI 316 stainless steel fittings with AISI 304 stainless steel nuts, please change the first two digits from **10....** to **14....** .
Items not included in the ISO 8434-1 Norm available on request only.

ADJUSTABLE DIN MALE STUD ELBOW WITH O-RING

Thread UNF/UN-2A

Type: **1063...1** Body

Type: **1063..** B3 Ring

Type: **1063...4** B4 Ring

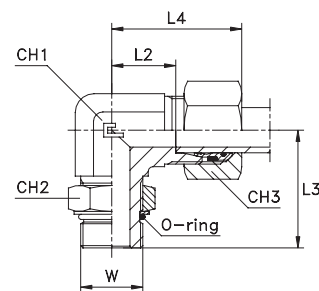
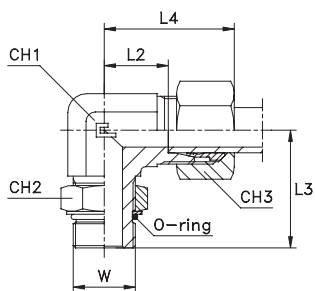
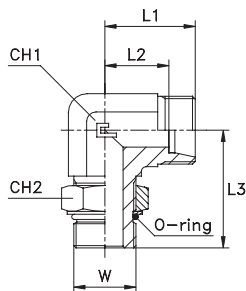

Series DIN	10.... [bar]	11.... [bar]	Ordering Body	Ordering Equipped B3	Ø Tube	W	L1	L2	L3	L4	CH1	CH2	CH3	Ordering Equipped B4
L	315	315	106304.1	106304	6	7/16-20	19	12	27	27	11	14	14	106304.4
			106305.1	106305	8	7/16-20	21	14	28	29	14	14	17	106305.4
			106306.1	106306	10	9/16-18	22	15	32	30	14	17	19	106306.4
			106307.1	106307	12	3/4-16	24	17	37	32	19	22	22	106307.4
			106308.1	106308	15	7/8-14	28	21	43	36	22	27	27	106308.4
	106309.1	106309	18	7/8-14	31	23.5	47	40	27	27	32	106309.4		
	160	160	106310.1	106310	22	1 1/16-12	35	27.5	49.5	44	27	32	36	106310.4
			106311.1	106311	28	1 5/16-12	38	30.5	52	47	33	41	41	106311.4
			106312.1	106312	35	1 5/8-12	45	34.5	58	56	41	50	50	106312.4
			106313.1	106313	42	1 7/8-12	51	40	60	63	48	55	60	106313.4
106314.1			106314	6	7/16-20	23	16	29	31	14	14	17	106314.4	
S	400	400	106315.1	106315	8	9/16-18	24	17	33	32	14	17	19	106315.4
			106316.1	106316	10	9/16-18	25	17.5	37.5	34	19	17	22	106316.4
			106317.1	106317	12	3/4-16	29	21.5	38	38	19	22	24	106317.4
			106318.1	106318	14	7/8-14	30	22	44	40	22	27	27	106318.4
			106319.1	106319	16	7/8-14	33	24.5	48	43	27	27	30	106319.4
	106320.1	106320	20	1 1/16-12	37	26.5	51	48	27	32	36	106320.4		
	106321.1	106321	25	1 5/16-12	42	30	53	54	33	41	46	106321.4		
	250	250	106322.1	106322	30	1 5/8-12	49	35.5	59	62	41	50	50	106322.4
			106323.1	106323	38	1 7/8-12	57	41	62	72	48	55	60	106323.4

Note: If you wish to order AISI 316 stainless steel fittings, please change the first two digits from **10....** to **11....** .
 If you wish to order AISI 316 stainless steel fittings with AISI 304 stainless steel nuts, please change the first two digits from **10....** to **14....** .
 Items not included in the ISO 8434-1 Norm available on request only.

ADJUSTABLE DIN MALE 45° STUD ELBOW WITH O-RING AND WASHER

Thread BSP Parallel

Type: **1064...1** Body

Type: **1064..** B3 Ring

Type: **1064...4** B4 Ring

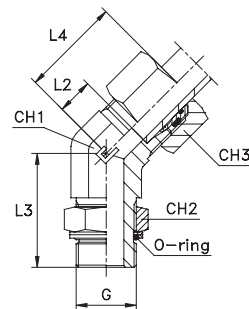
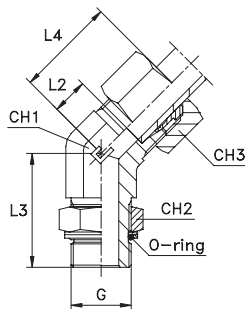
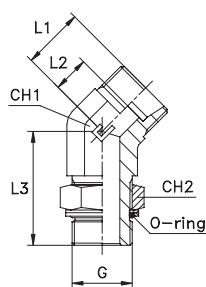

Series DIN	10.... [bar]	11.... [bar]	Ordering Body	Ordering Equipped B3	Ø Tube	G	L1	L2	L3	L4	CH1	CH2	CH3	Ordering Equipped B4
L	315	315	106404.1	106404	6	1/8	16	9	26	24	11	14	14	106404.4
			106405.1	106405	8	1/4	19	12	29	27	14	19	17	106405.4
			106406.1	106406	10	1/4	19	12	29	27	14	19	19	106406.4
			106407.1	106407	12	3/8	21	14	33	29	19	22	22	106407.4
			106408.1	106408	15	1/2	24	17	38.5	32	27	27	27	106408.4
	106409.1	106409	18	1/2	24.5	17	38.5	33.5	27	27	32	106409.4		
	160	160	106410.1	106410	22	3/4	26	18.5	44	35	27	36	36	106410.4
			106411.1	106411	28	1	30.5	23	47	39.5	33	41	41	106411.4
			106412.1	106412	35	1 1/4	33	22.5	48	44	41	50	50	106412.4
			106413.1	106413	42	1 1/2	37	26	48	49	48	55	60	106413.4
106414.1			106414	6	1/4	16	9	29	24	14	19	17	106414.4	
S	315	315	106415.1	106415	8	1/4	19	12	29	27	14	19	19	106415.4
			106416.1	106416	10	3/8	20	12.5	33	29	19	22	22	106416.4
			106417.1	106417	12	3/8	21	13.5	33	30	19	22	24	106417.4
			106418.1	106418	14	1/2	24	16	38.5	34	22	27	27	106418.4
			106419.1	106419	16	1/2	24	15.5	38.5	34	27	27	30	106419.4
	106420.1	106420	20	3/4	26.5	16	44	37.5	27	36	36	106420.4		
	200	200	106421.1	106421	25	1	31	19	47	43	33	41	46	106421.4
			106422.1	106422	30	1 1/4	35	21.5	48	48	41	50	50	106422.4
			106423.1	106423	38	1 1/2	39	23	48	54	48	55	60	106423.4

Note: If you wish to order AISI 316 stainless steel fittings, please change the first two digits from **10....** to **11....** .
 If you wish to order AISI 316 stainless steel fittings with AISI 304 stainless steel nuts, please change the first two digits from **10....** to **14....** .
 Items not included in the ISO 8434-1 Norm available on request only.

ADJUSTABLE DIN MALE 45° STUD ELBOW WITH O-RING AND WASHER

Thread Metric Parallel

Type: **1065...1** Body

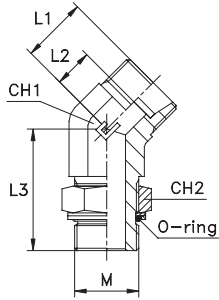

Type: **1065.. B3 Ring**

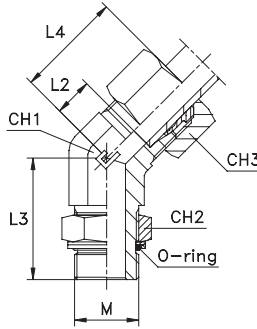

Type: **1065...4 B4 Ring**

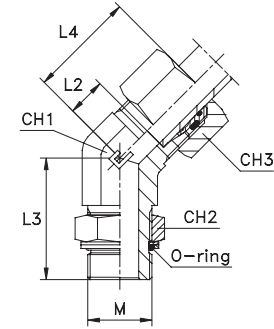

Series DIN	10.... [bar]	11.... [bar]	Ordering Body	Ordering Equipped B3	Ø Tube	M	L1	L2	L3	L4	CH1	CH2	CH3	Ordering Equipped B4
L	315	315	106504.1	106504	6	10x1	16	9	27	24	11	14	14	106504.4
			106505.1	106505	8	12x1.5	19	12	27	27	14	17	17	106505.4
			106506.1	106506	10	14x1.5	19	12	28	27	14	19	19	106506.4
			106507.1	106507	12	16x1.5	21	14	33	29	19	22	22	106507.4
			106508.1	106508	15	18x1.5	24	17	36	32	22	24	27	106508.4
	250	250	106509.1	106509	18	22x1.5	24.5	17	38	33.5	27	27	32	106509.4
			106510.1	106510	22	27x2	26	18.5	46	35	27	32	36	106510.4
			106511.1	106511	28	33x2	30.5	23	46	39.5	33	41	41	106511.4
			106512.1	106512	35	42x2	33	22.5	48	44	41	50	50	106512.4
			106513.1	106513	42	48x2	37	26	50	49	48	55	60	106513.4
S	315	315	106514.1	106514	6	12x1.5	16	9	27	24	14	17	17	106514.4
			106515.1	106515	8	14x1.5	19	12	28	27	14	19	19	106515.4
			106516.1	106516	10	16x1.5	20	12.5	33	29	19	22	22	106516.4
			106517.1	106517	12	18x1.5	21	13.5	33	30	19	24	24	106517.4
			106518.1	106518	14	20x1.5	24	16	39	34	22	27	27	106518.4
	250	250	106519.1	106519	16	22x1.5	24	15.5	40	34	27	27	30	106519.4
			106520.1	106520	20	27x2	26.5	16	46	37.5	27	32	36	106520.4
			106521.1	106521	25	33x2	31	19	46	43	33	41	46	106521.4
			106522.1	106522	30	42x2	35	21.5	48	48	41	50	50	106522.4
			106523.1	106523	38	48x2	39	23	50	54	48	55	60	106523.4

Note: If you wish to order AISI 316 stainless steel fittings, please change the first two digits from **10....** to **11....** .
 If you wish to order AISI 316 stainless steel fittings with AISI 304 stainless steel nuts, please change the first two digits from **10....** to **14....** .
 Items not included in the ISO 8434-1 Norm available on request only.

ADJUSTABLE DIN MALE 45° STUD ELBOW WITH O-RING

Thread UNF/UN-2A

Type: **1066...1** Body

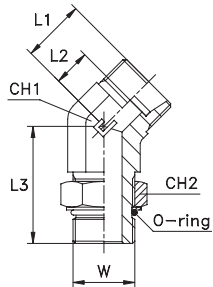

Type: **1066.. B3 Ring**

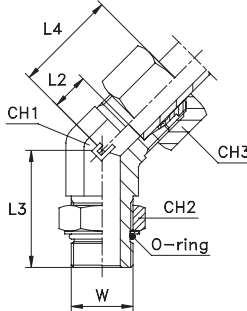

Type: **1066...4 B4 Ring**

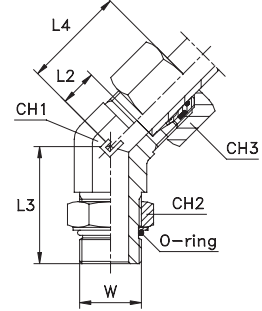

Series DIN	10.... [bar]	11.... [bar]	Ordering Body	Ordering Equipped B3	Ø Tube	W	L1	L2	L3	L4	CH1	CH2	CH3	Ordering Equipped B4
L	315	315	106604.1	106604	6	7/16-20	16	9	26.5	24	11	14	14	106604.4
			106605.1	106605	8	7/16-20	19	12	26.5	27	14	14	17	106605.4
			106606.1	106606	10	9/16-18	19	12	29	27	14	17	19	106606.4
			106607.1	106607	12	3/4-16	21	14	33	29	19	22	22	106607.4
			106608.1	106608	15	7/8-14	24	17	39	32	22	27	27	106608.4
	160	160	106609.1	106609	18	7/8-14	24.5	17	39	33.5	27	27	32	106609.4
			106610.1	106610	22	1 1/16-12	26	18.5	44	35	27	32	36	106610.4
			106611.1	106611	28	1 5/16-12	30.5	23	47	39.5	33	41	41	106611.4
			106612.1	106612	35	1 5/8-12	33	22.5	48	44	41	50	50	106612.4
			106613.1	106613	42	1 7/8-12	37	26	48.5	49	48	55	60	106613.4
S	400	400	106614.1	106614	6	7/16-20	16	9	27	24	14	14	17	106614.4
			106615.1	106615	8	9/16-18	19	12	30	27	14	17	19	106615.4
			106616.1	106616	10	9/16-18	20	12.5	34	29	19	17	22	106616.4
			106617.1	106617	12	3/4-16	21	13.5	34	30	19	22	24	106617.4
			106618.1	106618	14	7/8-14	24	16	39	34	22	27	27	106618.4
	315	315	106619.1	106619	16	7/8-14	24	15.5	39	34	27	27	30	106619.4
			106620.1	106620	20	1 1/16-12	26.5	16	44	37.5	27	32	36	106620.4
			106621.1	106621	25	1 5/16-12	31	19	47	43	33	41	46	106621.4
			106622.1	106622	30	1 5/8-12	35	21.5	48	48	41	50	50	106622.4
			106623.1	106623	38	1 7/8-12	39	23	50	54	48	55	60	106623.4

Note: If you wish to order AISI 316 stainless steel fittings, please change the first two digits from **10....** to **11....** .
 If you wish to order AISI 316 stainless steel fittings with AISI 304 stainless steel nuts, please change the first two digits from **10....** to **14....** .
 Items not included in the ISO 8434-1 Norm available on request only.

ADJUSTABLE DIN MALE STUD BARREL TEE WITH O-RING AND WASHER

Thread BSP Parallel - Thread Metric Parallel

Type: **1067...1** Body
Type: **1068...1** Body

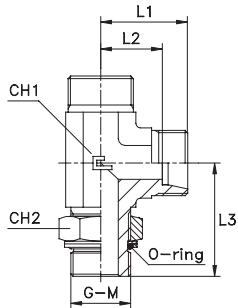

Type: **1067.. B3** Ring
Type: **1068.. B3** Ring

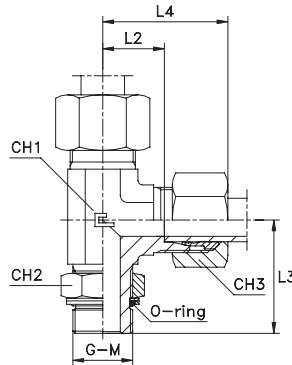

Type: **1067...4** B4 Ring
Type: **1068...4** B4 Ring

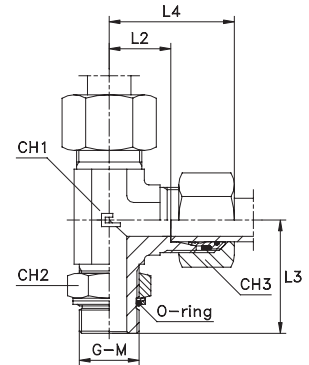

Series DIN	10.... [bar]	11.... [bar]	Ordering Body	Ordering Equipped B3	Ø Tube	G	L1	L2	L3	L4	CH1	CH2	CH3	Ordering Equipped B4	
L	315	315	106704.1	106704	6	1/8	19	12	26	27	11	14	14	106704.4	
			106705.1	106705	8	1/4	21	14	32	29	14	19	17	106705.4	
			106706.1	106706	10	1/4	22	15	32	30	14	19	19	106706.4	
	250	250	106707.1	106707	12	3/8	24	17	37	32	19	22	22	106707.4	
			106708.1	106708	15	1/2	28	21	44	36	22	27	27	106708.4	
			106709.1	106709	18	1/2	31	23,5	47	40	27	27	32	106709.4	
	160	160	106710.1	106710	22	3/4	35	27,5	51	44	27	36	36	106710.4	
			106711.1	106711	28	1	38	30,5	53	47	33	41	41	106711.4	
			106712.1	106712	35	1 1/4	45	34,5	59	56	41	50	50	106712.4	
	S	315	315	106713.1	106713	42	1 1/2	51	40	64	63	48	55	60	106713.4
				106714.1	106714	6	1/4	23	16	32	31	14	19	17	106714.4
				106715.1	106715	8	1/4	24	17	32	32	14	19	19	106715.4
250		250	106716.1	106716	10	3/8	25	17,5	37	34	19	22	22	106716.4	
			106717.1	106717	12	3/8	29	21,5	37	38	19	22	24	106717.4	
			106718.1	106718	14	1/2	30	22	44	40	22	27	27	106718.4	
			106719.1	106719	16	1/2	33	24,5	47	43	27	27	30	106719.4	
			106720.1	106720	20	3/4	37	26,5	51	48	27	36	36	106720.4	
200		200	106721.1	106721	25	1	42	30	53	54	33	41	46	106721.4	
			106722.1	106722	30	1 1/4	49	35,5	59	62	41	50	50	106722.4	
160		160	106723.1	106723	38	1 1/2	57	41	64	72	48	55	60	106723.4	

Note: If you wish to order AISI 316 stainless steel fittings, please change the first two digits from **10....** to **11....** .
If you wish to order AISI 316 stainless steel fittings with AISI 304 stainless steel nuts, please change the first two digits from **10....** to **14....** .
Items not included in the ISO 8434-1 Norm available on request only.

Series DIN	10.... [bar]	11.... [bar]	Ordering Body	Ordering Equipped B3	Ø Tube	M	L1	L2	L3	L4	CH1	CH2	CH3	Ordering Equipped B4
L	315	315	106804.1	106804	6	10x1	19	12	27	27	11	14	14	106804.4
			106805.1	106805	8	12x1,5	21	14	31	29	14	17	17	106805.4
			106806.1	106806	10	14x1,5	22	15	33	30	14	19	19	106806.4
			106807.1	106807	12	16x1,5	24	17	38	32	19	22	22	106807.4
			106808.1	106808	15	18x1,5	28	21	40	36	22	24	27	106808.4
	250	250	106809.1	106809	18	22x1,5	31	23,5	46	40	27	27	32	106809.4
			106810.1	106810	22	27x2	35	27,5	50,5	44	27	32	36	106810.4
			106811.1	106811	28	33x2	38	30,5	52,5	47	33	41	41	106811.4
	160	160	106812.1	106812	35	42x2	45	34,5	58	56	41	50	50	106812.4
			106813.1	106813	42	48x2	51	40	63	63	48	55	60	106813.4
			106814.1	106814	6	12x1,5	23	16	31	31	14	17	17	106814.4
	S	315	315	106815.1	106815	8	14x1,5	24	17	33	32	14	19	19
106816.1				106816	10	16x1,5	25	17,5	38	34	19	22	22	106816.4
106817.1				106817	12	18x1,5	29	21,5	38	38	19	24	24	106817.4
106818.1				106818	14	20x1,5	30	22	44	40	22	27	27	106818.4
250		250	106819.1	106819	16	22x1,5	33	24,5	48	43	27	27	30	106819.4
			106820.1	106820	20	27x2	37	26,5	50,5	48	27	32	36	106820.4
			106821.1	106821	25	33x2	42	30	52,5	54	33	41	46	106821.4
200		200	106822.1	106822	30	42x2	49	35,5	58	62	41	50	50	106822.4
			106823.1	106823	38	48x2	57	41	63	72	48	55	60	106823.4

Note: If you wish to order AISI 316 stainless steel fittings, please change the first two digits from **10....** to **11....** .
If you wish to order AISI 316 stainless steel fittings with AISI 304 stainless steel nuts, please change the first two digits from **10....** to **14....** .
Items not included in the ISO 8434-1 Norm available on request only.

ADJUSTABLE DIN MALE STUD BARREL TEE WITH O-RING

Thread UNF/UN-2A

Type: **1069...1** Body

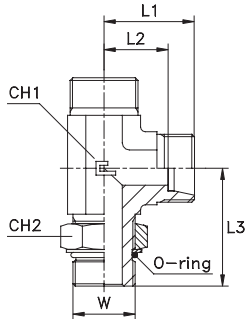

Type: **1069.. B3** Ring

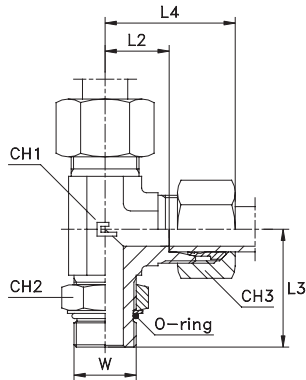

Type: **1069...4** B4 Ring

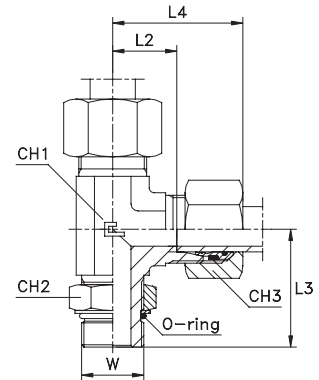

Series DIN	10.... [bar]	11.... [bar]	Ordering Body	Ordering Equipped B3	Ø Tube	W	L1	L2	L3	L4	CH1	CH2	CH3	Ordering Equipped B4
L	315	315	106904.1	106904	6	7/16-20	19	12	27	27	11	14	14	106904.4
			106905.1	106905	8	7/16-20	21	14	28	29	14	14	17	106905.4
			106906.1	106906	10	9/16-18	22	15	32	30	14	17	19	106906.4
			106907.1	106907	12	3/4-16	24	17	37	32	19	22	22	106907.4
			106908.1	106908	15	7/8-14	28	21	43	36	22	27	27	106908.4
	106909.1	106909	18	7/8-14	31	23,5	47	40	27	27	32	106909.4		
	160	160	106910.1	106910	22	1 1/16-12	35	27,5	49,5	44	27	32	36	106910.4
			106911.1	106911	28	1 5/16-12	38	30,5	52	47	33	41	41	106911.4
			106912.1	106912	35	1 5/8-12	45	34,5	58	56	41	50	50	106912.4
			106913.1	106913	42	1 7/8-12	51	40	60	63	48	55	60	106913.4
106914.1			106914	6	7/16-20	23	16	29	31	14	14	17	106914.4	
S	400	400	106915.1	106915	8	9/16-18	24	17	33	32	14	17	19	106915.4
			106916.1	106916	10	9/16-18	25	17,5	37,5	34	19	17	22	106916.4
			106917.1	106917	12	3/4-16	29	21,5	38	38	19	22	24	106917.4
			106918.1	106918	14	7/8-14	30	22	44	40	22	27	27	106918.4
			106919.1	106919	16	7/8-14	33	24,5	48	43	27	27	30	106919.4
			106920.1	106920	20	1 1/16-12	37	26,5	51	48	27	32	36	106920.4
			106921.1	106921	25	1 5/16-12	42	30	53	54	33	41	46	106921.4
	250	250	106922.1	106922	30	1 5/8-12	49	35,5	59	62	41	50	50	106922.4
			106923.1	106923	38	1 7/8-12	57	41	62	72	48	55	60	106923.4

Note: If you wish to order AISI 316 stainless steel fittings, please change the first two digits from **10....** to **11....** .
 If you wish to order AISI 316 stainless steel fittings with AISI 304 stainless steel nuts, please change the first two digits from **10....** to **14....** .
 Items not included in the ISO 8434-1 Norm available on request only.

JUSTABLE DIN MALE STUD BRANCH TEE WITH O-RING AND WASHER

Thread BSP Parallel - Thread Metric Parallel

Type: **1070...1** Body
Type: **1071...1** Body

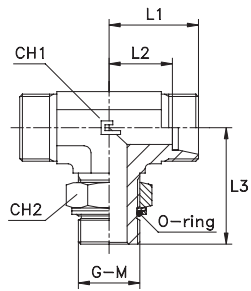

Type: **1070.. B3** Ring
Type: **1071.. B3** Ring

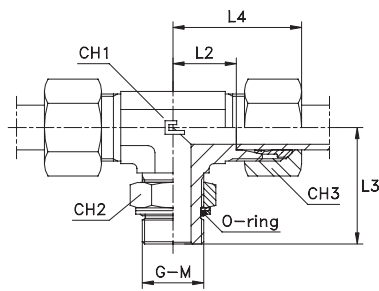

Type: **1070...4 B4** Ring
Type: **1071...4 B4** Ring

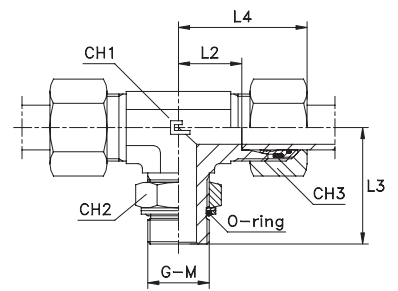

Series DIN	10.... [bar]	11.... [bar]	Ordering Body	Ordering Equipped B3	Ø Tube	G	L1	L2	L3	L4	CH1	CH2	CH3	Ordering Equipped B4	
L	315	315	107004.1	107004	6	1/8	19	12	26	27	11	14	14	107004.4	
			107005.1	107005	8	1/4	21	14	32	29	14	19	17	107005.4	
			107006.1	107006	10	1/4	22	15	32	30	14	19	19	107006.4	
	250	250	107007.1	107007	12	3/8	24	17	37	32	19	22	22	107007.4	
			107008.1	107008	15	1/2	28	21	44	36	22	27	27	107008.4	
			107009.1	107009	18	1/2	31	23,5	47	40	27	27	32	107009.4	
	160	160	107010.1	107010	22	3/4	35	27,5	51	44	27	36	36	107010.4	
			107011.1	107011	28	1	38	30,5	53	47	33	41	41	107011.4	
			107012.1	107012	35	1 1/4	45	34,5	59	56	41	50	50	107012.4	
			107013.1	107013	42	1 1/2	51	40	64	63	48	55	60	107013.4	
S	315	315	107014.1	107014	6	1/4	23	16	32	31	14	19	17	107014.4	
			107015.1	107015	8	1/4	24	17	32	32	14	19	19	107015.4	
	250	250	107016.1	107016	10	3/8	25	17,5	37	34	19	22	22	107016.4	
			107017.1	107017	12	3/8	29	21,5	37	38	19	22	24	107017.4	
			107018.1	107018	14	1/2	30	22	44	40	22	27	27	107018.4	
			107019.1	107019	16	1/2	33	24,5	47	43	27	27	30	107019.4	
				107020.1	107020	20	3/4	37	26,5	51	48	27	36	36	107020.4
	200	200	107021.1	107021	25	1	42	30	53	54	33	41	46	107021.4	
			107022.1	107022	30	1 1/4	49	35,5	59	62	41	50	50	107022.4	
	160	160	107023.1	107023	38	1 1/2	57	41	64	72	48	55	60	107023.4	

Note: If you wish to order AISI 316 stainless steel fittings, please change the first two digits from **10....** to **11....** .
If you wish to order AISI 316 stainless steel fittings with AISI 304 stainless steel nuts, please change the first two digits from **10....** to **14....** .
Items not included in the ISO 8434-1 Norm available on request only.

Series DIN	10.... [bar]	11.... [bar]	Ordering Body	Ordering Equipped B3	Ø Tube	M	L1	L2	L3	L4	CH1	CH2	CH3	Ordering Equipped B4	
L	315	315	107104.1	107104	6	10x1	19	12	27	27	11	14	14	107104.4	
			107105.1	107105	8	12x1,5	21	14	31	29	14	17	17	107105.4	
			107106.1	107106	10	14x1,5	22	15	33	30	14	19	19	107106.4	
			107107.1	107107	12	16x1,5	24	17	38	32	19	22	22	107107.4	
			107108.1	107108	15	18x1,5	28	21	40	36	22	24	27	107108.4	
	250	250	107109.1	107109	18	22x1,5	31	23,5	46	40	27	27	32	107109.4	
	160	160	107110.1	107110	22	27x2	35	27,5	50,5	44	27	32	36	107110.4	
			107111.1	107111	28	33x2	38	30,5	52,5	47	33	41	41	107111.4	
			107112.1	107112	35	42x2	45	34,5	58	56	41	50	50	107112.4	
107113.1			107113	42	48x2	51	40	63	63	48	55	60	107113.4		
S	315	315	107114.1	107114	6	12x1,5	23	16	31	31	14	17	17	107114.4	
			107115.1	107115	8	14x1,5	24	17	33	32	14	19	19	107115.4	
			107116.1	107116	10	16x1,5	25	17,5	38	34	19	22	22	107116.4	
			107117.1	107117	12	18x1,5	29	21,5	38	38	19	24	24	107117.4	
	250	250	107118.1	107118	14	20x1,5	30	22	44	40	22	27	27	107118.4	
			107119.1	107119	16	22x1,5	33	24,5	48	43	27	27	30	107119.4	
				107120.1	107120	20	27x2	37	26,5	50,5	48	27	32	36	107120.4
	200	200	107121.1	107121	25	33x2	42	30	52,5	54	33	41	46	107121.4	
			107122.1	107122	30	42x2	49	35,5	58	62	41	50	50	107122.4	
	160	160	107123.1	107123	38	48x2	57	41	63	72	48	55	60	107123.4	

Note: If you wish to order AISI 316 stainless steel fittings, please change the first two digits from **10....** to **11....** .
If you wish to order AISI 316 stainless steel fittings with AISI 304 stainless steel nuts, please change the first two digits from **10....** to **14....** .
Items not included in the ISO 8434-1 Norm available on request only.

ADJUSTABLE DIN MALE STUD BRANCH TEE WITH O-RING

Thread UNF/UN-2A

Type: **1072...1** Body

Type: **1072... B3** Ring

Type: **1072...4** B4 Ring

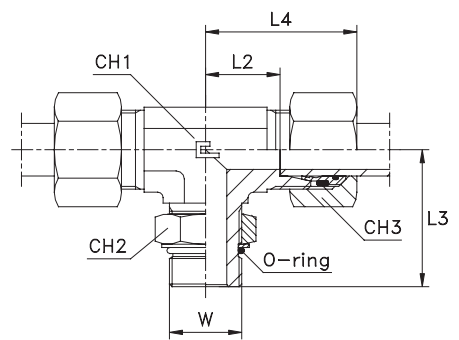
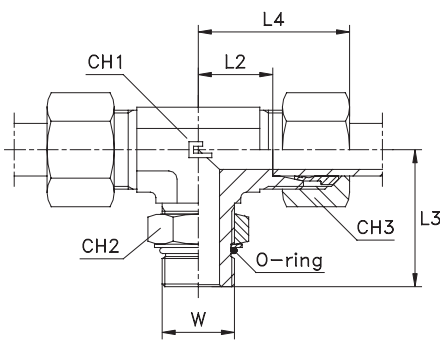
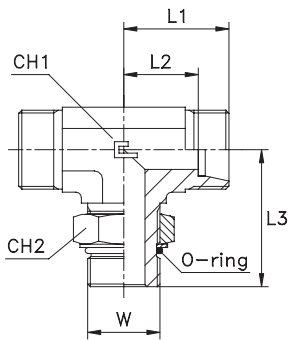

Series DIN	10.... [bar]	11.... [bar]	Ordering Body	Ordering Equipped B3	Ø Tube	W	L1	L2	L3	L4	CH1	CH2	CH3	Ordering Equipped B4		
L	315	315	107204.1	107204	6	7/16-20	19	12	27	27	11	14	14	107204.4		
			107205.1	107205	8	7/16-20	21	14	28	29	14	14	17	107205.4		
			107206.1	107206	10	9/16-18	22	15	32	30	14	17	19	107206.4		
			107207.1	107207	12	3/4-16	24	17	37	32	19	22	22	107207.4		
			107208.1	107208	15	7/8-14	28	21	43	36	22	27	27	107208.4		
			107209.1	107209	18	7/8-14	31	23.5	47	40	27	27	32	107209.4		
			107210.1	107210	22	1 1/16-12	35	27.5	49.5	44	27	32	36	107210.4		
			107211.1	107211	28	1 5/16-12	38	30.5	52	47	33	41	41	107211.4		
			107212.1	107212	35	1 5/8-12	45	34.5	58	56	41	50	50	107212.4		
S	400	400	107213.1	107213	42	1 7/8-12	51	40	60	63	48	55	60	107213.4		
			107214.1	107214	6	7/16-20	23	16	29	31	14	14	17	107214.4		
			107215.1	107215	8	9/16-18	24	17	33	32	14	17	19	107215.4		
			107216.1	107216	10	9/16-18	25	17.5	37.5	34	19	17	22	107216.4		
			107217.1	107217	12	3/4-16	29	21.5	38	38	19	22	24	107217.4		
			107218.1	107218	14	7/8-14	30	22	44	40	22	27	27	107218.4		
			107219.1	107219	16	7/8-14	33	24.5	48	43	27	27	30	107219.4		
			107220.1	107220	20	1 1/16-12	37	26.5	51	48	27	32	36	107220.4		
			107221.1	107221	25	1 5/16-12	42	30	53	54	33	41	46	107221.4		
			250	250	107222.1	107222	30	1 5/8-12	49	35.5	59	62	41	50	50	107222.4
					107223.1	107223	38	1 7/8-12	57	41	62	72	48	55	60	107223.4

Note: If you wish to order AISI 316 stainless steel fittings, please change the first two digits from **10....** to **11....** .
 If you wish to order AISI 316 stainless steel fittings with AISI 304 stainless steel nuts, please change the first two digits from **10....** to **14....** .
 Items not included in the ISO 8434-1 Norm available on request only.

BLANKING PLUG WITH O-RING - Per cono a 24° DIN 3861

Type: **1073..** Body
O-ring

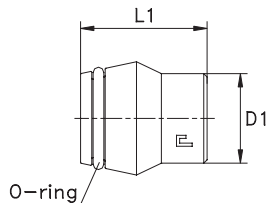

Type: **1073..-D**
With o-ring and nut

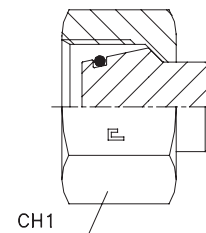

Series DIN	10.... [bar]	11.... [bar]	Ordering Body	Ordering Complete	Ø Tube	D1	L1	CH1
L	500	315	107304	107304-D	6	6	17	14
			107305	107305-D	8	8	17	17
			107306	107306-D	10	10	20	19
			107307	107307-D	12	12	21	22
			107308	107308-D	15	15	21	27
			107309	107309-D	18	18	23	32
			107310	107310-D	22	22	23	36
			107311	107311-D	28	28	25	41
			107312	107312-D	35	35	29	50
S	800	630	107313	107313-D	42	42	30	60
			107304	107314-D	6	6	17	17
			107305	107315-D	8	8	17	19
			107306	107316-D	10	10	20	22
			107307	107317-D	12	12	21	24
			107318	107318-D	14	14	23	27
	630	400	107319	107319-D	16	16	24	30
			107320	107320-D	20	20	28	36
			107321	107321-D	25	25	31	46
			107322	107322-D	30	30	34	50
			107323	107323-D	38	38	38	50

Note: If you wish to order AISI 316 stainless steel fittings, please change the first two digits from **10....** to **11....** .
 If you wish to order AISI 316 stainless steel fittings with AISI 304 stainless steel nuts, please change the first two digits from **10....** to **14....** .

MALE - FEMALE ADAPTER WITH ELASTOMER SEAL

Thread BSP Parallel

Type: 1074..

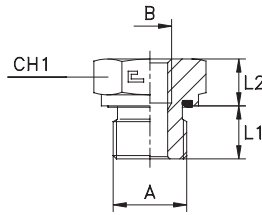

Series DIN	10.... [bar]	11.... [bar]	Ordering Complete	A	B	L1	L2	CH1
L/S	400	400	107401	3/8	1/8	12	10,5	22
			107402	1/2	1/8	14	10	27
			107403	1/2	1/4	14	10	27
	315	315	107404	3/4	1/4	16	10	32
			107405	3/4	3/8	16	10	32
			107406	1	1/4	18	11	41
			107407	1	3/8	18	11	41
			107408	1	1/2	18	11	41
			107409	1 1/4	1/2	20	12	50
			107410	1 1/4	3/4	20	12	50
	250	250	107411	1 1/2	1/2	22	14	55
			107412	1 1/2	3/4	22	14	55
			107413	1 1/2	1	22	14	55

Note: If you wish to order a fitting in stainless steel, please change the first two digit from 10.... to 11.... .

MALE - FEMALE ADAPTER WITH ELASTOMER SEAL

Thread BSP Parallel

Type: 1075..

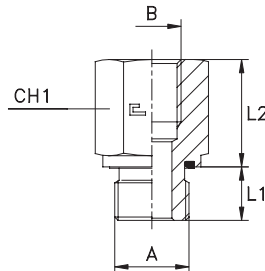

Series DIN	10.... [bar]	11.... [bar]	Ordering Complete	A	B	L1	L2	CH1
L/S	400	400	107501	1/8	1/4	8	23	19
			107502	1/8	3/8	8	24	24
			107503	1/4	1/8	12	16	19
			107504	1/4	3/8	12	24	24
			107505	1/4	1/2	12	28	30
			107506	1/4	3/4	12	31	36
			107507	3/8	1/4	12	24	22
			107508	3/8	1/2	12	29	30
	315	315	107509	3/8	3/4	12	32	36
	400	400	107510	1/2	3/8	14	22	27
	315	315	107511	1/2	3/4	14	32	36
			107512	1/2	1	14	35	41
			107513	1/2	1 1/4	14	39	55
			107514	3/4	1/2	16	26	32
			107515	3/4	1	16	35	41
			107516	3/4	1 1/4	16	39	55
	250	250	107517	3/4	1 1/2	16	41	60
	315	315	107518	1	3/4	18	29	41
			107519	1	1 1/4	18	39	55
	250	250	107520	1	1 1/2	18	41	60
	315	315	107521	1 1/4	1	20	31	50
	250	250	107522	1 1/4	1 1/2	20	40	60
			107523	1 1/2	1 1/4	22	36	55

Note: If you wish to order a fitting in stainless steel, please change the first two digit from 10.... to 11.... .

CLOSURE PLUG WITH EXAGON SOCKET HEAD WITH ELASTOMER SEAL

Thread BSP Parallel - Thread Metric Parallel

Type: 1076..

Type: 1077..

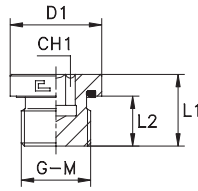

Series DIN	10.... [bar]	11.... [bar]	Ordering Complete	G	D1	L1	L2	CH1
S	400	400	107601	1/8	14	12	8	5
			107602	1/4	19	17	12	6
			107603	3/8	22	17	12	8
			107604	1/2	27	19	14	10
			107605	3/4	32	21	16	12
			107606	1	40	22,5	16	17
	250	250	107607	1 1/4	50	22,5	16	22
			107608	1 1/2	55	22,5	16	24

Note: If you wish to order a fitting in stainless steel, please change the first two digit from 10.... to 11.....

Series DIN	10.... [bar]	11.... [bar]	Ordering Complete	M	D1	L1	L2	CH1
S	400	400	107701	10x1	14	12	8	5
			107702	12x1,5	17	17	12	6
			107703	14x1,5	19	17	12	6
			107704	16x1,5	22	17	12	8
			107705	18x1,5	24	17	12	8
			107706	20x1,5	26	19	14	10
			107707	22x1,5	27	19	14	10
			107708	26x1,5	32	21	16	12
			107709	27x2	32	21	16	12
			107710	33x2	40	22,5	16	17
	250	250	107711	42x2	50	22,5	16	22
			107712	48x2	55	22,5	16	24

Note: If you wish to order a fitting in stainless steel, please change the first two digit from 10.... to 11.....

CLOSURE PLUG WITH EXAGON SOCKET HEAD WITH O-RING AND WASHER

Thread BSP Parallel - Thread Metric Parallel

Type: 1078..

Type: 1079..

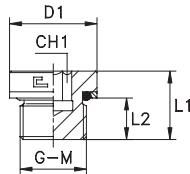

Series DIN	10.... [bar]	11.... [bar]	Ordering Complete	G	D1	L1	L2	CH1
L	315	315	107801	1/8	14	11,5	6,7	5
			107802	1/4	19	16	10,2	6
			107803	3/8	22	16	10,2	8
			107804	1/2	27	18	12,2	10
			107805	3/4	36	20	14,2	12
			107806	1	41	23	15,4	17
	200	200	107807	1 1/4	50	25	17,4	22
			107808	1 1/2	60	27	19,4	24

Note: If you wish to order a fitting in stainless steel, please change the first two digit from 10.... to 11.....

Series DIN	10.... [bar]	11.... [bar]	Ordering Complete	M	D1	L1	L2	CH1
L	315	315	107901	10x1	14	12	7,5	5
			107902	12x1,5	17	15	9,6	6
			107903	14x1,5	19	15	9,6	6
			107904	16x1,5	22	16,5	11,1	8
			107905	18x1,5	24	18	12,6	8
			107906	20x1,5	26	18	12,6	10
			107907	22x1,5	27	19	13,6	10
			107908	27x2	32	22,5	16,5	12
			107909	33x2	40	22,5	16,5	17
	160	160	107910	42x2	50	24	17	22
			107911	48x2	55	26,5	19,5	24

Note: If you wish to order a fitting in stainless steel, please change the first two digit from 10.... to 11.....

BLANKING PLUG FOR TUBE ENDS

Type: **1080...1** Body

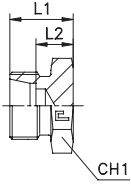

Type: **1080.. B3** Ring

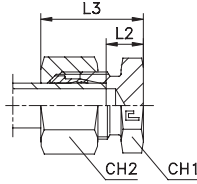

Type: **1080...4** B4 Ring

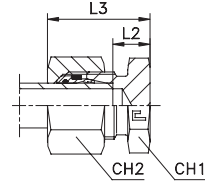

Series DIN	10.... [bar]	11.... [bar]	Ordering Body	Ordering Equipped B3	Ø Tube	L1	L2	L3	CH1	CH2	Ordering Equipped B4
L	315	315	108004.1	108004	6	14	7	21,5	12	14	108004.4
			108005.1	108005	8	15	8	23	14	17	108005.4
			108006.1	108006	10	16	9	24	17	19	108006.4
			108007.1	108007	12	17	10	24,5	19	22	108007.4
			108008.1	108008	15	18	11	26	24	27	108008.4
	108009.1	108009	18	19	11,5	28	27	32	108009.4		
	160	160	108010.1	108010	22	21	13,5	30	32	36	108010.4
			108011.1	108011	28	22	14,5	31	41	41	108011.4
			108012.1	108012	35	25	14,5	36	46	50	108012.4
			108013.1	108013	42	27	16	39	55	60	108013.4
108014.1			108014	6	18	11	26	14	17	108014.4	
S	630	630	108015.1	108015	8	20	13	28	17	19	108015.4
			108016.1	108016	10	20	12,5	28,5	19	22	108016.4
			108017.1	108017	12	22	14,5	30,5	22	24	108017.4
			108018.1	108018	14	24	16	34	24	27	108018.4
			108019.1	108019	16	24	15,5	34	27	30	108019.4
	400	400	108020.1	108020	20	28	17,5	39	32	36	108020.4
			108021.1	108021	25	32	20	44	41	46	108021.4
			108022.1	108022	30	34	20,5	47	46	50	108022.4
			108023.1	108023	38	39	23	54	55	60	108023.4
			315	315							

Note: If you wish to order AISI 316 stainless steel fittings, please change the first two digits from **10....** to **11....** .

If you wish to order AISI 316 stainless steel fittings with AISI 304 stainless steel nuts, please change the first two digits from **10....** to **14....** .

ALLOW SCREW FOR BANJOS - Thread BSP Parallel - Thread Metric Parallel

Type: **1081..**

Type: **1082..**

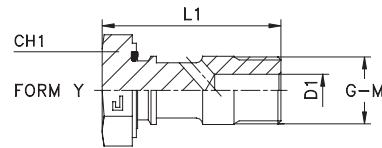
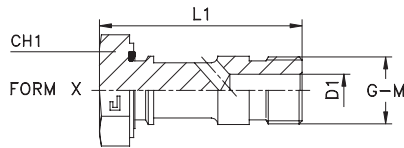

Series DIN	10.... [bar]	11.... [bar]	Ordering Complete	G	Allow's form	Banjos form 1013.. 1014..	D1	L1	CH1			
L/S	-	-	108101	1/8	X	X	4	32	17			
			108102	1/4	X	X	5	44	19			
			108103	3/8	X	X	8	50,5	24			
			108104	1/2	X	X	10	60,5	30			
			108105	3/4	X	X	14,5	70	36			
			108106	1	X	X	21	84,5	46			
			108107	1 1/4	X	X	26	100	55			
			108108	1 1/2	X	X	30	112	60			
			108151	1/8	Y	Y	4	27,5	14			
			108152	1/4	Y	Y	5	36,5	19			
			108153	3/8	Y	Y	8	41,5	22			
			108154	1/2	Y	Y	10	55	27			
			108155	3/4	Y	Y	14,5	61	32			
			L/S	-	-	108201	8x1	X	X	3	32	14
						108202	10x1	X	X	4	32	17
108203	12x1,5	X				X	4	44	19			
108204	14x1,5	X				X	5	44	19			
108205	16x1,5	X				X	8	50,5	24			
108206	18x1,5	X				X	8	54	27			
108207	20x1,5	X				X	10	59	30			
108208	22x1,5	X				X	10	60,5	30			
108209	26x1,5	X				X	14,5	70	36			
108210	27x2	X				X	14,5	70	36			
108211	33x2	X				X	21	84,5	46			
108212	42x2	X				X	26	100	55			
108213	48x2	X				X	30	112	60			
108251	8x1	Y				Y	3	27,5	12			
108252	10x1	Y				Y	4	27,5	14			
108253	12x1,5	Y				Y	4	36,5	17			
108254	14x1,5	Y				Y	5	36,5	19			
108255	16x1,5	Y				Y	8	41,5	22			
108256	18x1,5	Y				Y	8	46	24			
108257	20x1,5	Y				Y	10	55	27			
108258	22x1,5	Y				Y	10	55	27			
108259	26x1,5	Y	Y	14,5	61	32						
108260	27x2	Y	Y	14,5	61	32						

Note: If you wish to order a fitting in stainless steel, please change the first two digit from **10....** to **11....** .

Items not included in the ISO 8434-1 Norm.

SEALING WASHER

Gauge fitting – Adjustable elbow
Thread BSP Parallel - Thread Metric Parallel

Type: 1084..

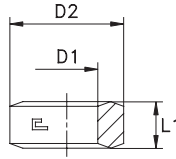

O-RING SEALING WASHER

Gauge fitting
Thread BSP Parallel

Type: 1085..

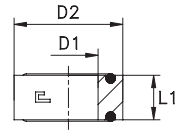

Series DIN	10.... [bar]	11.... [bar]	Ordering Complete	D1	D2	L1	Thread	Applications
L/S	-	-	108401	6	11	4,5	G 1/4	Gauge fitting 1059..
			108402	9	18	5	G 1/2	Gauge fitting 1059..
			108411	9,8	14,5	3	G 1/8	Adjustable elbow 1013..
			108412	13,3	18	3	G 1/4	Adjustable elbow 1013..
			108413	16,8	22	3	G 3/8	Adjustable elbow 1013..
			108414	21,1	26	4	G 1/2	Adjustable elbow 1013..
			108415	26,5	32	4	G 3/4	Adjustable elbow 1013..
			108421	8,1	12,5	3	M 8x1	Adjustable elbow 1014..
			108422	10,1	14,5	3	M 10x1	Adjustable elbow 1014..
			108423	12,1	17	3	M 12x1,5	Adjustable elbow 1014..
			108424	14,1	19	3	M 14x1,5	Adjustable elbow 1014..
			108425	16,1	21	3	M 16x1,5	Adjustable elbow 1014..
			108426	18,1	23	3	M 18x1,5	Adjustable elbow 1014..
			108427	20,1	25	4	M 20x1,5	Adjustable elbow 1014..
			108428	22,1	27	4	M 22x1,5	Adjustable elbow 1014..
108429	26,1	32	4	M 26x1,5	Adjustable elbow 1014..			
108430	27,1	32	4	M 27x2	Adjustable elbow 1014..			
L/S	-	-	108501	6	11	4,5	1/4	Gauge fitting 1059...4
			108502	9	18	5	1/2	Gauge fitting 1059...4

Note: If you wish to order a fitting in stainless steel, please change the first two digit from 10.... to 11.... .
Items not included in the ISO 8434-1 Norm.

PIPE INSERT

Thin wall pipe

Type: 1086..

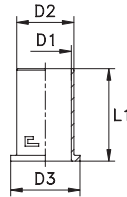

Series DIN	10.... [bar]	11.... [bar]	Ordering Complete	Ø Tube	D1	D2	D3	L1
L/S	-	-	108601	6	3	3,9	6	11
			108602	8	5	5,9	8	14
			108603	10	7	7,9	10	15
			108604	12	9	9,9	12	16
			108605	15	12	12,9	15	17
			108606	18	14	14,9	18	20
			108607	20	15	15,9	20	20
			108608	22	16	17,9	22	20
			108609	28	22	23,9	28	23,5
			108610	30	24	25,9	30	23,5
			108611	35	28	30,9	35	26,5

Note: If you wish to order a fitting in stainless steel, please change the first two digit from 10.... to 11.... .
Items not included in the ISO 8434-1 Norm.

EXAGONAL NUT

Bulkhead fitting

Type: 1087..

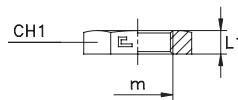

Series DIN	10.... [bar]	11.... [bar]	Ordering Complete	m	L1	CH1	Ø Tube	Ø Tube
L/S	-	-	108704	12x1,5	6	17	6L	-
			108705	14x1,5	6	19	8L	6S
			108706	16x1,5	6	22	10L	8S
			108707	18x1,5	6	24	12L	10S
			108708	20x1,5	6	27	-	12S
			108709	22x1,5	7	30	15L	14S
			108710	24x1,5	7	32	-	16S
			108711	26x1,5	8	36	18L	-
			108712	30x2	8	41	22L	20S
			108713	36x2	9	46	28L	25S
			108714	42x2	9	50	-	30S
			108715	45x2	9	55	35L	-
			108716	52x2	10	65	42L	38S

Note: If you wish to order a fitting in stainless steel, please change the first two digit from 10.... to 11.... .

MALE STUD COUPLING WITH O-RING AND WASHER

Thread BSP Parallel - Thread Metric Parallel

Type: **1088...1** Body
Type: **1089...1** Body

Type: **1088.. B3** Ring
Type: **1089.. B3** Ring

Type: **1088...4** B4 Ring
Type: **1089...4** B4 Ring

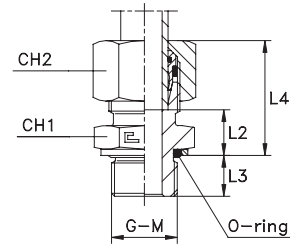
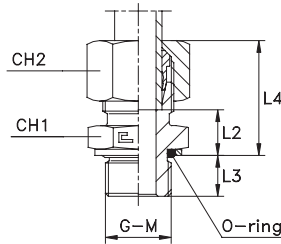
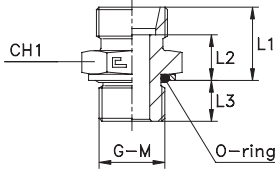

Series DIN	10.... [bar]	11.... [bar]	Ordering Body	Ordering Equipped B3	Ø Tube	G	L1	L2	L3	L4	CH1	CH2	Ordering Equipped B4
LL	100	100	108801.1	108801	4	1/8	13,3	9,3	6,7	19,8	14	10	-
			108802.1	108802	6	1/8	13,3	7,8	6,7	19,8	14	12	-
			108803.1	108803	8	1/8	14,3	8,8	6,7	20,8	14	14	-
L	315	315	108804.1	108804	6	1/8	15,3	8,3	6,7	22,8	14	14	108804.4
			108805.1	108805	8	1/4	16,8	9,8	10,2	24,8	19	17	108805.4
			108806.1	108806	10	1/4	17,8	10,8	10,2	25,8	19	19	108806.4
			108807.1	108807	12	3/8	19,3	12,3	10,2	26,8	22	22	108807.4
			108808.1	108808	15	1/2	20,8	13,8	12,2	28,8	27	27	108808.4
			108809.1	108809	18	1/2	21,8	14,3	12,2	30,8	27	32	108809.4
	160	160	108810.1	108810	22	3/4	23,8	16,3	12,7	32,8	36	36	108810.4
			108811.1	108811	28	1	25,1	17,6	15,4	34,1	41	41	108811.4
			108812.1	108812	35	1 1/4	28	17,6	16	39,1	50	50	108812.4
			108813.1	108813	42	1 1/2	30	19,1	16	42,1	55	60	108813.4
S	400	400	108814.1	108814	6	1/4	19,8	12,8	10,2	27,8	19	17	108814.4
			108815.1	108815	8	1/4	21,8	14,8	10,2	29,8	19	19	108815.4
	315	315	108816.1	108816	10	3/8	22,3	14,8	10,2	30,8	22	22	108816.4
			108817.1	108817	12	3/8	24,3	16,8	10,2	32,8	22	24	108817.4
			108818.1	108818	14	1/2	26,8	18,8	12,2	36,8	27	27	108818.4
			108819.1	108819	16	1/2	26,8	18,3	12,2	36,8	27	30	108819.4
			108820.1	108820	20	3/4	30,8	20,3	12,7	41,8	36	36	108820.4
	280	280	108821.1	108821	25	1	35,1	23,1	15,4	47,1	41	46	108821.4
			108822.1	108822	30	1 1/4	37	23,6	16	50,1	50	50	108822.4
			108823.1	108823	38	1 1/2	42	26,1	16	57,1	55	60	108823.4

Note: If you wish to order AISI 316 stainless steel fittings, please change the first two digits from **10....** to **11....** .
If you wish to order AISI 316 stainless steel fittings with AISI 304 stainless steel nuts, please change the first two digits from **10....** to **14....** .
Items not included in the ISO 8434-1 Norm available on request only.

Series DIN	10.... [bar]	11.... [bar]	Ordering Body	Ordering Equipped B3	Ø Tube	M	L1	L2	L3	L4	CH1	CH2	Ordering Equipped B4
LL	100	100	108901.1	108901	4	10x1	13,5	9,5	7,5	20	14	10	-
			108902.1	108902	6	10x1	13,5	8	7,5	20	14	12	-
			108903.1	108903	8	10x1	14,5	9	7,5	21	14	14	-
L	315	315	108904.1	108904	6	10x1	15,5	8,5	7,5	23	14	14	108904.4
			108905.1	108905	8	12x1,5	16,9	9,9	9,6	24,9	17	17	108905.4
			108906.1	108906	10	14x1,5	17,9	10,9	9,6	25,9	19	19	108906.4
			108907.1	108907	12	16x1,5	19,4	12,4	11,1	26,9	22	22	108907.4
			108908.1	108908	15	18x1,5	20,4	13,4	12,6	28,3	24	27	108908.4
			108909.1	108909	18	22x1,5	21,9	14,4	13,6	30,3	27	32	108909.4
	160	160	108910.1	108910	22	27x2	24	16,5	16,5	33	32	36	108910.4
			108911.1	108911	28	33x2	25	17,5	16,5	34	41	41	108911.4
			108912.1	108912	35	42x2	28	17,5	17	39	50	50	108912.4
			108913.1	108913	42	48x2	30	19	19,5	42	55	60	108913.4
S	400	400	108914.1	108914	6	12x1,5	19,9	12,9	9,6	27,9	17	17	108914.4
			108915.1	108915	8	14x1,5	21,9	14,9	9,6	29,9	19	19	108915.4
			108916.1	108916	10	16x1,5	22,4	14,9	11,1	30,9	22	22	108916.4
			108917.1	108917	12	18x1,5	24,4	16,9	12,6	32,9	24	24	108917.4
	315	315	108918.1	108918	14	20x1,5	26,9	18,9	12,6	36,9	27	27	108918.4
			108919.1	108919	16	22x1,5	26,9	18,4	13,6	36,9	27	30	108919.4
			108920.1	108920	20	27x2	31	20,5	16,5	42	32	36	108920.4
	280	280	108921.1	108921	25	33x2	35	23	16,5	47	41	46	108921.4
			108922.1	108922	30	42x2	37	23,5	17	50	50	50	108922.4
	250	250	108923.1	108923	38	48x2	42	26	19,5	57	55	60	108923.4

Note: If you wish to order AISI 316 stainless steel fittings, please change the first two digits from **10....** to **11....** .
If you wish to order AISI 316 stainless steel fittings with AISI 304 stainless steel nuts, please change the first two digits from **10....** to **14....** .
Items not included in the ISO 8434-1 Norm available on request only.

MALE STUD COUPLING WITH SWIVEL NUT AND ELASTOMER SEAL

Thread BSP Parallel

Type: 6005..

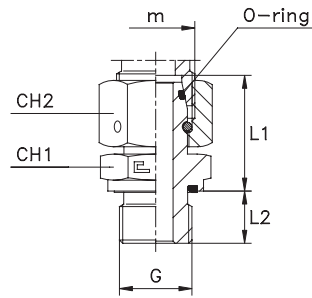

Series DIN	60.... [bar]	61.... [bar]	Ordering Complete	Ø Tube	m	G	L1	L2	CH1	CH2
L	500	315	600504	6	12x1,5	1/8	24,5	8	14	14
			600505	8	14x1,5	1/4	29,5	12	19	17
			600506	10	16x1,5	1/4	27,5	12	19	19
	600507		12	18x1,5	3/8	34	12	22	22	
	600508		15	22x1,5	1/2	32	14	27	27	
	600509		18	26x1,5	1/2	31,5	14	27	32	
	250	160	600510	22	30x2	3/4	32,5	16	32	36
			600511	28	36x2	1	35	18	41	41
			600512	35	45x2	1 1/4	42,5	20	50	50
			600513	42	52x2	1 1/2	46,5	22	55	60
S	800	630	600514	6	14x1,5	1/4	27	12	19	17
			600515	8	16x1,5	1/4	29,5	12	19	19
			600516	10	18x1,5	3/8	32,5	12	22	22
	600517		12	20x1,5	3/8	34,5	12	22	24	
	600518		14	22x1,5	1/2	36,5	14	27	27	
	600519		16	24x1,5	1/2	37	14	27	30	
	420	400	600520	20	30x2	3/4	43	16	32	36
			600521	25	36x2	1	48	18	41	46
			600522	30	42x2	1 1/4	51	20	50	50
			600523	38	52x2	1 1/2	60	22	55	60
L	500	315	600524	6	12x1,5	1/4	27	12	19	14
			600525	10	16x1,5	3/8	29	12	22	19
			600526	12	18x1,5	1/4	27,5	12	19	22
	600527		12	18x1,5	1/2	30	14	27	22	
	600528		15	22x1,5	3/8	31,5	12	22	27	
	600529		15	22x1,5	3/4	30,5	16	32	27	
	250	160	600530	18	26x1,5	3/4	31,5	16	32	32
			600531	22	30x2	1	34	18	41	36
			600532	28	36x2	3/4	33,5	16	32	41
			600533	35	45x2	1	39,5	18	41	50
600534	35	45x2	1 1/2	46,5	22	55	50			
S	500	315	600535	6	14x1,5	1/8	24,5	8	14	17
	800	630	600536	8	16x1,5	3/8	31,5	12	22	19
			600537	10	18x1,5	1/4	30,5	12	19	22
	630	400	600538	10	18x1,5	1/2	32	14	27	22
		630	600539	12	20x1,5	1/4	30,5	12	19	24
		400	600540	12	20x1,5	1/2	34	14	27	24
		630	600541	14	22x1,5	3/8	37	12	22	27
	420	400	600542	16	24x1,5	3/8	39,5	12	22	30
			600543	20	30x2	1/2	41,5	14	27	36
			600544	20	30x2	1	45,5	18	41	36
			600545	25	36x2	1/2	42	14	32	46
			600546	25	36x2	3/4	45,5	16	32	46
			600547	25	36x2	1 1/4	48,5	20	50	46
			600548	30	42x2	1	50,5	18	41	50
			600549	30	42x2	1 1/2	58	22	55	50
	315	600550	38	52x2	1 1/4	53	20	50	60	

Note: If you wish to order a fitting in stainless steel, please change the first two digit from 60.... to 61.... .

MALE STUD COUPLING WITH SWIVEL NUT AND ELASTOMER SEAL

Thread Metric Parallel

Type: 6006..

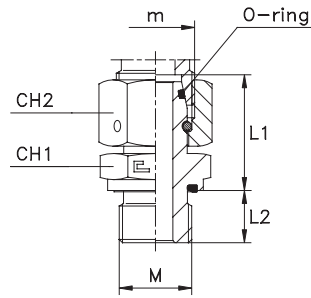

Series DIN	60.... [bar]	61.... [bar]	Ordering Complete	Ø Tube	m	M	L1	L2	CH1	CH2
L	500	315	600604	6	12x1,5	10x1	24,5	8	14	14
			600605	8	14x1,5	12x1,5	26,5	12	17	17
			600606	10	16x1,5	14x1,5	27,5	12	19	19
			600607	12	18x1,5	16x1,5	30,5	12	22	22
			600608	15	22x1,5	18x1,5	31,5	12	24	27
	400	160	600609	18	26x1,5	22x1,5	31,5	14	27	32
			600610	22	30x2	26x1,5	32,5	16	32	36
			600611	28	36x2	33x2	35	18	41	41
			600612	35	45x2	42x2	42,5	20	50	50
			600613	42	52x2	48x2	46	22	55	60
S	800	630	600614	6	14x1,5	12x1,5	27	12	17	17
			600615	8	16x1,5	14x1,5	29,5	12	19	19
			600616	10	18x1,5	16x1,5	32,5	12	22	22
			600617	12	20x1,5	18x1,5	34,5	12	24	24
	630	400	600618	14	22x1,5	20x1,5	36,5	14	27	27
			600619	16	24x1,5	22x1,5	37	14	27	30
			600620	20	30x2	27x2	43	16	32	36
			600621	25	36x2	33x2	48	18	41	46
	420	315	600622	30	42x2	42x2	51	20	50	50
			600623	38	52x2	48x2	60	22	55	60
L	500	315	600624	6	12x1,5	12x1,5	26,5	12	17	14
			600625	8	14x1,5	14x1,5	27	12	19	17
			600626	10	16x1,5	16x1,5	30,5	12	22	19
			600627	12	18x1,5	14x1,5	27,5	12	19	22
			600628	12	18x1,5	18x1,5	29,5	12	24	22
			600629	12	18x1,5	22x1,5	30	14	27	22
	400	160	600630	15	22x1,5	22x1,5	30,5	14	27	27
			600631	18	26x1,5	26x1,5	31,5	16	32	32
			600632	6	14x1,5	10x1	24,5	8	14	17
			600633	8	16x1,5	12x1,5	27,5	12	17	19
800	630	600634	10	18x1,5	14x1,5	30,5	12	19	22	
		600635	12	20x1,5	14x1,5	30,5	12	19	24	
		600636	12	20x1,5	16x1,5	34,5	12	22	24	
		600637	12	20x1,5	22x1,5	35	14	27	24	

Note: If you wish to order a fitting in stainless steel, please change the first two digit from 60.... to 61....

MALE STUD COUPLING WITH SWIVEL NUT O-RING AND WASHER

Thread BSP Parallel - Thread Metric Parallel

Type: 6007..

Type: 6008..

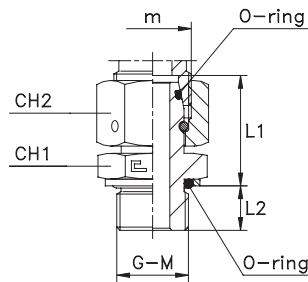

Series DIN	60.... [bar]	61.... [bar]	Ordering Complete	Ø Tube	m	G	L1	L2	CH1	CH2
L	315	315	600704	6	12x1,5	1/8	25,8	6,7	14	14
			600705	8	14x1,5	1/4	31,3	10,2	19	17
			600706	10	16x1,5	1/4	29,3	10,2	19	19
			600707	12	18x1,5	3/8	35,8	10,2	22	22
			600708	15	22x1,5	1/2	33,8	12,2	27	27
	600709	18	26x1,5	1/2	33,3	12,2	27	32		
	160	160	600710	22	30x2	3/4	34,3	12,7	36	36
			600711	28	36x2	1	37,6	15,4	41	41
			600712	35	45x2	1 1/4	45	16	50	50
			600713	42	52x2	1 1/2	49	16	55	60
600714			6	14x1,5	1/4	28,8	10,2	19	17	
S	400	400	600715	8	16x1,5	1/4	31,3	10,2	19	19
			600716	10	18x1,5	3/8	34,3	10,2	22	22
	315	315	600717	12	20x1,5	3/8	36,3	10,2	22	24
			600718	14	22x1,5	1/2	38,3	12,2	27	27
			600719	16	24x1,5	1/2	38,8	12,2	27	30
			600720	20	30x2	3/4	44,8	12,7	36	36
			600721	25	36x2	1	50,6	15,4	41	46
	280	280	600722	30	42x2	1 1/4	53,5	16	50	50
			600723	38	52x2	1 1/2	62,5	16	55	60

Note: If you wish to order a fitting in stainless steel, please change the first two digit from 60.... to 61.... .
Items available on request only.

Series DIN	60.... [bar]	61.... [bar]	Ordering Complete	Ø Tube	m	M	L1	L2	CH1	CH2
L	315	315	600804	6	12x1,5	10x1	25	7,5	14	14
			600805	8	14x1,5	12x1,5	28,9	9,6	17	17
			600806	10	16x1,5	14x1,5	29,9	9,6	19	19
			600807	12	18x1,5	16x1,5	31,4	11,1	22	22
			600808	15	22x1,5	18x1,5	30,9	12,6	24	27
	600809	18	26x1,5	22x1,5	31,9	13,6	27	32		
	160	160	600810	22	30x2	27x2	32	16,5	32	36
			600811	28	36x2	33x2	36,5	16,5	41	41
			600812	35	45x2	42x2	45,5	17	50	50
			600813	42	52x2	48x2	47,5	19,5	55	60
600814			6	14x1,5	12x1,5	28,4	9,6	17	17	
S	400	400	600815	8	16x1,5	14x1,5	30,9	9,6	19	19
			600816	10	18x1,5	16x1,5	33,4	11,1	22	22
	315	315	600817	12	20x1,5	18x1,5	33,9	12,6	24	24
			600818	14	22x1,5	20x1,5	35,4	12,6	27	27
			600819	16	24x1,5	22x1,5	36,4	13,6	27	30
			600820	20	30x2	27x2	42,5	16,5	32	36
			600821	25	36x2	33x2	46,5	16,5	41	46
	280	280	600822	30	42x2	42x2	52	17	50	50
			600823	38	52x2	48x2	62,5	19,5	55	60

Note: If you wish to order a fitting in stainless steel, please change the first two digit from 60.... to 61.... .
Items available on request only.

MALE STUD COUPLING WITH SWIVEL NUT AND O-RING

Thread UNF/UN-2A

Type: **6009..**

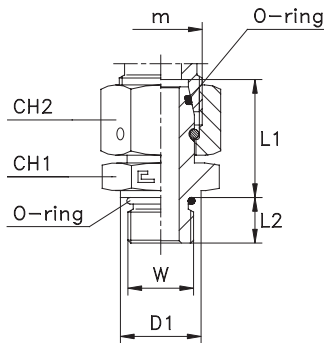

MALE STUD COUPLING WITH SWIVEL NUT

Thread NPT

Type: **6010..**

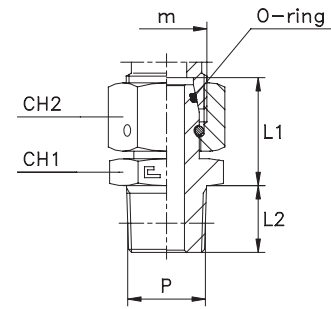

Series DIN	60.... [bar]	61.... [bar]	Ordering Complete	Ø Tube	m	W	D1	L1	L2	CH1	CH2
L	315	315	600904	6	12x1,5	7/16-20	13,8	24,4	9,1	14	14
			600905	8	14x1,5	7/16-20	13,8	24,4	9,1	14	17
			600906	10	16x1,5	9/16-18	18,8	27,5	10	19	19
			600907	12	18x1,5	3/4-16	21,8	33,9	11,1	22	22
			600908	15	22x1,5	7/8-14	26,8	32,3	12,7	27	27
	600909	18	26x1,5	7/8-14	26,8	31,8	12,7	27	32		
	160	160	600910	22	30x2	1 1/16-12	31,8	32,4	15,1	32	36
			600911	28	36x2	1 5/16-12	40,8	34,9	15,1	41	41
			600912	35	45x2	1 5/8-12	49,8	42,4	15,1	50	50
			600913	42	52x2	1 7/8-12	54,8	46,4	15,1	55	60
600914			6	14x1,5	7/16-20	13,8	26,9	9,1	14	17	
S	630	630	600915	8	16x1,5	9/16-18	18,8	29,5	10	17	19
			600916	10	18x1,5	9/16-18	18,8	30,5	10	17	22
			600917	12	20x1,5	3/4-16	21,8	34,4	11,1	22	24
			600918	14	22x1,5	7/8-14	26,8	36,3	12,7	27	27
			600919	16	24x1,5	7/8-14	26,8	36,8	12,7	27	30
	400	400	600920	20	30x2	1 1/16-12	31,8	42,9	15,1	32	36
			600921	25	36x2	1 5/16-12	40,8	47,9	15,1	41	46
			600922	30	42x2	1 5/8-12	49,8	50,9	15,1	50	50
			600923	38	52x2	1 7/8-12	54,8	59,9	15,1	55	60
			315	315	600923	38	52x2	1 7/8-12	54,8	59,9	15,1

Note: If you wish to order a fitting in stainless steel, please change the first two digit from **60....** to **61....** .
Items available on request only.

Series DIN	60.... [bar]	61.... [bar]	Ordering Complete	Ø Tube	m	P	L1	L2	CH1	CH2
L	315	315	601004	6	12x1,5	1/8	23	10	12	14
			601005	8	14x1,5	1/4	27,5	15	14	17
			601006	10	16x1,5	1/4	25,5	15	14	19
			601007	12	18x1,5	3/8	31,5	15	19	22
			601008	15	22x1,5	1/2	29	19,5	22	27
	601009	18	26x1,5	1/2	28,5	19,5	24	32		
	160	160	601010	22	30x2	3/4	29,5	20	27	36
			601011	28	36x2	1	32	25	36	41
			601012	35	45x2	1 1/4	39,5	25,5	46	50
			601013	42	52x2	1 1/2	43,5	26	50	60
601014			6	14x1,5	1/4	25	15	14	17	
S	630	630	601015	8	16x1,5	1/4	27,5	15	14	19
			601016	10	18x1,5	3/8	30	15	19	22
			601017	12	20x1,5	3/8	32	15	19	24
			601018	14	22x1,5	1/2	33,5	19,5	22	27
			601019	16	24x1,5	1/2	34	19,5	22	30
	400	400	601020	20	30x2	3/4	40	20	27	36
			601021	25	36x2	1	45	25	36	46
			601022	30	42x2	1 1/4	48	25,5	46	50
			601023	38	52x2	1 1/2	57	26	50	60
			315	315	601023	38	52x2	1 1/2	57	26

Note: If you wish to order a fitting in stainless steel, please change the first two digit from **60....** to **61....** .
Items available on request only.

STRAIGHT COUPLING WITH SWIVEL NUT

Type: 6035..

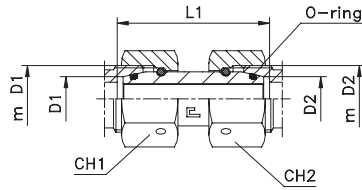

Series DIN	60.... [bar]	61.... [bar]	Ordering Complete	Ø Tube		m D1	m D2	L1	CH1	CH2	
				D1	D2						
L	500	315	603504	6	6	12x1,5	12x1,5	40	14	14	
			603505	8	8	14x1,5	14x1,5	40	17	17	
			603506	10	10	16x1,5	16x1,5	40	19	19	
			603507	12	12	18x1,5	18x1,5	40	22	22	
			603508	15	15	22x1,5	22x1,5	44	27	27	
	400	160	603509	18	18	26x1,5	26x1,5	43	32	32	
			603510	22	22	30x2	30x2	50	36	36	
			603511	28	28	36x2	36x2	51	41	41	
			603512	35	35	45x2	45x2	62	50	50	
			603513	42	42	52x2	52x2	62	60	60	
S	800	630	603514	6	6	14x1,5	14x1,5	41	17	17	
			603515	8	8	16x1,5	16x1,5	41	19	19	
			603516	10	10	18x1,5	18x1,5	44	22	22	
			603517	12	12	20x1,5	20x1,5	45	24	24	
	630	400	603518	14	14	22x1,5	22x1,5	49	27	27	
			603519	16	16	24x1,5	24x1,5	52	30	30	
			603520	20	20	30x2	30x2	61	36	36	
			603521	25	25	36x2	36x2	68	46	46	
			603522	30	30	42x2	42x2	74	50	50	
	L	500	315	603523	38	38	52x2	52x2	83	60	60
				603524	8	6	14x1,5	12x1,5	37	17	14
				603525	10	6	16x1,5	12x1,5	36,5	19	14
				603526	12	6	18x1,5	12x1,5	36,5	22	14
603527				10	8	16x1,5	14x1,5	36,5	19	17	
603528				12	8	18x1,5	14x1,5	36,5	22	17	
603529				15	8	22x1,5	14x1,5	40,5	27	17	
603530				12	10	18x1,5	16x1,5	36	22	19	
603531				15	10	22x1,5	16x1,5	40	27	19	
603532				18	10	26x1,5	16x1,5	39,5	32	19	
603533				15	12	22x1,5	18x1,5	40	27	22	
603534	18	12	26x1,5	18x1,5	39,5	32	22				
L	250	160	603535	22	12	30x2	18x1,5	42,5	36	22	
	400	315	603536	18	15	26x1,5	22x1,5	43,5	32	27	
			603537	22	15	30x2	22x1,5	46,5	36	27	
			603538	28	15	36x2	22x1,5	47,5	41	27	
			603539	22	18	30x2	26x1,5	46	36	32	
			603540	28	18	36x2	26x1,5	47	41	32	
			603541	35	18	45x2	26x1,5	52,5	50	32	
			603542	28	22	36x2	30x2	50	41	36	
			603543	35	22	45x2	30x2	55,5	50	36	
			603544	42	22	52x2	30x2	55,5	60	36	
			603545	35	28	45x2	36x2	56,5	50	41	
	603546	42	28	52x2	36x2	56,5	60	41			
	603547	42	35	52x2	45x2	62	60	50			

Note: If you wish to order a fitting in stainless steel, please change the first two digit from 60.... to 61....

STRAIGHT COUPLING WITH SWIVEL NUT

Type: 6035..

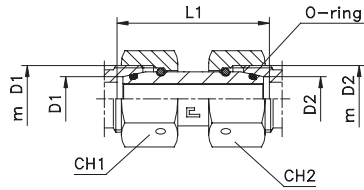

Series DIN	60.... [bar]	61.... [bar]	Ordering Complete	Ø Tube		m D1	m D2	L1	CH1	CH2	
				D1	D2						
S	800	630	603548	8	6	16x1,5	14x1,5	37	19	17	
	630		603549	10	6	18x1,5	14x1,5	38	22	17	
			603550	12	6	20x1,5	14x1,5	39	24	17	
	800		630	603551	10	8	18x1,5	16x1,5	38	22	19
	630			603552	12	8	20x1,5	16x1,5	39	24	19
			603553	12	10	20x1,5	18x1,5	40	24	22	
		603554	16	10	24x1,5	18x1,5	44	30	22		
		400	603555	16	12	24x1,5	20x1,5	45	30	24	
			603556	20	12	30x2	20x1,5	48,5	36	24	
			603557	20	16	30x2	24x1,5	52,5	36	30	
			603558	25	16	36x2	24x1,5	56	46	30	
			603559	30	16	42x2	24x1,5	58,5	50	30	
			603560	25	20	36x2	30x2	59,5	46	36	
		420	603561	30	20	42x2	30x2	62	50	36	
	315		603562	38	20	52x2	30x2	64	60	36	
	400		603563	30	25	42x2	36x2	65,5	50	46	
	315		603564	38	25	52x2	36x2	67,5	60	46	
			603565	38	30	52x2	42x2	70	60	50	
S/L	500		315	603566	6	6	14x1,5	12x1,5	37	17	14
		603567		8	8	16x1,5	14x1,5	37	19	17	
		603568		10	10	18x1,5	16x1,5	37,5	22	19	
	400	603569		12	12	20x1,5	18x1,5	38,5	24	22	
		603570		16	15	24x1,5	22x1,5	46,5	30	27	
		603571		18	16	26x1,5	24x1,5	46	32	30	
L/S	250	160	603572	20	18	30x2	26x1,5	49,5	36	32	
L/S			603573	22	20	30x2	30x2	52,5	36	36	
S/L			603574	25	22	36x2	30x2	56	46	36	
L/S			603575	28	25	36x2	36x2	57	41	46	
S/L			603576	30	28	42x2	36x2	59,5	50	41	
L/S			603577	35	30	45x2	42x2	65	50	50	
S/L			603578	38	35	52x2	45x2	67	60	50	
L/S			603579	42	38	52x2	52x2	67	60	60	

Note: If you wish to order a fitting in stainless steel, please change the first two digit from 60.... to 61....

ADJUSTABLE MALE STUD ELBOW

Type: **6042...1** Body

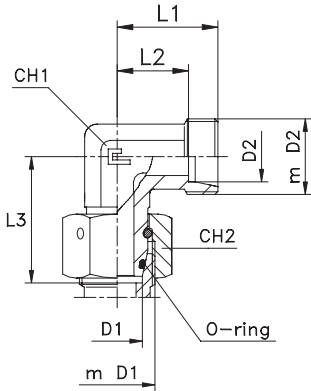

Type: **6042.. B3** Ring

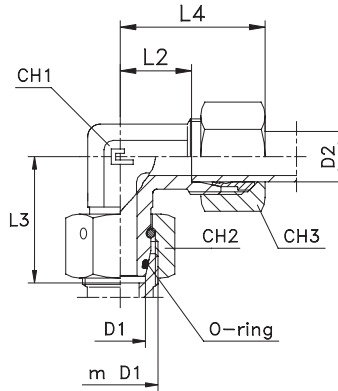

Type: **6042...4** B4 Ring

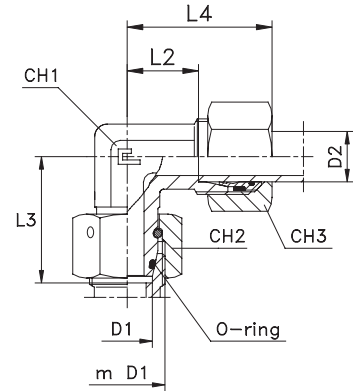

Series DIN	60.... [bar]	61.... [bar]	Ordering Body	Ordering Equipped B3	Ø Tube		m		L1	L2	L3	L4	CH1	CH2	CH3	Ordering Equipped B4
					D1	D2	D1	D2								
L	500	315	604204.1	604204	6	6	12x1,5	12x1,5	19	12	26	27	12	14	14	604204.4
			604205.1	604205	8	8	14x1,5	14x1,5	21	14	27,5	29	12	17	17	604205.4
			604206.1	604206	10	10	16x1,5	16x1,5	22	15	29	30	14	19	19	604206.4
	400	315	604207.1	604207	12	12	18x1,5	18x1,5	24	17	29,5	32	17	22	22	604207.4
			604208.1	604208	15	15	22x1,5	22x1,5	28	21	32,5	36	19	27	27	604208.4
			604209.1	604209	18	18	26x1,5	26x1,5	31	23,5	35,5	40	24	32	32	604209.4
	250	160	604210.1	604210	22	22	30x2	30x2	35	27,5	38,5	44	27	36	36	604210.4
			604211.1	604211	28	28	36x2	36x2	38	30,5	41,5	47	36	41	41	604211.4
			604212.1	604212	35	35	45x2	45x2	45	34,5	51,5	56	41	50	50	604212.4
			604213.1	604213	42	42	52x2	52x2	51	40	56	63	50	60	60	604213.4
S	800	630	604214.1	604214	6	6	14x1,5	14x1,5	23	16	27	31	12	17	17	604214.4
			604215.1	604215	8	8	16x1,5	16x1,5	24	17	27,5	32	14	19	19	604215.4
			604216.1	604216	10	10	18x1,5	18x1,5	25	17,5	30,5	34	17	22	22	604216.4
	630	630	604217.1	604217	12	12	20x1,5	20x1,5	29	21,5	31,5	38	17	24	24	604217.4
			604218.1	604218	14	14	22x1,5	22x1,5	30	22	35	40	19	27	27	604218.4
			604219.1	604219	16	16	24x1,5	24x1,5	33	24,5	36,5	43	24	30	30	604219.4
	420	400	604220.1	604220	20	20	30x2	30x2	37	26,5	44,5	48	27	36	36	604220.4
			604221.1	604221	25	25	36x2	36x2	42	30	50	54	36	46	46	604221.4
			604222.1	604222	30	30	42x2	42x2	49	35,5	55,5	62	41	50	50	604222.4
			604223.1	604223	38	38	52x2	52x2	57	41	63	72	50	60	60	604223.4
S/L	500	315	604224.1	604224	6 S	6 L	14x1,5	12x1,5	19	12	27	27	12	17	14	604224.4
			604225.1	604225	8 S	8 L	16x1,5	14x1,5	21	14	27,5	29	14	19	17	604225.4
			604226.1	604226	10 S	10 L	18x1,5	16x1,5	24	17	30	32	17	22	19	604226.4
	400		604227.1	604227	12 S	12 L	20x1,5	18x1,5	24	17	31	32	17	24	22	604227.4
L/S	500	315	604228.1	604228	6 L	6 S	12x1,5	14x1,5	23	16	26	31	12	14	17	604228.4
			604229.1	604229	8 L	8 S	14x1,5	16x1,5	24	17	27,5	32	14	17	19	604229.4
			604230.1	604230	10 L	10 S	16x1,5	18x1,5	25	17,5	29,5	34	17	19	22	604230.4
			604231.1	604231	12 L	12 S	18x1,5	20x1,5	29	21,5	30	38	17	22	24	604231.4

Note: If you wish to order a fitting in stainless steel, please change the first two digit from **60....** to **61....** .

ADJUSTABLE MALE STUD ELBOW WITH MALE STUD

Thread BSP Parallel - Thread Metric Parallel

Type: **6043...1** Body
Type: **6044...1** Body

Type: **6043... B3** Ring
Type: **6044... B3** Ring

Type: **6043...4** B4 Ring
Type: **6044...4** B4 Ring

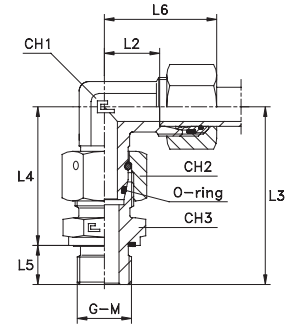
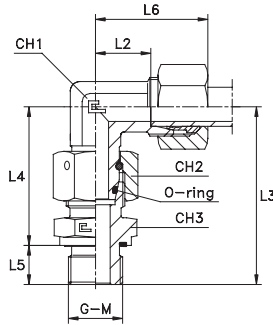
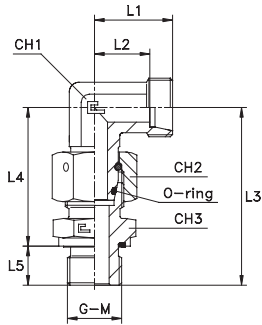

Series DIN	60.... [bar]	61.... [bar]	Ordering Body	Ordering Equipped B3	Ø Tube	G	L1	L2	L3	L4	L5	L6	CH1	CH2	CH3	Ordering Equipped B4
L	500	315	604304.1	604304	6	1/8	19	12	42,5	34,5	8	27	12	14	14	604304.4
			604305.1	604305	8	1/4	21	14	49,5	37,5	12	29	12	17	19	604305.4
			604306.1	604306	10	1/4	22	15	52	40	12	30	14	19	19	604306.4
			604307.1	604307	12	3/8	24	17	54	42	12	32	17	22	22	604307.4
			604308.1	604308	15	1/2	28	21	60,5	46,5	14	36	19	27	27	604308.4
	400	160	604309.1	604309	18	1/2	31	23,5	64	50	14	40	24	32	27	604309.4
			604310.1	604310	22	3/4	35	27,5	71	55	16	44	27	36	32	604310.4
			604311.1	604311	28	1	38	30,5	77	59	18	47	36	41	41	604311.4
			604312.1	604312	35	1 1/4	45	34,5	89	69	20	56	41	50	50	604312.4
			604313.1	604313	42	1 1/2	51	40	97	75	22	63	50	60	55	604313.4
S	800	630	604314.1	604314	6	1/4	23	16	52	40	12	31	12	17	19	604314.4
			604315.1	604315	8	1/4	24	17	54,5	42,5	12	32	14	19	19	604315.4
			604316.1	604316	10	3/8	25	17,5	57,5	45,5	12	34	17	22	22	604316.4
			604317.1	604317	12	3/8	29	21,5	60,5	48,5	12	38	17	24	22	604317.4
	630	400	604318.1	604318	14	1/2	30	22	68	54	14	40	19	27	27	604318.4
			604319.1	604319	16	1/2	33	24,5	69	55	14	43	24	30	27	604319.4
			604320.1	604320	20	3/4	37	26,5	81	65	16	48	27	36	32	604320.4
	420	315	604321.1	604321	25	1	42	30	91	73	18	54	36	46	41	604321.4
			604322.1	604322	30	1 1/4	49	35,5	99	79	20	62	41	50	50	604322.4
			604323.1	604323	38	1 1/2	57	41	111	89	22	72	50	60	55	604323.4

Note: If you wish to order a fitting in stainless steel, please change the first two digit from **60....** to **61....** .

Series DIN	60.... [bar]	61.... [bar]	Ordering Body	Ordering Equipped B3	Ø Tube	M	L1	L2	L3	L4	L5	L6	CH1	CH2	CH3	Ordering Equipped B4
L	500	315	604404.1	604404	6	10x1	19	12	42,5	34,5	8	27	12	14	14	604404.4
			604405.1	604405	8	12x1,5	21	14	49,5	37,5	12	29	12	17	17	604405.4
			604406.1	604406	10	14x1,5	22	15	52	40	12	30	14	19	19	604406.4
			604407.1	604407	12	16x1,5	24	17	54	42	12	32	17	22	22	604407.4
			604408.1	604408	15	18x1,5	28	21	58	46	14	36	19	27	24	604408.4
	400	160	604409.1	604409	18	22x1,5	31	23,5	64	50	14	40	24	32	27	604409.4
			604410.1	604410	22	26x1,5	35	27,5	71	55	16	44	27	36	32	604410.4
			604411.1	604411	28	33x2	38	30,5	77	59	18	47	36	41	41	604411.4
			604412.1	604412	35	42x2	45	34,5	89	69	20	56	41	50	50	604412.4
			604413.1	604413	42	48x2	51	40	97	75	22	63	50	60	55	604413.4
S	800	630	604414.1	604414	6	12x1,5	23	16	52	40	12	31	12	17	17	604414.4
			604415.1	604415	8	14x1,5	24	17	54,5	42,5	12	32	14	19	19	604415.4
			604416.1	604416	10	16x1,5	25	17,5	57,5	45,5	12	34	17	22	22	604416.4
			604417.1	604417	12	18x1,5	29	21,5	60,5	48,5	12	38	17	24	24	604417.4
	630	400	604418.1	604418	14	20x1,5	30	22	68	54	14	40	19	27	27	604418.4
			604419.1	604419	16	22x1,5	33	24,5	69	55	14	43	24	30	27	604419.4
			604420.1	604420	20	27x2	37	26,5	81	65	16	48	27	36	32	604420.4
	420	315	604421.1	604421	25	33x2	42	30	91	73	18	54	36	46	41	604421.4
			604422.1	604422	30	42x2	49	35,5	99	79	20	62	41	50	50	604422.4
			604423.1	604423	38	48x2	57	41	111	89	22	72	50	60	55	604423.4

Note: If you wish to order a fitting in stainless steel, please change the first two digit from **60....** to **61....** .

ADJUSTABLE MALE STUD BARREL TEE

Type: **6046...1** Body

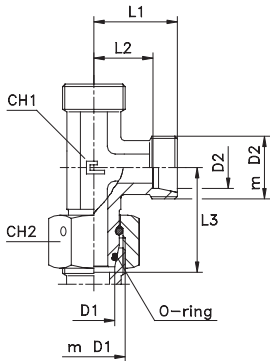

Type: **6046.. B3** Ring

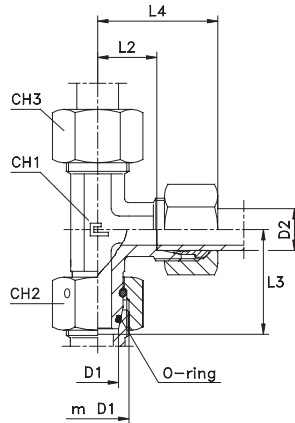

Type: **6046...4** B4 Ring

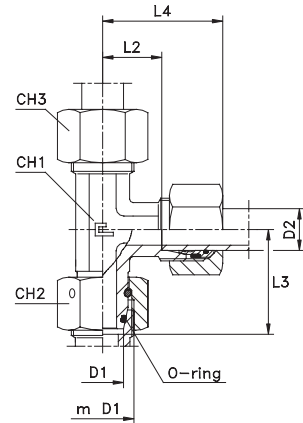

Series DIN	60.... [bar]	61.... [bar]	Ordering Body	Ordering Equipped B3	Ø Tube		m D1	m D2	L1	L2	L3	L4	CH1	CH2	CH3	Ordering Equipped B4
					D1	D2										
L	500	315	604604.1	604604	6	6	12x1,5	12x1,5	19	12	26	27	12	14	14	604604.4
			604605.1	604605	8	8	14x1,5	14x1,5	21	14	27,5	29	12	17	17	604605.4
			604606.1	604606	10	10	16x1,5	16x1,5	22	15	29	30	14	19	19	604606.4
			604607.1	604607	12	12	18x1,5	18x1,5	24	17	29,5	32	17	22	22	604607.4
			604608.1	604608	15	15	22x1,5	22x1,5	28	21	32,5	36	19	27	27	604608.4
	604609.1	604609	18	18	26x1,5	26x1,5	31	23,5	35,5	40	24	32	32	604609.4		
	604610.1	604610	22	22	30x2	30x2	35	27,5	38,5	44	27	36	36	604610.4		
	604611.1	604611	28	28	36x2	36x2	38	30,5	41,5	47	36	41	41	604611.4		
	604612.1	604612	35	35	45x2	45x2	45	34,5	51,5	56	41	50	50	604612.4		
604613.1	604613	42	42	52x2	52x2	51	40	56	63	50	60	60	604613.4			
S	800	630	604614.1	604614	6	6	14x1,5	14x1,5	23	16	27	31	12	17	17	604614.4
			604615.1	604615	8	8	16x1,5	16x1,5	24	17	27,5	32	14	19	19	604615.4
			604616.1	604616	10	10	18x1,5	18x1,5	25	17,5	30,5	34	17	22	22	604616.4
			604617.1	604617	12	12	20x1,5	20x1,5	29	21,5	31,5	38	17	24	24	604617.4
	604618.1	604618	14	14	22x1,5	22x1,5	30	22	35	40	19	27	27	604618.4		
	604619.1	604619	16	16	24x1,5	24x1,5	33	24,5	36,5	43	24	30	30	604619.4		
	420	400	604620.1	604620	20	20	30x2	30x2	37	26,5	44,5	48	27	36	36	604620.4
			604621.1	604621	25	25	36x2	36x2	42	30	50	54	36	46	46	604621.4
			604622.1	604622	30	30	42x2	42x2	49	35,5	55,5	62	41	50	50	604622.4
604623.1			604623	38	38	52x2	52x2	57	41	63	72	50	60	60	604623.4	
604624.1			604624	6 S	6 L	14x1,5	12x1,5	19	12	27	27	12	17	14	604624.4	
S/L	500	315	604625.1	604625	8 S	8 L	16x1,5	14x1,5	21	14	27,5	29	14	19	17	604625.4
			604626.1	604626	10 S	10 L	18x1,5	16x1,5	24	17	30	32	17	22	19	604626.4
			604627.1	604627	12 S	12 L	20x1,5	18x1,5	24	17	31	32	17	24	22	604627.4
L/S	500	315	604628.1	604628	6 L	6 S	12x1,5	14x1,5	23	16	26	31	12	14	17	604628.4
			604629.1	604629	8 L	8 S	14x1,5	16x1,5	24	17	27,5	32	14	17	19	604629.4
			604630.1	604630	10 L	10 S	16x1,5	18x1,5	25	17,5	29,5	34	17	19	22	604630.4
			604631.1	604631	12 L	12 S	18x1,5	20x1,5	29	21,5	30	38	17	22	24	604631.4

Note: If you wish to order a fitting in stainless steel, please change the first two digit from **60....** to **61....** .

ADJUSTABLE MALE STUD BARREL TEE WITH MALE STUD

Thread BSP Parallel - Thread Metric Parallel

Type: **6047...1** Body
Type: **6048...1** Body

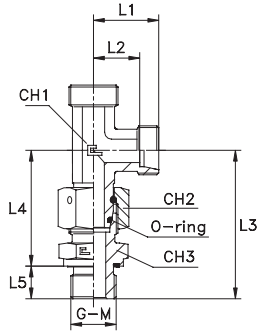

Type: **6047... B3** Ring
Type: **6048... B3** Ring

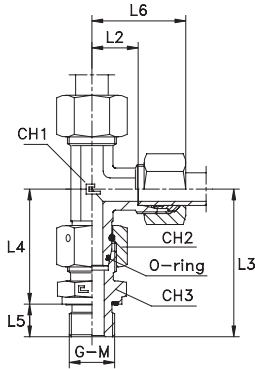

Type: **6047...4** B4 Ring
Type: **6048...4** B4 Ring

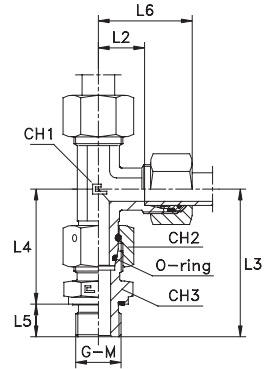

Series DIN	60.... [bar]	61.... [bar]	Ordering Body	Ordering Equipped B3	Ø Tube	G	L1	L2	L3	L4	L5	L6	CH1	CH2	CH3	Ordering Equipped B4
L	500	315	604704.1	604704	6	1/8	19	12	42,5	34,5	8	27	12	14	14	604704.4
			604705.1	604705	8	1/4	21	14	49,5	37,5	12	29	12	17	19	604705.4
			604706.1	604706	10	1/4	22	15	52	40	12	30	14	19	19	604706.4
			604707.1	604707	12	3/8	24	17	54	42	12	32	17	22	22	604707.4
			604708.1	604708	15	1/2	28	21	60,5	46,5	14	36	19	27	27	604708.4
	400	160	604709.1	604709	18	1/2	31	23,5	64	50	14	40	24	32	27	604709.4
			604710.1	604710	22	3/4	35	27,5	71	55	16	44	27	36	32	604710.4
			604711.1	604711	28	1	38	30,5	77	59	18	47	36	41	41	604711.4
			604712.1	604712	35	1 1/4	45	34,5	89	69	20	56	41	50	50	604712.4
			604713.1	604713	42	1 1/2	51	40	97	75	22	63	50	60	55	604713.4
S	800	630	604714.1	604714	6	1/4	23	16	52	40	12	31	12	17	19	604714.4
			604715.1	604715	8	1/4	24	17	54,5	42,5	12	32	14	19	19	604715.4
			604716.1	604716	10	3/8	25	17,5	57,5	45,5	12	34	17	22	22	604716.4
			604717.1	604717	12	3/8	29	21,5	60,5	48,5	12	38	17	24	22	604717.4
	630	400	604718.1	604718	14	1/2	30	22	68	54	14	40	19	27	27	604718.4
			604719.1	604719	16	1/2	33	24,5	69	55	14	43	24	30	27	604719.4
			604720.1	604720	20	3/4	37	26,5	81	65	16	48	27	36	32	604720.4
	420	315	604721.1	604721	25	1	42	30	91	73	18	54	36	46	41	604721.4
			604722.1	604722	30	1 1/4	49	35,5	99	79	20	62	41	50	50	604722.4
			604723.1	604723	38	1 1/2	57	41	111	89	22	72	50	60	55	604723.4

Note: If you wish to order a fitting in stainless steel, please change the first two digit from **60....** to **61....** .

Series DIN	60.... [bar]	61.... [bar]	Ordering Body	Ordering Equipped B3	Ø Tube	M	L1	L2	L3	L4	L5	L6	CH1	CH2	CH3	Ordering Equipped B4
L	500	315	604804.1	604804	6	10x1	8	34,5	42,5	34,5	8	27	12	14	14	604804.4
			604805.1	604805	8	12x1,5	12	37	49,5	37,5	12	29	12	17	17	604805.4
			604806.1	604806	10	14x1,5	12	39,5	52	40	12	30	14	19	19	604806.4
			604807.1	604807	12	16x1,5	12	41,5	54	42	12	32	17	22	22	604807.4
			604808.1	604808	15	18x1,5	14	45,5	58	46	14	36	19	27	24	604808.4
	400	160	604809.1	604809	18	22x1,5	14	49,5	64	50	14	40	24	32	27	604809.4
			604810.1	604810	22	26x1,5	16	54,5	71	55	16	44	27	36	32	604810.4
			604811.1	604811	28	33x2	18	59	77	59	18	47	36	41	41	604811.4
			604812.1	604812	35	42x2	20	68,5	89	69	20	56	41	50	50	604812.4
			604813.1	604813	42	48x2	22	75	97	75	22	63	50	60	55	604813.4
S	800	630	604814.1	604814	6	12x1,5	12	40	52	40	12	31	12	17	17	604814.4
			604815.1	604815	8	14x1,5	12	42	54,5	42,5	12	32	14	19	19	604815.4
			604816.1	604816	10	16x1,5	12	44,5	57,5	45,5	12	34	17	22	22	604816.4
			604817.1	604817	12	18x1,5	12	47,5	60,5	48,5	12	38	17	24	24	604817.4
	630	400	604818.1	604818	14	20x1,5	14	53,5	68	54	14	40	19	27	27	604818.4
			604819.1	604819	16	22x1,5	14	54,5	69	55	14	43	24	30	27	604819.4
			604820.1	604820	20	27x2	16	64,5	81	65	16	48	27	36	32	604820.4
	420	315	604821.1	604821	25	33x2	18	72,5	91	73	18	54	36	46	41	604821.4
			604822.1	604822	30	42x2	20	78,5	99	79	20	62	41	50	50	604822.4
			604823.1	604823	38	48x2	22	89	111	89	22	72	50	60	55	604823.4

Note: If you wish to order a fitting in stainless steel, please change the first two digit from **60....** to **61....** .

ADJUSTABLE MALE STUD BRANCH TEE

Type: **6050...1** Body

Type: **6050..** B3 Ring

Type: **6050...4** B4 Ring

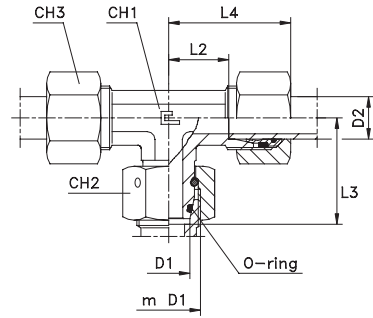
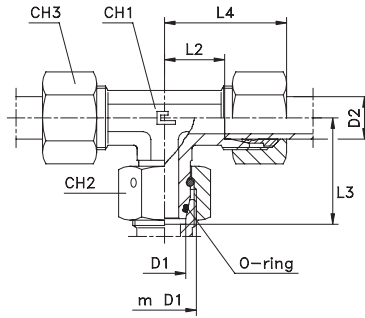
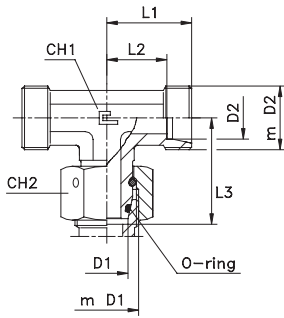

Series DIN	60.... [bar]	61.... [bar]	Ordering Body	Ordering Equipped B3	Ø Tube D1 D2	m D1	m D2	L1	L2	L3	L4	CH1	CH2	CH3	Ordering Equipped B4		
L	500	315	605004.1	605004	6 6	12x1,5	12x1,5	19	12	26	27	12	14	14	605004.4		
			605005.1	605005	8 8	14x1,5	14x1,5	21	14	27,5	29	12	17	17	605005.4		
			605006.1	605006	10 10	16x1,5	16x1,5	22	15	29	30	14	19	19	605006.4		
	400		605007.1	605007	12 12	18x1,5	18x1,5	24	17	29,5	32	17	22	22	605007.4		
			605008.1	605008	15 15	22x1,5	22x1,5	28	21	32,5	36	19	27	27	605008.4		
			605009.1	605009	18 18	26x1,5	26x1,5	31	23,5	35,5	40	24	32	32	605009.4		
	250		605010.1	605010	22 22	30x2	30x2	35	27,5	38,5	44	27	36	36	605010.4		
			605011.1	605011	28 28	36x2	36x2	38	30,5	41,5	47	36	41	41	605011.4		
			605012.1	605012	35 35	45x2	45x2	45	34,5	51,5	56	41	50	50	605012.4		
			605013.1	605013	42 42	52x2	52x2	51	40	56	63	50	60	605013.4			
S	800	630	605014.1	605014	6 6	14x1,5	14x1,5	23	16	27	31	12	17	17	605014.4		
			605015.1	605015	8 8	16x1,5	16x1,5	24	17	27,5	32	14	19	19	605015.4		
			605016.1	605016	10 10	18x1,5	18x1,5	25	17,5	30,5	34	17	22	22	605016.4		
	630		605017.1	605017	12 12	20x1,5	20x1,5	29	21,5	31,5	38	17	24	24	605017.4		
			605018.1	605018	14 14	22x1,5	22x1,5	30	22	35	40	19	27	27	605018.4		
			605019.1	605019	16 16	24x1,5	24x1,5	33	24,5	36,5	43	24	30	30	605019.4		
	420		605020.1	605020	20 20	30x2	30x2	37	26,5	44,5	48	27	36	36	605020.4		
			605021.1	605021	25 25	36x2	36x2	42	30	50	54	36	46	46	605021.4		
			605022.1	605022	30 30	42x2	42x2	49	35,5	55,5	62	41	50	50	605022.4		
					605023.1	605023	38 38	52x2	52x2	57	41	63	72	50	60	605023.4	
	S/L		500	315	605024.1	605024	6 S 6 L	14x1,5	12x1,5	19	12	27	27	12	17	14	605024.4
					605025.1	605025	8 S 8 L	16x1,5	14x1,5	21	14	27,5	29	14	19	17	605025.4
605026.1		605026			10 S 10 L	18x1,5	16x1,5	24	17	30	32	17	22	19	605026.4		
	400		605027.1	605027	12 S 12 L	20x1,5	18x1,5	24	17	31	32	17	24	22	605027.4		
L/S	500	315	605028.1	605028	6 L 6 S	12x1,5	14x1,5	23	16	26	31	12	14	17	605028.4		
			605029.1	605029	8 L 8 S	14x1,5	16x1,5	24	17	27,5	32	14	17	19	605029.4		
			605030.1	605030	10 L 10 S	16x1,5	18x1,5	25	17,5	29,5	34	17	19	22	605030.4		
			605031.1	605031	12 L 12 S	18x1,5	20x1,5	29	21,5	30	38	17	22	24	605031.4		

Note: If you wish to order a fitting in stainless steel, please change the first two digit from **60....** to **61....** .

ADJUSTABLE MALE STUD BRANCH TEE WITH MALE STUD

Thread BSP Parallel - Thread Metric Parallel

Type: **6051...1** Body
Type: **6052...1** Body

Type: **6051.. B3** Ring
Type: **6052.. B3** Ring

Type: **6051...4 B4** Ring
Type: **6052...4 B4** Ring

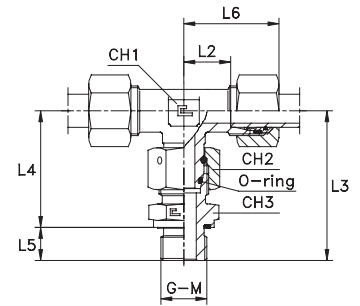
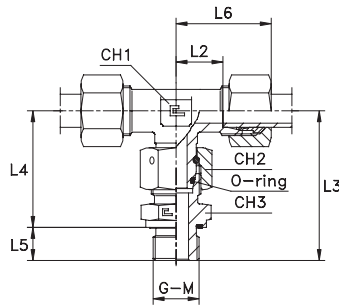
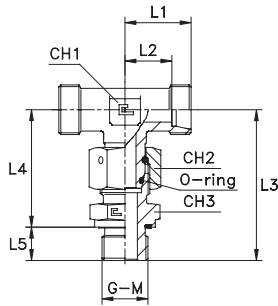

Series DIN	60.... [bar]	61.... [bar]	Ordering Body	Ordering Equipped B3	Ø Tube	G	L1	L2	L3	L4	L5	L6	CH1	CH2	CH3	Ordering Equipped B4
L	500	315	605104.1	605104	6	1/8	19	12	42,5	34,5	8	27	12	14	14	605104.4
			605105.1	605105	8	1/4	21	14	49,5	37,5	12	29	12	17	19	605105.4
			605106.1	605106	10	1/4	22	15	52	40	12	30	14	19	19	605106.4
			605107.1	605107	12	3/8	24	17	54	42	12	32	17	22	22	605107.4
			605108.1	605108	15	1/2	28	21	60,5	46,5	14	36	19	27	27	605108.4
	400	160	605109.1	605109	18	1/2	31	23,5	64	50	14	40	24	32	27	605109.4
			605110.1	605110	22	3/4	35	27,5	71	55	16	44	27	36	32	605110.4
			605111.1	605111	28	1	38	30,5	77	59	18	47	36	41	41	605111.4
			605112.1	605112	35	1 1/4	45	34,5	89	69	20	56	41	50	50	605112.4
			605113.1	605113	42	1 1/2	51	40	97	75	22	63	50	60	55	605113.4
S	800	630	605114.1	605114	6	1/4	23	16	52	40	12	31	12	17	19	605114.4
			605115.1	605115	8	1/4	24	17	54,5	42,5	12	32	14	19	19	605115.4
			605116.1	605116	10	3/8	25	17,5	57,5	45,5	12	34	17	22	22	605116.4
			605117.1	605117	12	3/8	29	21,5	60,5	48,5	12	38	17	24	22	605117.4
			605118.1	605118	14	1/2	30	22	68	54	14	40	19	27	27	605118.4
	630	400	605119.1	605119	16	1/2	33	24,5	69	55	14	43	24	30	27	605119.4
			605120.1	605120	20	3/4	37	26,5	81	65	16	48	27	36	32	605120.4
			605121.1	605121	25	1	42	30	91	73	18	54	36	46	41	605121.4
			605122.1	605122	30	1 1/4	49	35,5	99	79	20	62	41	50	50	605122.4
			605123.1	605123	38	1 1/2	57	41	111	89	22	72	50	60	55	605123.4

Note: If you wish to order a fitting in stainless steel, please change the first two digit from **60....** to **61....** .

Series DIN	60.... [bar]	61.... [bar]	Ordering Body	Ordering Equipped B3	Ø Tube	M	L1	L2	L3	L4	L5	L6	CH1	CH2	CH3	Ordering Equipped B4
L	500	315	605204.1	605204	6	10x1	19	12	42,5	34,5	8	27	12	14	14	605204.4
			605205.1	605205	8	12x1,5	21	14	49,5	37,5	12	29	12	17	17	605205.4
			605206.1	605206	10	14x1,5	22	15	52	40	12	30	14	19	19	605206.4
			605207.1	605207	12	16x1,5	24	17	54	42	12	32	17	22	22	605207.4
			605208.1	605208	15	18x1,5	28	21	58	46	14	36	19	27	24	605208.4
	400	160	605209.1	605209	18	22x1,5	31	23,5	64	50	14	40	24	32	27	605209.4
			605210.1	605210	22	26x1,5	35	27,5	71	55	16	44	27	36	32	605210.4
			605211.1	605211	28	33x2	38	30,5	77	59	18	47	36	41	41	605211.4
			605212.1	605212	35	42x2	45	34,5	89	69	20	56	41	50	50	605212.4
			605213.1	605213	42	48x2	51	40	97	75	22	63	50	60	55	605213.4
S	800	630	605214.1	605214	6	12x1,5	23	16	52	40	12	31	12	17	17	605214.4
			605215.1	605215	8	14x1,5	24	17	54,5	42,5	12	32	14	19	19	605215.4
			605216.1	605216	10	16x1,5	25	17,5	57,5	45,5	12	34	17	22	22	605216.4
			605217.1	605217	12	18x1,5	29	21,5	60,5	48,5	12	38	17	24	24	605217.4
			605218.1	605218	14	20x1,5	30	22	68	54	14	40	19	27	27	605218.4
	630	400	605219.1	605219	16	22x1,5	33	24,5	69	55	14	43	24	30	27	605219.4
			605220.1	605220	20	27x2	37	26,5	81	65	16	48	27	36	32	605220.4
			605221.1	605221	25	33x2	42	30	91	73	18	54	36	46	41	605221.4
			605222.1	605222	30	42x2	49	35,5	99	79	20	62	41	50	50	605222.4
			605223.1	605223	38	48x2	57	41	111	89	22	72	50	60	55	605223.4

Note: If you wish to order a fitting in stainless steel, please change the first two digit from **60....** to **61....** .

REDUCING TUBE ADAPTER WITH SWIVEL NUT L SERIES

Type: **6053...1** Body

Type: **6053.. B3** Ring

Type: **6053...4** B4 Ring

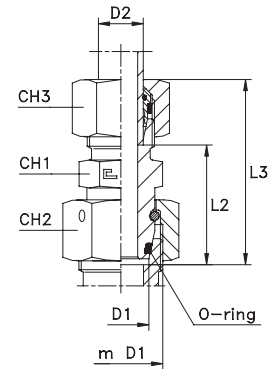
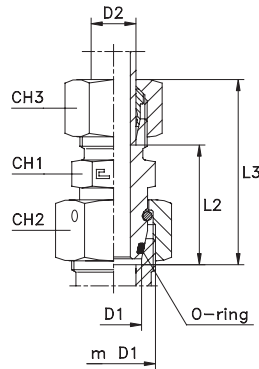
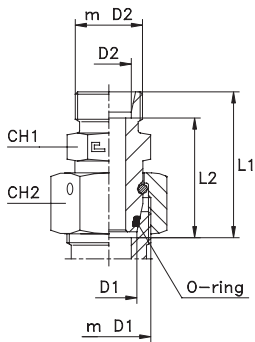

Series DIN	60.... [bar]	61.... [bar]	Ordering Body	Ordering Equipped B3	Ø Tube		m D1	m D2	L1	L2	L3	CH1	CH2	CH3	Ordering Equipped B4
					D1	D2									
L	500	315	605301.1	605301	8	6	14x1,5	12X1,5	31	24	39	12	17	14	605301.4
			605302.1	605302	10	6	16x1,5	12X1,5	32,5	25,5	40,5	14	19	14	605302.4
	605303.1		605303	12	6	18x1,5	12X1,5	32,5	25,5	40,5	17	22	14	605303.4	
	605304.1		605304	15	6	22x1,5	12X1,5	35,5	28,5	43,5	19	27	14	605304.4	
	400	160	605305.1	605305	18	6	26x1,5	12X1,5	36,5	29,5	44,5	24	32	14	605305.4
			605306.1	605306	22	6	30x2	12X1,5	38,5	31,5	46,5	27	36	14	605306.4
			605307.1	605307	28	6	36x2	12X1,5	39,5	32,5	47,5	32	41	14	605307.4
			605308.1	605308	35	6	45x2	12X1,5	45	38	53	41	50	14	605308.4
	250	315	605309.1	605309	42	6	52x2	12X1,5	46	39	54	50	60	14	605309.4
			605310.1	605310	10	8	16x1,5	14X1,5	32,5	25,5	40,5	14	19	17	605310.4
			605311.1	605311	12	8	18x1,5	14X1,5	32,5	25,5	40,5	17	22	17	605311.4
			605312.1	605312	15	8	22x1,5	14X1,5	35,5	28,5	43,5	19	27	17	605312.4
	250	160	605313.1	605313	18	8	26x1,5	14X1,5	36,5	29,5	44,5	24	32	17	605313.4
			605314.1	605314	22	8	30x2	14X1,5	38,5	31,5	46,5	27	36	17	605314.4
			605315.1	605315	28	8	36x2	14X1,5	39,5	32,5	47,5	32	41	17	605315.4
			605316.1	605316	35	8	45x2	14X1,5	45	38	53	41	50	17	605316.4
	400	315	605317.1	605317	42	8	52x2	14X1,5	46	39	54	50	60	17	605317.4
			605318.1	605318	12	10	18x1,5	16X1,5	33,5	26,5	41,5	17	22	19	605318.4
			605319.1	605319	15	10	22x1,5	16X1,5	36,5	29,5	44,5	19	27	19	605319.4
			605320.1	605320	18	10	26x1,5	16X1,5	37,5	30,5	45,5	24	32	19	605320.4
	250	160	605321.1	605321	22	10	30x2	16X1,5	39,5	32,5	47,5	27	36	19	605321.4
			605322.1	605322	28	10	36x2	16X1,5	40,5	33,5	48,5	32	41	19	605322.4
			605323.1	605323	35	10	45x2	16X1,5	46	39	54	41	50	19	605323.4
			605324.1	605324	42	10	52x2	16X1,5	47	40	55	50	60	19	605324.4
	400	315	605325.1	605325	15	12	22x1,5	18X1,5	36,5	29,5	44,5	19	27	22	605325.4
			605326.1	605326	18	12	26x1,5	18X1,5	37,5	30,5	45,5	24	32	22	605326.4
			605327.1	605327	22	12	30x2	18X1,5	39,5	32,5	47,5	27	36	22	605327.4
			605328.1	605328	28	12	36x2	18X1,5	40,5	33,5	48,5	32	41	22	605328.4
	250	160	605329.1	605329	35	12	45x2	18X1,5	46	39	54	41	50	22	605329.4
			605330.1	605330	42	12	52x2	18X1,5	47	40	55	50	60	22	605330.4
			605331.1	605331	18	15	26x1,5	22X1,5	38,5	31,5	46,5	24	32	27	605331.4
			605332.1	605332	22	15	30x2	22X1,5	39,5	32,5	47,5	27	36	27	605332.4
	250	160	605333.1	605333	28	15	36x2	22X1,5	41,5	34,5	49,5	32	41	27	605333.4
			605334.1	605334	35	15	45x2	22X1,5	47	40	55	41	50	27	605334.4
			605335.1	605335	42	15	52x2	22X1,5	48	41	56	50	60	27	605335.4
			605336.1	605336	22	18	30x2	26X1,5	40,5	33	49,5	27	36	32	605336.4
			605337.1	605337	28	18	36x2	26X1,5	41,5	34	50,5	32	41	32	605337.4
			605338.1	605338	35	18	45x2	26X1,5	47	39,5	56	41	50	32	605338.4
			605339.1	605339	42	18	52x2	26X1,5	48	40,5	57	50	60	32	605339.4
			605340.1	605340	28	22	36x2	30X2	43,5	36	52,5	32	41	36	605340.4
605341.1			605341	35	22	45x2	30X2	49	41,5	58	41	50	36	605341.4	
605342.1			605342	42	22	52x2	30X2	50	42,5	59	50	60	36	605342.4	
605343.1			605343	35	28	45x2	36X2	49	41,5	58	41	50	41	605343.4	
605344.1			605344	42	28	52x2	36X2	50	42,5	59	50	60	41	605344.4	
605345.1	605345	42	35	52x2	45X2	52	41,5	63	50	60	50	605345.4			
L/S	500	315	605346.1	605346	8	6	14x1,5	14x1,5	35	28	43	14	17	17	605346.4
			605347.1	605347	10	6	16x1,5	14x1,5	35,5	28,5	43,5	14	19	17	605347.4
	400		605348.1	605348	10	8	16x1,5	16x1,5	37,5	30,5	45,5	17	19	19	605348.4
			605349.1	605349	12	8	18x1,5	16x1,5	37,5	30,5	45,5	17	22	19	605349.4
			605350.1	605350	12	10	18x1,5	18x1,5	37,5	30	46,5	19	22	22	605350.4
			605351.1	605351	15	12	22x1,5	20x1,5	41,5	34	50,5	22	27	24	605351.4

Note: If you wish to order a fitting in stainless steel, please change the first two digit from 60.... to 61....

REDUCING TUBE ADAPTER WITH SWIVEL NUT S SERIES

Type: 6054...1 Body

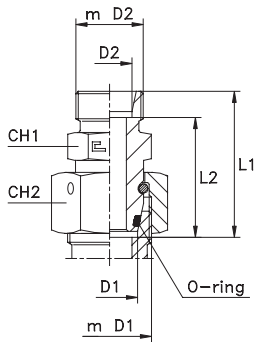

Type: 6054... B3 Ring

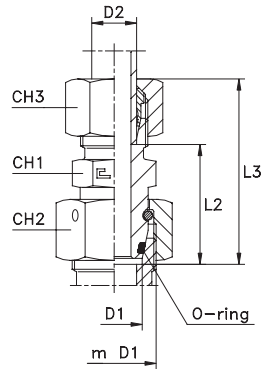

Type: 6054...4 B4 Ring

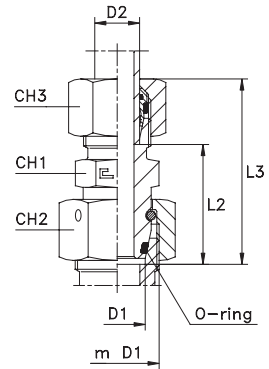

Series DIN	60.... [bar]	61.... [bar]	Ordering Body	Ordering Equipped B3	Ø Tube		m D1	m D2	L1	L2	L3	CH1	CH2	CH3	Ordering Equipped B4
					D1	D2									
S	800	630	605401.1	605401	8	6	16x1,5	14x1,5	36	29	44	14	19	17	605401.4
			605402.1	605402	10	6	18x1,5	14x1,5	39	32	47	17	22	17	605402.4
	630	630	605403.1	605403	12	6	20x1,5	14x1,5	38,5	31,5	46,5	17	24	17	605403.4
			605404.1	605404	14	6	22x1,5	14x1,5	41	34	49	19	27	17	605404.4
	420	400	605405.1	605405	16	6	24x1,5	14x1,5	45,5	38,5	53,5	22	30	17	605405.4
			605406.1	605406	20	6	30x2	14x1,5	48	41	56	27	36	17	605406.4
	315	400	605407.1	605407	25	6	36x2	14x1,5	52,5	45,5	60,5	32	46	17	605407.4
			605408.1	605408	30	6	42x2	14x1,5	57	50	65	41	50	17	605408.4
	800	630	605409.1	605409	38	6	52x2	14x1,5	59	52	67	50	60	17	605409.4
			605410.1	605410	10	8	18x1,5	16x1,5	38,5	31,5	46,5	17	22	19	605410.4
	630	630	605411.1	605411	12	8	20x1,5	16x1,5	38,5	31,5	46,5	17	24	19	605411.4
			605412.1	605412	14	8	22x1,5	16x1,5	41	34	49	19	27	19	605412.4
	420	400	605413.1	605413	16	8	24x1,5	16x1,5	45,5	38,5	53,5	22	30	19	605413.4
			605414.1	605414	20	8	30x2	16x1,5	48	41	56	27	36	19	605414.4
	315	400	605415.1	605415	25	8	36x2	16x1,5	52,5	45,5	60,5	32	46	19	605415.4
			605416.1	605416	30	8	42x2	16x1,5	57	50	65	41	50	19	605416.4
	630	630	605417.1	605417	38	8	52x2	16x1,5	59	52	67	50	60	19	605417.4
			605418.1	605418	12	10	20x1,5	18x1,5	38,5	31	47,5	19	24	22	605418.4
	420	400	605419.1	605419	14	10	22x1,5	18x1,5	41	33,5	50	19	27	22	605419.4
			605420.1	605420	16	10	24x1,5	18x1,5	45,5	38	54,5	22	30	22	605420.4
	630	630	605421.1	605421	20	10	30x2	18x1,5	48	40,5	57	27	36	22	605421.4
			605422.1	605422	25	10	36x2	18x1,5	52,5	45	61,5	32	46	22	605422.4
	420	250	605423.1	605423	30	10	42x2	18x1,5	57	49,5	66	41	50	22	605423.4
			605424.1	605424	38	10	52x2	18x1,5	59	51,5	68	50	60	22	605424.4
	630	630	605425.1	605425	14	12	22x1,5	20x1,5	43	35,5	52	22	27	24	605425.4
			605426.1	605426	16	12	24x1,5	20x1,5	45,5	38	54,5	22	30	24	605426.4
	420	400	605427.1	605427	20	12	30x2	20x1,5	48	40,5	57	27	36	24	605427.4
			605428.1	605428	25	12	36x2	20x1,5	52,5	45	61,5	32	46	24	605428.4
	630	630	605429.1	605429	30	12	42x2	20x1,5	57	49,5	66	41	50	24	605429.4
			605430.1	605430	38	12	52x2	20x1,5	59	51,5	68	50	60	24	605430.4
	420	400	605431.1	605431	16	14	24x1,5	22x1,5	47,5	39,5	57,5	24	30	27	605431.4
			605432.1	605432	20	14	30x2	22x1,5	50	42	60	27	36	27	605432.4
630	630	605433.1	605433	25	14	36x2	22x1,5	54,5	46,5	64,5	32	46	27	605433.4	
		605434.1	605434	30	14	42x2	22x1,5	59	51	69	41	50	27	605434.4	
420	250	605435.1	605435	38	14	52x2	22x1,5	61	53	71	50	60	27	605435.4	
		605436.1	605436	20	16	30x2	24x1,5	50	41,5	60	27	36	30	605436.4	
630	630	605437.1	605437	25	16	36x2	24x1,5	54,5	46	64,5	32	46	30	605437.4	
		605438.1	605438	30	16	42x2	24x1,5	59	50,5	69	41	50	30	605438.4	
420	400	605439.1	605439	38	16	52x2	24x1,5	61	52,5	71	50	60	30	605439.4	
		605440.1	605440	25	20	36x2	30x2	56,5	46	67,5	32	46	36	605440.4	
630	630	605441.1	605441	30	20	42x2	30x2	61	50,5	72	41	50	36	605441.4	
		605442.1	605442	38	20	52x2	30x2	63	52,5	74	50	60	36	605442.4	
420	400	605443.1	605443	30	25	42x2	36x2	63	51	75	41	50	46	605443.4	
		605444.1	605444	38	25	52x2	36x2	65	53	77	50	60	46	605444.4	
630	630	605445.1	605445	38	30	52x2	42x2	67	53,5	80	50	60	50	605445.4	
		605446.1	605446	8	6	16x1,5	12x1,5	34	27	42	14	19	14	605446.4	
S/L	500	315	605447.1	605447	10	6	18x1,5	12x1,5	37	30	45	17	22	14	605447.4
			605448.1	605448	10	8	18x1,5	14x1,5	37	30	45	17	22	17	605448.4
400	400	605449.1	605449	12	8	20x1,5	14x1,5	36,5	29,5	44,5	17	24	17	605449.4	
		605450.1	605450	12	10	20x1,5	16x1,5	37,5	30,5	45,5	17	24	19	605450.4	
630	630	605451.1	605451	16	12	24x1,5	18x1,5	44,5	37,5	52,5	22	30	22	605451.4	

Note: If you wish to order a fitting in stainless steel, please change the first two digit from 60.... to 61....

ADJUSTABLE MALE 45° STUD ELBOW

Type: **6055...1** Body

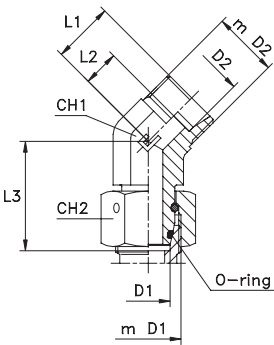

Type: **6055.. B3** Ring

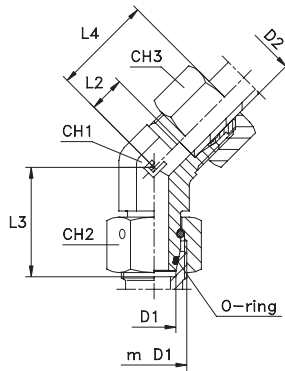

Type: **6055...4** B4 Ring

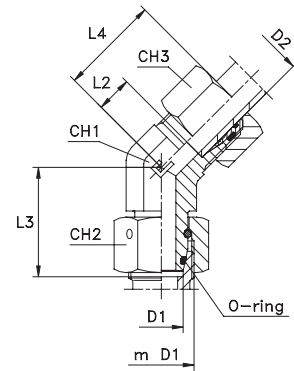

Series DIN	60.... [bar]	61.... [bar]	Ordering Body	Ordering Equipped B3	Ø Tube		m D1	m D2	L1	L2	L3	L4	CH1	CH2	CH3	Ordering Equipped B4
					D1	D2										
L	315	315	605504.1	605504	6	6	12x1,5	12x1,5	16	9	26	24	11	14	14	605504.4
			605505.1	605505	8	8	14x1,5	14x1,5	17	10	27,5	25	14	17	17	605505.4
			605506.1	605506	10	10	16x1,5	16x1,5	18	11	29	26	14	19	19	605506.4
			605507.1	605507	12	12	18x1,5	18x1,5	19	12	29,5	27	19	22	22	605507.4
			605508.1	605508	15	15	22x1,5	22x1,5	22	15	32,5	30	22	27	27	605508.4
	605509.1	605509	18	18	26x1,5	26x1,5	24	16,5	35,5	33	27	32	32	605509.4		
	605510.1	605510	22	22	30x2	30x2	26	18,5	38,5	35	27	36	36	605510.4		
	605511.1	605511	28	28	36x2	36x2	30,5	23	41,5	39,5	33	41	41	605511.4		
	605512.1	605512	35	35	45x2	45x2	34	23,5	51,5	45	41	50	50	605512.4		
	605513.1	605513	42	42	52x2	52x2	37	26	53	49	48	60	60	605513.4		
S	630	630	605514.1	605514	6	6	14x1,5	14x1,5	18	11	27	26	14	17	17	605514.4
			605515.1	605515	8	8	16x1,5	16x1,5	19	12	27,5	27	14	19	19	605515.4
			605516.1	605516	10	10	18x1,5	18x1,5	20	12,5	30,5	29	19	22	22	605516.4
			605517.1	605517	12	12	20x1,5	20x1,5	23	15,5	31,5	32	19	24	24	605517.4
			605518.1	605518	14	14	22x1,5	22x1,5	24	16	35	34	22	27	27	605518.4
	605519.1	605519	16	16	24x1,5	24x1,5	24	15,5	36,5	34	27	30	30	605519.4		
	605520.1	605520	20	20	30x2	30x2	26,5	16	44,5	37,5	27	36	36	605520.4		
	605521.1	605521	25	25	36x2	36x2	32	20	50	44	33	46	46	605521.4		
	605522.1	605522	30	30	42x2	42x2	37,5	24	55,5	50,5	41	50	50	605522.4		
	605523.1	605523	38	38	52x2	52x2	40	24	58	55	48	60	60	605523.4		
S/L	315	315	605524.1	605524	6 S	6 L	14x1,5	12x1,5	16	9	27	24	14	17	14	605524.4
			605525.1	605525	8 S	8 L	16x1,5	14x1,5	17	10	27,5	25	14	19	17	605525.4
			605526.1	605526	10 S	10 L	18x1,5	16x1,5	18	11	30	26	19	22	19	605526.4
			605527.1	605527	12 S	12 L	20x1,5	18x1,5	19	12	31	27	19	24	22	605527.4
L/S	315	315	605528.1	605528	6 L	6 S	12x1,5	14x1,5	18	11	26	26	14	14	17	605528.4
			605529.1	605529	8 L	8 S	14x1,5	16x1,5	19	12	27,5	27	14	17	19	605529.4
			605530.1	605530	10 L	10 S	16x1,5	18x1,5	20	12,5	29,5	29	19	19	22	605530.4
			605531.1	605531	12 L	12 S	18x1,5	20x1,5	23	15,5	30	32	19	22	24	605531.4

Note: If you wish to order a fitting in stainless steel, please change the first two digit from **60....** to **61....** .

GAUGE COUPLING WITH SWIVEL NUT

Thread BSP Parallel

Type: **6060..**

O-ring washer seal

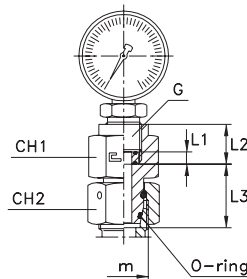

Series DIN	60.... [bar]	61.... [bar]	Ordering Complete	Ø Tube	G	m	L1	L2	L3	CH1	CH2
L	315	315	606004	6	1/4	12x1,5	4,5	14,5	21,5	19	14
			606005	8	1/4	14x1,5	4,5	14,5	21,5	19	17
			606006	10	1/4	16x1,5	4,5	14,5	22	19	19
			606007	12	1/4	18x1,5	4,5	14,5	22	19	22
S	630	630	606014	6	1/2	14x1,5	5	20	23	30	17
			606015	8	1/2	16x1,5	5	20	23,5	30	19
			606016	10	1/2	18x1,5	5	20	24,5	30	22
			606017	12	1/2	20x1,5	5	20	24,5	30	24

Note: If you wish to order a fitting in stainless steel, please change the first two digit from **60....** to **61....** .
Items not included in the ISO 8434-1 Norm available on request only.
Gauge not included.

DISTANCE PIECE ADAPTER WITH SWIVEL NUT

Type: **6061...1** Body

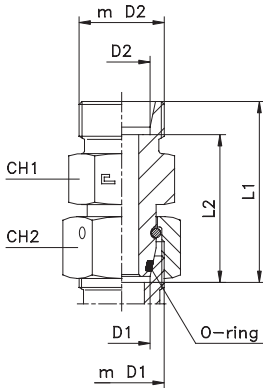

Type: **6061.. B3** Ring

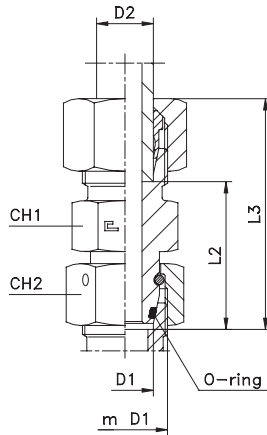

Type: **6061...4** B4 Ring

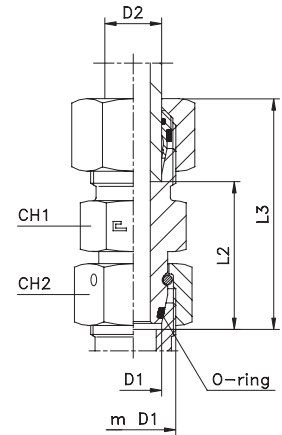

Series DIN	60.... [bar]	61.... [bar]	Ordering Body	Ordering Equipped B3	Ø Tube D1 D2	m D1 m D2	L1	L2	L3	CH1	CH2	Ordering Equipped B4
L	500	315	606104.1	606104	6	12x1,5	43	36	51	12	14	606104.4
			606105.1	606105	8	14x1,5	43	36	51	14	17	606105.4
			606106.1	606106	10	16x1,5	43	36	51	17	19	606106.4
	606107.1		606107	12	18x1,5	43,5	36,5	51,5	19	22	606107.4	
	606108.1		606108	15	22x1,5	43,5	36,5	51,5	24	27	606108.4	
	606109.1		606109	18	26x1,5	44	36,5	53	27	32	606109.4	
	606110.1	606110	22	30x2	47	39,5	56	32	36	606110.4		
	400	606111.1	606111	28	36x2	47	39,5	56	41	41	606111.4	
		606112.1	606112	35	45x2	60	49,5	71	46	50	606112.4	
606113.1		606113	42	52x2	71	60	83	55	60	606113.4		
S	800	630	606114.1	606114	6	14x1,5	43,5	36,5	51,5	14	17	606114.4
			606115.1	606115	8	16x1,5	43,5	36,5	51,5	17	19	606115.4
			606116.1	606116	10	18x1,5	44	36,5	53	19	22	606116.4
	606117.1		606117	12	20x1,5	44	36,5	53	22	24	606117.4	
	606118.1		606118	14	22x1,5	48	40	58	24	27	606118.4	
	606119.1		606119	16	24x1,5	48,5	40	58,5	27	30	606119.4	
	630	606120.1	606120	20	30x2	56	45,5	67	32	36	606120.4	
		606121.1	606121	25	36x2	62	50	74	41	46	606121.4	
		606122.1	606122	30	42x2	69	55,5	82	46	50	606122.4	
	420	606123.1	606123	38	52x2	75,5	59,5	90,5	55	60	606123.4	
		315	606123.1	606123	38	52x2	75,5	59,5	90,5	55	60	606123.4

Note: If you wish to order a fitting in stainless steel, please change the first two digit from **60....** to **61....** .

EQUAL NON RETURN VALVE

Type: **5001...1** Body

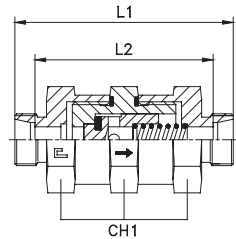

Type: **5001.. B3** Ring

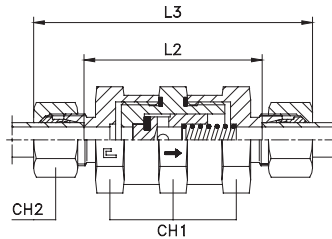

Type: **5001...4** B4 Ring

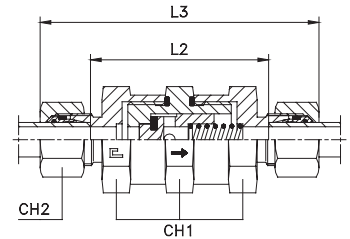

Series DIN	50.... [bar]	51.... [bar]	Ordering Body	Ordering Equipped B3	Ø Tube	L1	L2	L3	CH1	CH2	Ø pass.	Ordering Equipped B4
L	250	250	500104.1	500104	6	68	54	83	19	14	4	500104.4
			500105.1	500105	8	68	54	83	19	17	4	500105.4
			500106.1	500106	10	70	56	85	19	19	4	500106.4
	500107.1		500107	12	76	62	91	32	22	8	500107.4	
	500108.1		500108	15	81	67	97	41	27	11	500108.4	
	500109.1		500109	18	81	66	98	41	32	11	500109.4	
	160	500110.1	500110	22	94	79	111	50	36	18	500110.4	
		500111.1	500111	28	94	79	112	50	41	18	500111.4	
		500112.1	500112	35	116	95	138	70	50	29	500112.4	
100	500113.1	500113	42	116	94	139	70	60	29	500113.4		
	500114.1	500114	6	72	58	87	19	17	4	500114.4		
	500115.1	500115	8	72	58	87	19	19	4	500115.4		
S	400	400	500116.1	500116	10	78	63	95	32	22	7	500116.4
			500117.1	500117	12	78	63	95	32	24	8	500117.4
			500118.1	500118	14	85	69	104	41	27	10	500118.4
			500119.1	500119	16	85	68	104	41	30	11	500119.4
			500120.1	500120	20	98	77	120	50	36	16	500120.4
			500121.1	500121	25	102	78	126	50	46	18	500121.4
	250	500122.1	500122	30	124	97	150	70	50	25	500122.4	
		500123.1	500123	38	128	96	157	70	60	29	500123.4	

Note: If you wish to order AISI 316 stainless steel fittings, please change the first two digits from **50....** to **51....** .
If you wish to order AISI 316 stainless steel fittings with AISI 304 stainless steel nuts, please change the first two digits from **50....** to **54....** .

MALE STUD NON RETURN VALVE WITH ELASTOMER SEAL

Thread BSP Parallel - Thread Metric Parallel

Type: **5002...1** Body
Type: **5003...1** Body

Type: **5002.. B3** Ring
Type: **5003.. B3** Ring

Type: **5002...4** B4 Ring
Type: **5003...4** B4 Ring

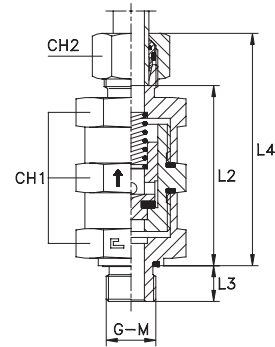
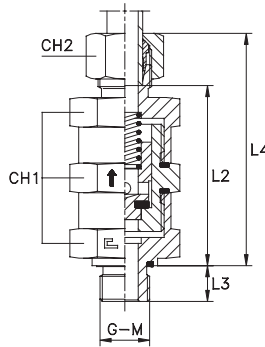
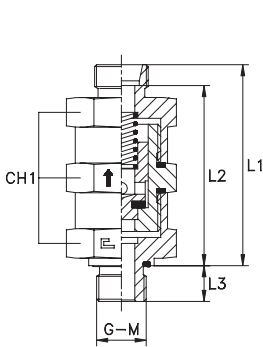

Series DIN	50.... [bar]	51.... [bar]	Ordering Body	Ordering Equipped B3	Ø Tube	G	L1	L2	L3	L4	CH1	CH2	Øpass.	Ordering Equipped B4
L	250	250	500204.1	500204	6	1/8	60	53	8	67,5	19	14	4	500204.4
			500205.1	500205	8	1/4	60	53	12	67,5	19	17	4	500205.4
			500206.1	500206	10	1/4	61	54	12	68,5	19	19	4	500206.4
			500207.1	500207	12	3/8	67,5	60,5	12	75	32	22	8	500207.4
			500208.1	500208	15	1/2	72	65	14	80	41	27	11	500208.4
	160	160	500209.1	500209	18	1/2	72	64,5	14	80,5	41	32	11	500209.4
			500210.1	500210	22	3/4	83	75,5	16	91,5	50	36	16	500210.4
			500211.1	500211	28	1	83	75,5	18	92	50	41	18	500211.4
			500212.1	500212	35	1 1/4	103	92,5	20	114	70	50	25	500212.4
			500213.1	500213	42	1 1/2	103	92	22	114,5	70	60	29	500213.4
S	400	400	500214.1	500214	6	1/4	62	55	12	69,5	19	17	4	500214.4
			500215.1	500215	8	1/4	62	55	12	69,5	19	19	4	500215.4
			500216.1	500216	10	3/8	68,5	61	12	77	32	22	7	500216.4
			500217.1	500217	12	3/8	68,5	61	12	77	32	24	8	500217.4
			500218.1	500218	14	1/2	74	66	14	83,5	41	27	10	500218.4
	250	250	500219.1	500219	16	1/2	74	65,5	14	83,5	41	30	11	500219.4
			500220.1	500220	20	3/4	85	74,5	16	96	50	36	16	500220.4
			500221.1	500221	25	1	87	75	18	99	50	46	18	500221.4
			500222.1	500222	30	1 1/4	107	93,5	20	120	70	50	25	500222.4
			500223.1	500223	38	1 1/2	109	93	22	123,5	70	60	29	500223.4

Note: If you wish to order AISI 316 stainless steel fittings, please change the first two digits from **50....** to **51....** .
If you wish to order AISI 316 stainless steel fittings with AISI 304 stainless steel nuts, please change the first two digits from **50....** to **54....** .

Series DIN	50.... [bar]	51.... [bar]	Ordering Body	Ordering Equipped B3	Ø Tube	M	L1	L2	L3	L4	CH1	CH2	Øpass.	Ordering Equipped B4
L	250	250	500304.1	500304	6	10x1	60	53	8	67,5	19	14	4	500304.4
			500305.1	500305	8	12x1,5	60	53	12	67,5	19	17	4	500305.4
			500306.1	500306	10	14x1,5	61	54	12	68,5	19	19	4	500306.4
			500307.1	500307	12	16x1,5	67	60	12	74,5	32	22	8	500307.4
			500308.1	500308	15	18x1,5	72	65	12	80	41	27	11	500308.4
	160	160	500309.1	500309	18	22x1,5	72	64,5	14	80,5	41	32	11	500309.4
			500310.1	500310	22	26x1,5	83	75,5	16	91,5	50	36	18	500310.4
			500311.1	500311	28	33x2	83	75,5	18	92	50	41	18	500311.4
			500312.1	500312	35	42x2	103	92,5	20	114	70	50	25	500312.4
			500313.1	500313	42	48x2	103	92	22	114,5	70	60	29	500313.4
S	400	400	500314.1	500314	6	12x1,5	62	55	12	69,5	19	17	4	500314.4
			500315.1	500315	8	14x1,5	62	55	12	69,5	19	19	4	500315.4
			500316.1	500316	10	16x1,5	68,5	61	12	77	32	22	7	500316.4
			500317.1	500317	12	18x1,5	68,5	61	12	77	32	24	8	500317.4
			500318.1	500318	14	20x1,5	74	66	14	83,5	41	27	10	500318.4
	250	250	500319.1	500319	16	22x1,5	74	65,5	14	83,5	41	30	11	500319.4
			500320.1	500320	20	27x2	85	74,5	16	96	50	36	16	500320.4
			500321.1	500321	25	33x2	87	75	18	99	50	46	18	500321.4
			500322.1	500322	30	42x2	107	93,5	20	120	70	50	25	500322.4
			500323.1	500323	38	48x2	109	93	22	123,5	70	60	29	500323.4

Note: If you wish to order AISI 316 stainless steel fittings, please change the first two digits from **50....** to **51....** .
If you wish to order AISI 316 stainless steel fittings with AISI 304 stainless steel nuts, please change the first two digits from **50....** to **54....** .

MALE STUD NON RETURN VALVE WITH ELASTOMER SEAL

Thread BSP Parallel - Thread Metric Parallel

Type: **5004...1** Body
Type: **5005...1** Body

Type: **5004.. B3** Ring
Type: **5005.. B3** Ring

Type: **5004...4** B4 Ring
Type: **5005...4** B4 Ring

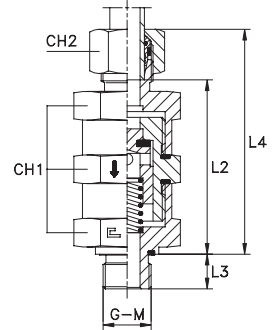
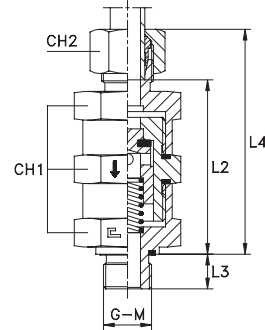
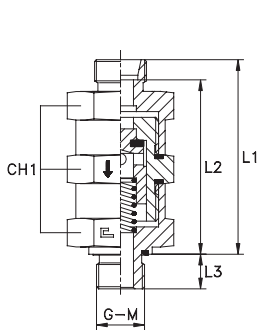

Series DIN	50.... [bar]	51.... [bar]	Ordering Body	Ordering Equipped B3	Ø Tube	G	L1	L2	L3	L4	CH1	CH2	Øpass.	Ordering Equipped B4
L	250	250	500404.1	500404	6	1/8	60	53	8	67,5	19	14	4	500404.4
			500405.1	500405	8	1/4	60	53	12	67,5	19	17	4	500405.4
			500406.1	500406	10	1/4	61	54	12	68,5	19	19	4	500406.4
			500407.1	500407	12	3/8	67,5	60,5	12	75	32	22	8	500407.4
			500408.1	500408	15	1/2	72	65	14	80	41	27	11	500408.4
	160	160	500409.1	500409	18	1/2	72	64,5	14	80,5	41	32	11	500409.4
			500410.1	500410	22	3/4	83	75,5	16	91,5	50	36	16	500410.4
			500411.1	500411	28	1	83	75,5	18	92	50	41	18	500411.4
			500412.1	500412	35	1 1/4	103	92,5	20	114	70	50	25	500412.4
			500413.1	500413	42	1 1/2	103	92	22	114,5	70	60	29	500413.4
S	400	400	500414.1	500414	6	1/4	62	55	12	69,5	19	17	4	500414.4
			500415.1	500415	8	1/4	62	55	12	69,5	19	19	4	500415.4
			500416.1	500416	10	3/8	68,5	61	12	77	32	22	7	500416.4
			500417.1	500417	12	3/8	68,5	61	12	77	32	24	8	500417.4
			500418.1	500418	14	1/2	74	66	14	83,5	41	27	10	500418.4
	250	250	500419.1	500419	16	1/2	74	65,5	14	83,5	41	30	11	500419.4
			500420.1	500420	20	3/4	85	74,5	16	96	50	36	16	500420.4
			500421.1	500421	25	1	87	75	18	99	50	46	18	500421.4
			500422.1	500422	30	1 1/4	107	93,5	20	120	70	50	25	500422.4
			500423.1	500423	38	1 1/2	109	93	22	123,5	70	60	29	500423.4

Note: If you wish to order AISI 316 stainless steel fittings, please change the first two digits from **50....** to **51....** .
If you wish to order AISI 316 stainless steel fittings with AISI 304 stainless steel nuts, please change the first two digits from **50....** to **54....** .

Series DIN	50.... [bar]	51.... [bar]	Ordering Body	Ordering Equipped B3	Ø Tube	M	L1	L2	L3	L4	CH1	CH2	Øpass.	Ordering Equipped B4
L	250	250	500504.1	500504	6	10x1	60	53	8	67,5	19	14	4	500504.4
			500505.1	500505	8	12x1,5	60	53	12	67,5	19	17	4	500505.4
			500506.1	500506	10	14x1,5	61	54	12	68,5	19	19	4	500506.4
			500507.1	500507	12	16x1,5	67	60,5	12	74,5	32	22	8	500507.4
			500508.1	500508	15	18x1,5	72	65	12	80	41	27	11	500508.4
	160	160	500509.1	500509	18	22x1,5	72	64,5	14	80,5	41	32	11	500509.4
			500510.1	500510	22	26x1,5	83	75,5	16	91,5	50	36	18	500510.4
			500511.1	500511	28	33x2	83	75,5	18	92	50	41	18	500511.4
			500512.1	500512	35	42x2	103	92,5	20	114	70	50	25	500512.4
			500513.1	500513	42	48x2	103	92	22	114,5	70	60	29	500513.4
S	400	400	500514.1	500514	6	12x1,5	62	55	12	69,5	19	17	4	500514.4
			500515.1	500515	8	14x1,5	62	55	12	69,5	19	19	4	500515.4
			500516.1	500516	10	16x1,5	68,5	61	12	77	32	22	7	500516.4
			500517.1	500517	12	18x1,5	68,5	61	12	77	32	24	8	500517.4
			500518.1	500518	14	20x1,5	74	66	14	83,5	41	27	10	500518.4
	250	250	500519.1	500519	16	22x1,5	74	65,5	14	83,5	41	30	11	500519.4
			500520.1	500520	20	27x2	85	74,5	16	96	50	36	16	500520.4
			500521.1	500521	25	33x2	87	75	18	99	50	46	18	500521.4
			500522.1	500522	30	42x2	107	93,5	20	120	70	50	25	500522.4
			500523.1	500523	38	48x2	109	93	22	123,5	70	60	29	500523.4

Note: If you wish to order AISI 316 stainless steel fittings, please change the first two digits from **50....** to **51....** .
If you wish to order AISI 316 stainless steel fittings with AISI 304 stainless steel nuts, please change the first two digits from **50....** to **54....** .

MALE STUD NON RETURN VALVE

Thread BSP Taper - Thread NPT

Type: **5006...1** Body
Type: **5007...1** Body

Type: **5006... B3** Ring
Type: **5007... B3** Ring

Type: **5006...4 B4** Ring
Type: **5007...4 B4** Ring

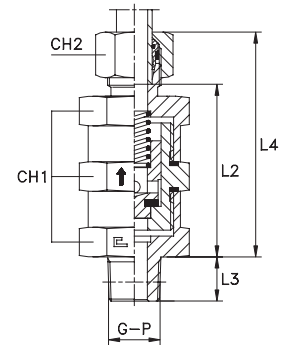
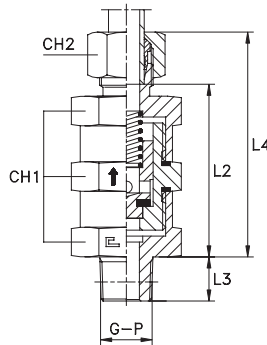
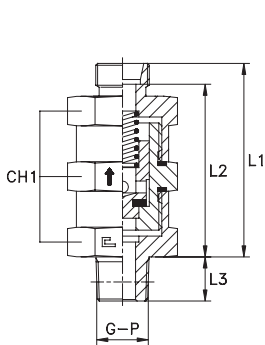

Series DIN	50.... [bar]	51.... [bar]	Ordering Body	Ordering Equipped B3	Ø Tube	G	L1	L2	L3	L4	CH1	CH2	Øpass.	Ordering Equipped B4
L	250	250	500604.1	500604	6	1/8	58	51	10	65,5	19	14	4	
			500605.1	500605	8	1/4	58	51	15	65,5	19	17	4	500605.4
			500606.1	500606	10	1/4	59	52	15	66,5	19	19	4	500606.4
			500607.1	500607	12	3/8	65	58	15	72,5	32	22	8	500607.4
			500608.1	500608	15	1/2	69	62	19	77	41	27	11	500608.4
	160	160	500609.1	500609	18	1/2	69	61,5	19	77,5	41	32	11	500609.4
			500610.1	500610	22	3/4	80	72,5	19	88,5	50	36	16	500610.4
			500611.1	500611	28	1	80	72,5	24	89	50	41	18	500611.4
			500612.1	500612	35	1 1/4	100	89,5	25	111	70	50	25	500612.4
			500613.1	500613	42	1 1/2	100	89	25	111,5	70	60	29	500613.4
S	400	400	500614.1	500614	6	1/4	60	53	15	67,5	19	17	4	500614.4
			500615.1	500615	8	1/4	60	53	15	67,5	19	19	4	500615.4
			500616.1	500616	10	3/8	66	58,5	15	74,5	32	22	7	500616.4
			500617.1	500617	12	3/8	66	58,5	15	74,5	32	24	8	500617.4
			500618.1	500618	14	1/2	71	63	19	80,5	41	27	10	500618.4
	250	250	500619.1	500619	16	1/2	71	62,5	19	80,5	41	30	11	500619.4
			500620.1	500620	20	3/4	82	71,5	19	93	50	36	16	500620.4
			500621.1	500621	25	1	84	72	24	96	50	46	18	500621.4
			500622.1	500622	30	1 1/4	104	90,5	25	117	70	50	25	500622.4
			500623.1	500623	38	1 1/2	106	90	25	120,5	70	60	29	500623.4

Note: If you wish to order AISI 316 stainless steel fittings, please change the first two digits from **50....** to **51....** .
If you wish to order AISI 316 stainless steel fittings with AISI 304 stainless steel nuts, please change the first two digits from **50....** to **54....** .
Items available on scheduled orders only

Series DIN	50.... [bar]	51.... [bar]	Ordering Body	Ordering Equipped B3	Ø Tube	P	L1	L2	L3	L4	CH1	CH2	Øpass.	Ordering Equipped B4
L	250	250	500704.1	500704	6	1/8	58	51	10	65,5	19	14	4	500704.4
			500705.1	500705	8	1/4	58	51	15	65,5	19	17	4	500705.4
			500706.1	500706	10	1/4	59	52	15	66,5	19	19	4	500706.4
			500707.1	500707	12	3/8	65	58	15	72,5	32	22	8	500707.4
			500708.1	500708	15	1/2	69	62	19	77	41	27	11	500708.4
	160	160	500709.1	500709	18	1/2	69	61,5	19	77,5	41	32	11	500709.4
			500710.1	500710	22	3/4	80	72,5	19	88,5	50	36	16	500710.4
			500711.1	500711	28	1	80	72,5	24	89	50	41	18	500711.4
			500712.1	500712	35	1 1/4	100	89,5	25	111	70	50	25	500712.4
			500713.1	500713	42	1 1/2	100	89	25	111,5	70	60	29	500713.4
S	400	400	500714.1	500714	6	1/4	60	53	15	67,5	19	17	4	500714.4
			500715.1	500715	8	1/4	60	53	15	67,5	19	19	4	500715.4
			500716.1	500716	10	3/8	66	58,5	15	74,5	32	22	7	500716.4
			500717.1	500717	12	3/8	66	58,5	15	74,5	32	24	8	500717.4
			500718.1	500718	14	1/2	71	63	19	80,5	41	27	10	500718.4
	250	250	500719.1	500719	16	1/2	71	62,5	19	80,5	41	30	11	500719.4
			500720.1	500720	20	3/4	82	71,5	19	93	50	36	16	500720.4
			500721.1	500721	25	1	84	72	24	96	50	46	18	500721.4
			500722.1	500722	30	1 1/4	104	90,5	25	117	70	50	25	500722.4
			500723.1	500723	38	1 1/2	106	90	25	120,5	70	60	29	500723.4

Note: If you wish to order AISI 316 stainless steel fittings, please change the first two digits from **50....** to **51....** .
If you wish to order AISI 316 stainless steel fittings with AISI 304 stainless steel nuts, please change the first two digits from **50....** to **54....** .
Items available on scheduled orders only

MALE STUD NON RETURN VALVE

Thread BSP Taper - Thread NPT

Type: **5008...1** Body
Type: **5009...1** Body

Type: **5008.. B3** Ring
Type: **5009.. B3** Ring

Type: **5008...4** B4 Ring
Type: **5009...4** B4 Ring

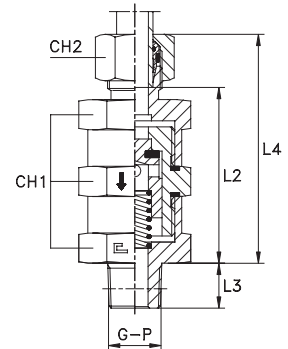
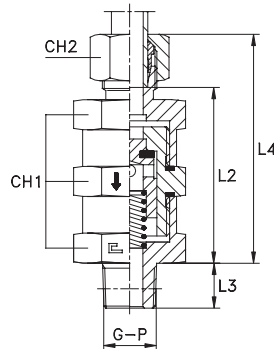
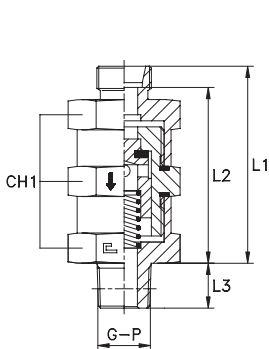

Series DIN	50.... [bar]	51.... [bar]	Ordering Body	Ordering Equipped B3	Ø Tube	G	L1	L2	L3	L4	CH1	CH2	Øpass.	Ordering Equipped B4
L	250	250	500804.1	500804	6	1/8	58	51	10	65,5	19	14	4	500805.4
			500805.1	500805	8	1/4	58	51	15	65,5	19	17	4	500805.4
			500806.1	500806	10	1/4	59	52	15	66,5	19	19	4	500806.4
			500807.1	500807	12	3/8	65	58	15	72,5	32	22	8	500807.4
			500808.1	500808	15	1/2	69	62	19	77	41	27	11	500808.4
	160	160	500809.1	500809	18	1/2	69	61,5	19	77,5	41	32	11	500809.4
			500810.1	500810	22	3/4	80	72,5	19	88,5	50	36	16	500810.4
			500811.1	500811	28	1	80	72,5	24	89	50	41	18	500811.4
	100	100	500812.1	500812	35	1 1/4	100	89,5	25	111	70	50	25	500812.4
			500813.1	500813	42	1 1/2	100	89	25	111,5	70	60	29	500813.4
			500814.1	500814	6	1/4	60	53	15	67,5	19	17	4	500814.4
			500815.1	500815	8	1/4	60	53	15	67,5	19	19	4	500815.4
S	400	400	500816.1	500816	10	3/8	66	58,5	15	74,5	32	22	7	500816.4
			500817.1	500817	12	3/8	66	58,5	15	74,5	32	24	8	500817.4
			500818.1	500818	14	1/2	71	63	19	80,5	41	27	10	500818.4
			500819.1	500819	16	1/2	71	62,5	19	80,5	41	30	11	500819.4
			500820.1	500820	20	3/4	82	71,5	19	93	50	36	16	500820.4
			500821.1	500821	25	1	84	72	24	96	50	46	18	500821.4
	250	250	500822.1	500822	30	1 1/4	104	90,5	25	117	70	50	25	500822.4
			500823.1	500823	38	1 1/2	106	90	25	120,5	70	60	29	500823.4

Note: If you wish to order AISI 316 stainless steel fittings, please change the first two digits from **50....** to **51....** .
If you wish to order AISI 316 stainless steel fittings with AISI 304 stainless steel nuts, please change the first two digits from **50....** to **54....** .
Items available on scheduled orders only

Series DIN	50.... [bar]	51.... [bar]	Ordering Body	Ordering Equipped B3	Ø Tube	P	L1	L2	L3	L4	CH1	CH2	Øpass.	Ordering Equipped B4
L	250	250	500904.1	500904	6	1/8	58	51	10	65,5	19	14	4	500904.4
			500905.1	500905	8	1/4	58	51	15	65,5	19	17	4	500905.4
			500906.1	500906	10	1/4	59	52	15	66,5	19	19	4	500906.4
			500907.1	500907	12	3/8	65	58	15	72,5	32	22	8	500907.4
			500908.1	500908	15	1/2	69	62	19	77	41	27	11	500908.4
	160	160	500909.1	500909	18	1/2	69	61,5	19	77,5	41	32	11	500909.4
			500910.1	500910	22	3/4	80	72,5	19	88,5	50	36	16	500910.4
			500911.1	500911	28	1	80	72,5	24	89	50	41	18	500911.4
	100	100	500912.1	500912	35	1 1/4	100	89,5	25	111	70	50	25	500912.4
			500913.1	500913	42	1 1/2	100	89	25	111,5	70	60	29	500913.4
			500914.1	500914	6	1/4	60	53	15	67,5	19	17	4	500914.4
			500915.1	500915	8	1/4	60	53	15	67,5	19	19	4	500915.4
S	400	400	500916.1	500916	10	3/8	66	58,5	15	74,5	32	22	7	500916.4
			500917.1	500917	12	3/8	66	58,5	15	74,5	32	24	8	500917.4
			500918.1	500918	14	1/2	71	63	19	80,5	41	27	10	500918.4
			500919.1	500919	16	1/2	71	62,5	19	80,5	41	30	11	500919.4
			500920.1	500920	20	3/4	82	71,5	19	93	50	36	16	500920.4
			500921.1	500921	25	1	84	72	24	96	50	46	18	500921.4
250	250	500922.1	500922	30	1 1/4	104	90,5	25	117	70	50	25	500922.4	
		500923.1	500923	38	1 1/2	106	90	25	120,5	70	60	29	500923.4	

Note: If you wish to order AISI 316 stainless steel fittings, please change the first two digits from **50....** to **51....** .
If you wish to order AISI 316 stainless steel fittings with AISI 304 stainless steel nuts, please change the first two digits from **50....** to **54....** .
Items available on scheduled orders only

PLANT N.° 1-2 VOLPIANO (TO)

Warehouse and sale offices of CAST S.p.A.





SAE-J514

















JIC

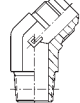
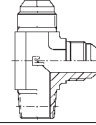
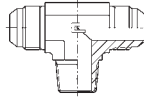
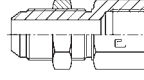
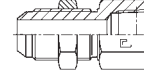
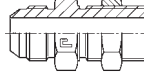
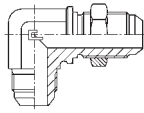
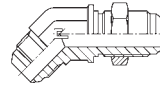
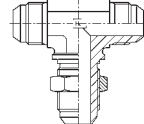
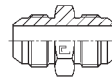
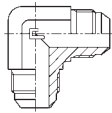
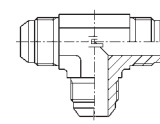
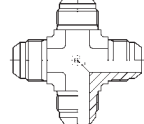
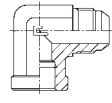
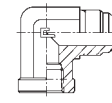
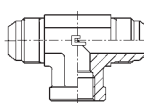
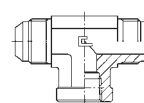
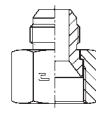
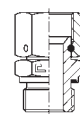
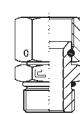
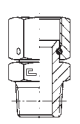
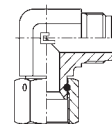
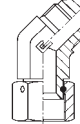
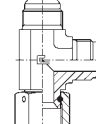
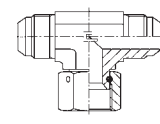
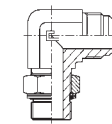
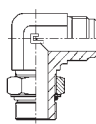
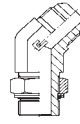
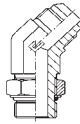
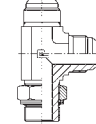
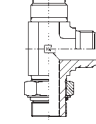
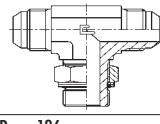
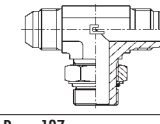
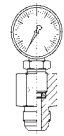
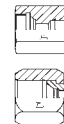

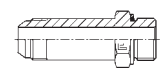
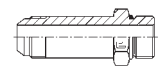
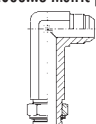
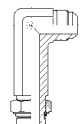
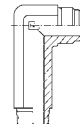

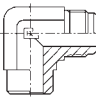
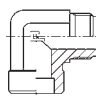
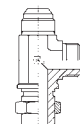
AVAILABLE IN CARBON AND STAINLESS STEEL

20

FIGURATIVE INDEX – FITTINGS SAE J514 - ISO 8434-2

General instructions Utilisation standards	Quality assurance Safety factors	Allowed temperatures Seals on threads	Finish treatments End treatments	Tubes to be used Tables follow up	Threaded ends Gas - Metric UNF - NPT	Prescriptions to comply with Assembly instructions
Page 105 Type: 2001.. 	Page 22 Type: 2002.. 	Page 23 Type: 2003...3 BSPP Type: 2004...3 Metric paral. 	Page 24 Type: 2005...3 UNF/UN-2A 	Page 25-26 Type: 2006...3 BSPP 	Page 27-32 Type: 2007...3 NPTF 	Page 33;39; 106-107 Type: 2008...3 BSPT Type: 2009...3 NPTF 
Page 108 Type: 2010...3 BSPT Type: 2011...3 NPTF 	Page 108 Type: 2012...3 BSPT Type: 2013...3 NPTF 	Page 109 Type: 2014...3 BSPT Type: 2015...3 NPTF 	Page 110 Type: 2016...3 BSPT Type: 2017...3 NPTF 	Page 111 Type: 2018...3 BSPP 	Page 111 Type: 2019...3 NPTF 	Page 112 Type: 2020...3 
Page 113 Type: 2021...3 	Page 114 Type: 2022...3 	Page 115 Type: 2023...3 	Page 116 Type: 2024...3 	Page 117 Type: 2025...3 	Page 117 Type: 2026...3 	Page 118 Type: 2027...3 
Page 118 Type: 2028...3 BSPP 	Page 119 Type: 2029...3 NPTF 	Page 119 Type: 2032...3 BSPP 	Page 120 Type: 2033...3 NPTF 	Page 120 Type: 2034...3 	Page 121 Type: 2035.. BSPP Type: 2036.. Metric paral. 	Page 121 Type: 2037.. UNF/UN-2A 
Page 122 Type: 2038.. BSPT Type: 2039.. NPTF 	Page 122 Type: 2040...3 	Page 123 Type: 2041...3 	Page 123 Type: 2042...3 	Page 124 Type: 2043...3 	Page 125 Type: 2044...3 BSPP Type: 2045...3 Metric paral. 	Page 126 Type: 2046...3 UNF/UN-2A 
Page 127 Type: 2047...3 BSPP Type: 2048...3 Metric paral. 	Page 128 Type: 2049...3 UNF/UN-2A 	Page 128 Type: 2050...3 BSPP Type: 2051...3 Metric paral. 	Page 129 Type: 2052...3 UNF/UN-2A 	Page 129 Type: 2053...3 BSPP Type: 2054...3 Metric paral. 	Page 130 Type: 2055...3 UNF/UN-2A 	Page 131 Type: 2056...3 BSPP 
Page 132 Type: 2057.. UNF/UN-2A 	Page 133 Type: 2058...3 BSPP Type: 2059...3 Metric paral. 	Page 134 Type: 2060.. BSPP Type: 2061.. Metric paral. 	Page 135 Type: 2062...3 BSPP Type: 2063...3 Metric paral. 	Page 136 Type: 2064...3 UNF/UN-2A 	Page 137 Type: 2065...3 BSPP Type: 2066...3 Metric paral. 	Page 138 Type: 2067...3 UNF/UN-2A 
Page 138 Type: 2068...3 NPTF 	Page 139 Type: 2069...3 	Page 140 Type: 2070...3 	Page 141 Type: 2071...3 	Page 142 Type: 2072...3 	Page 143-144 Type: 2073.. 	Page 145 Type: 2074...3 
Page 145	Page 146	Page 146	Page 147	Page 147	Page 148	Page 148

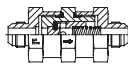
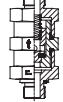
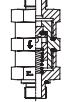
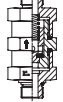
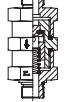
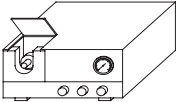
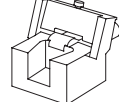
FIGURATIVE INDEX – FITTINGS SAE J514 - ISO 8434-2

Type: 2075.. UNF/UN-2A 	Type: 2076.. 	Type: 5014...3 	Type: 5015...3 BSPP Type: 5016...3 Metric paral. 	Type: 5017...3 BSPP Type: 5018...3 Metric paral. 	Type: 5019...3 UNF/UN-2A 	Type: 5020...3 UNF/UN-2A 
Page 148	Page 148	Page 149	Page 149	Page 150	Page 150	Page 150
Type: 100000 	Type: 200000 	Type: 2000.. 	Type: 2000.. 	Compatible fluids table		
Page 101	Page 101	Page 101	Page 101		Page 325-356	Page

ATTREZZATURE SERIE SAE J514 - ISO 8434-2

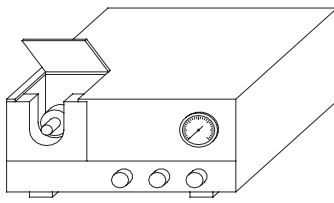
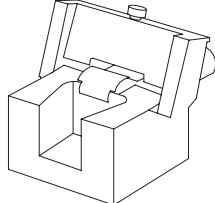
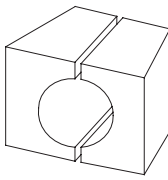
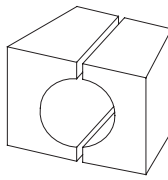
TUBE FLARING MACHINE		37° FLARING BLOCK	METRIC		INCHES	
						
Series	Ordering Machine	Ordering 37° flaring block	Ø Tube	Ordering metric	Ø Tube	Ordering inches
UNIVERSAL	100000	200000	6	200001	1/4	200021
			8	200002	5/16	200022
			10	200003	3/8	200023
			12	200004	1/2	200024
			16	200005	5/8	200025
			20	200006	3/4	200026
			25	200007	1	200027
			32	200008	1.1/4	200028
			38	200009	1.1/2	200029
			14	200010		
			15	200011		
			18	200012		
			30	200013		

ORDERING EXAMPLES (Carbon steel)

ORDERING EXAMPLES (Stainless steel)

SAE

- If you require a male stud coupling for a Ø 20 mm tube with 3/4" BSP parallel thread made of carbon steel with elastomeric NBR seal on the thread, order 200306.3

- If you require the VITON® seal, add "V" at the end.

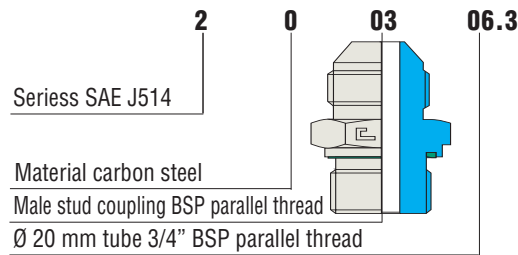

SAE

- If you require a male stud coupling for a Ø 20 mm tube with 3/4" BSP parallel thread made of stainless steel with elastomeric VITON® seal on the thread, order 210306.3

- If you require the NBR seal, add ".N" at the end.

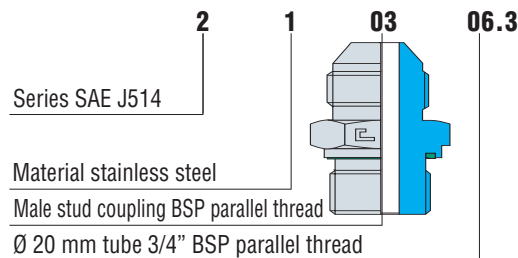

SAE

- If you wish to use a carbon steel tube with inch measurements, add the letter ".W" to the code of the pressure sleeve to order: 200106.W

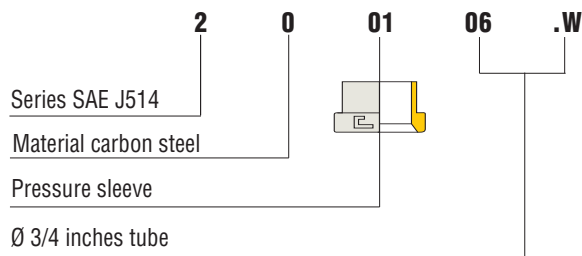

SAE

- If you wish to use a stainless steel tube with inch measurements, add the letter ".W" to the code of the pressure sleeve to order: 210106.W

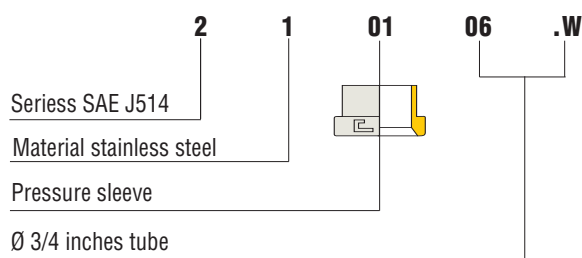

DELIVERIES

- Cast S.p.A. fittings are delivered in the configurations shown in the tables of this catalogue.
- Available on scheduled orders only: it means that the article is slow moving and will be delivered within 90 days.
- Available on request only: it means that the article is not commonly in stock; please contact our offices for further delivery details.

VITON® is a DuPont Dow Elastomers Trade Mark

THEORY OF OPERATION

The CAST fitting, manufactured according to ISO 8434-2/SAE J514, is a mechanical fitting traditionally used for high pressure fluid-dynamic systems. The seal is made by the contact between two conical surfaces, the first created on the fitting body and the second obtained on the cold drawn seamless tube, through flaring obtained with special tools.

The coupling between the body of the fitting and the 37° flared tube is guaranteed by the tightening nut and by the pressure sleeve on the inside. It helps fast assembly of removable tubes, avoids welding and tapping, thus assuring maximum simplicity for complex oleo-dynamic systems. Repeated assemblies do not alter the performance of the coupling.

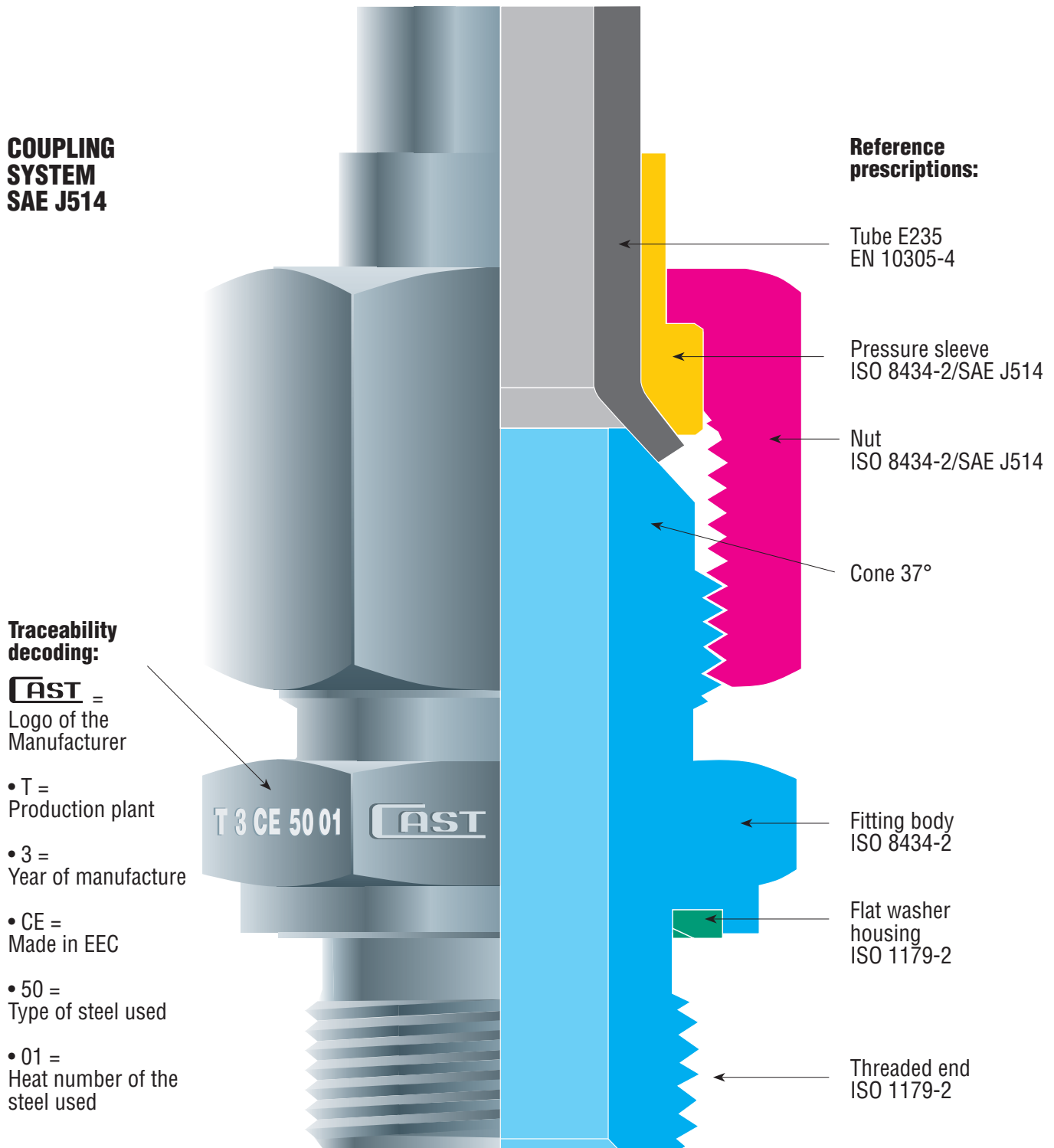

TECHNICAL CHARACTERISTICS

CAST 37° fittings assure perfect seal regardless of the fluid used, provided that no corrosive fluids are employed, the nominal pressures of the fittings and the indicated temperatures are respected and the prescriptions of the manufacturer are followed scrupulously.

These fittings are manufactured in a single series defined “UNIVERSAL” since the fitting body and the tightening nut remain the same also when switching from a metric tube at an inches sized tube. There are no doubles of diameters with different working pressures.

Normal vibrations do not alter the functionality of this type of fitting, also at the top quoted values. Therefore the fitting maintains its best characteristics of absolute guarantee, safety and reliability. For these specific reasons this fitting may be used in hard working conditions and where high safety parameters apply to the system.

Under the mechanical strength given by the tightening of the nut on the fitting body, the part of the 37° flared tube couples with the 37° conical part of the fitting body to provide a very effective, repeated, safe and easy to make metal to metal seal.

The pressure sleeve housed inside the tightening nut ensures the self-alignment of the flared tube to the axis of the fitting body, supports the tube during operation, lowers the vibrations and avoids damage to the tube while tightening.

Before assembly on the metal tube

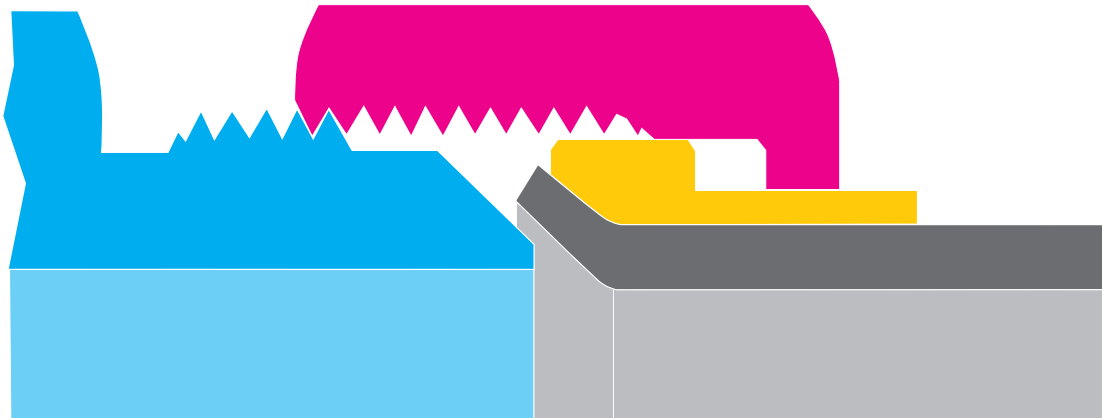

After assembly on the metal tube

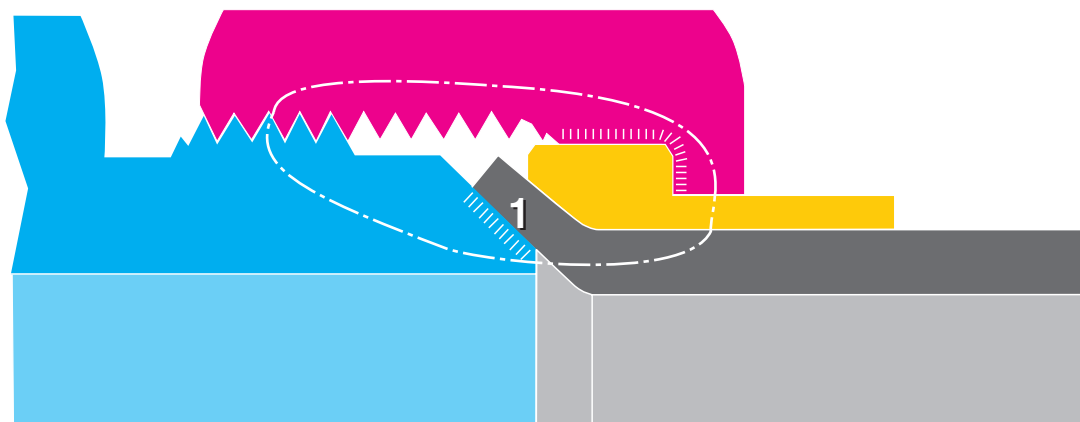

Field of force

Pressure surfaces
|||||

Sealing points
1

PRODUCT MATURITY

For many years now there has been an increasing imperative market demand for fluid system components that guarantee three main factors: SAFE ANCHORING, FUNCTIONAL ASSEMBLY, LEAKAGE-FREE TIGHTNESS. These elements, now considered essential for a safe working environment (Leg. Decree 81/2008), product liability (Presidential Decree 224-EEC 85/374) and for the entire environmental protection system, make the 37° fitting manufactured by CAST S.p.A. a reliable and consolidated product.

GENERAL INSTRUCTIONS

- Before starting to flare the tubes, please check that all the tools to be used in the process conform to the standards. Carefully check the tools every 30-50 flarings.
- Before connecting the preassembled tube to the equipment it is necessary to check that the tube and the fitting are aligned. Fittings should never be used to correct a wrong alignment or to be a support for the tube. Extremely long tubes or tubes undergoing high stress must be fixed by using some support to avoid excessive vibrations. A poor alignment could damage the operation of the system.
- The proper lubrication of the components involved in the tightening is essential for good system operation. We advise the use of mineral oils or torquen tension for carbon steel fittings, consisting of anti-seizing compound (Nickel based), Chesterton or similar, for stainless steel fittings.
- The fittings and the valves in this technical catalogue may be used for fluid-dynamic connections only. Indicated pressures are for steel tubes only.
- Mixing carbon and stainless steel components is not allowed.

UTILISATION STANDARDS

CARBON STEEL FITTINGS

- High quality tubes must be employed to assure correct use and related technical performance of the carbon steel fitting. The use of tubes without the aforementioned characteristics may seriously impair the efficiency of the fitting. CAST S.p.A. recommends using the following tubes only: calibrated and polished, cold drawn seamless tubes, normalised with inert gas, in E235 material according to EN 10305-4 (ST 37.4 according to DIN 1630 I DIN 2391). The maximum hardness allowed on the outside diameter of the tube is 75 HRB.
- The flaring of the tube must be made with the flaring machine model 200000 and not with simple punches, which are hard to use and make the correct axiality of the 37° flaring complicated to obtain. It is important that the flaring is concentric and perpendicular to the tube and ferrule.
- In order to obtain a curve of the tube as close to the tightening point as possible (fitting body), the structural constructing ties that are typical of the 37° universal fittings must be considered. This product forces the user to leave a part of the ending section of the tube perfectly straight. This part must be used during the flaring operation to block the tube. Please refer to the "C" quote in the table for the measurements.

STAINLESS STEEL FITTINGS

High quality tubes must be employed to assure correct use and related technical performance of stainless steel fittings. The use of tubes without the aforementioned characteristics may seriously impair the efficiency of the fitting. CAST S.p.A. recommends using the following tubes only: calibrated and polished, cold drawn seamless tubes 1.4571 as per UNI EN 10216-5 or ASTM A 269; the maximum permitted hardness, measured on the outer diameter of the tube, is 85 HRB.

- The flaring of the tube must be made with the flaring machine model 200000 and not with simple punches, which are hard to use and make the correct axiality of the 37° flaring complicated to obtain. It is important that the flaring is concentric and perpendicular to the tube and ferrule.
- In order to obtain a curve of the tube as close to the tightening point as possible (fitting body), the structural constructing ties that are typical of the 37° universal fittings must be considered. This product forces the user to leave a part of the ending section of the tube perfectly straight. This part must be used during the flaring operation to block the tube. Please refer to the "C" quote in the table for the measurements.

TECHNICAL DATA FOR THE FLARING OF 37° TUBES

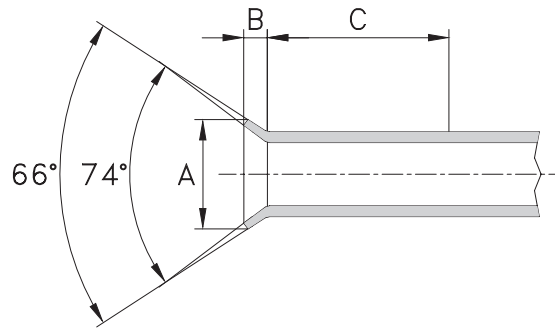

Ø Metric tube	Ø Inch tube	Ø Flaring		B	Blocking C
		A min	A max		
6x1	1/4x0.89	8.6	9.1	2.5	32
6x1.5	1/4x1.65	8.9	9.1	2.7	
8x1	5/16x0.89	10.2	10.9	2.3	35
8x1.5	5/16x1.65	10.2	10.9	2.5	
10x1	3/8x0.89	11.7	12.4	2	40
10x1.5	3/8x1.65	11.7	12.4	2.2	
12x1	1/2x0.89	16	16.8	3.7	45
12x1.5	1/2x1.65	16	16.8	3.9	
12x2	1/2x2.1	16	16.8	4.1	45
14x1.5	-	19.3	20.1	4.8	
14x2	-	19.3	20.1	5.1	45
15x1.5	-	19.3	20.1	4.1	
15x2	-	19.3	20.1	4.3	45
16x1.5	5/8x1.65	19.3	20.1	3.4	
16x2	5/8x2.1	19.3	20.1	3.6	45
16x2.5	5/8x2.41	19.3	20.1	3.8	
18x2	-	23.4	24.1	5.1	50
18x2.5	-	23.4	24.1	5.3	
20x2	3/4x2.1	23.4	24.1	3.6	50
20x2.5	3/4x2.41	23.4	24.1	3.8	
20x3	3/4x3.05	23.4	24.1	4.1	60
25x2	1x2.1	29.7	30.5	4.6	
25x3	1x3.05	29.7	30.5	5.1	60
30x2	-	37.6	38.4	6.7	
30x3	-	37.6	38.4	7.2	60
32x2	1 1/4x2.1	37.6	38.4	5.3	
32x3	1 1/4x3.05	37.6	38.4	5.7	60
38x3	1 1/2x3.05	43.2	43.9	5.4	
38x4	1 1/2x4.05	*	*	5.8	70

* For further information on the flaring diameter please contact CAST S.p.A. directly

TIGHTENING TORQUES TUBE SIDE AND ON THE CONE (For carbon and stainless steel)

Series	Ø Metric tube	Ø Inch tube	Thread UNF/UN-2A	Tube side torque (Nm) ^{+10%} ₀	Torque swivel cone (Nm) ^{+10%} ₀
UNIVERSAL	6	1/4	7/16-20 UNF-2A	10	20
	8	5/16	1/2-20 UNF-2A	20	25
	10	3/8	9/16-18 UNF-2A	25	35
	12	1/2	3/4-16 UNF-2A	45	60
	14-15-16	5/8	7/8-14 UNF-2A	75	85
	18-20	3/4	1 1/16-12 UN-2A	115	140
	25	1	1 5/16-12 UN-2A	160	230
	30-32	1 1/4	1 5/8-12 UN-2A	240	380
	38	1 1/2	1 7/8-12 UN-2A	400	460

Notes:

The values in the tightening tables are approximate and derive from practical tests run at the laboratory in Casalgrasso (CN), which may vary based on the materials and tolerances of the components used. Thus an awareness of the controls to be performed is required.

All the values expressed in Newton Meters (Nm) for the tightening torques tube side on the SAE J514 cone represent the torquing moment, calculated on the maximum thickness of the usable tube, needed to obtain the correct tightness.

All the values expressed in Newton Meters (Nm) for the tightening torques on the SAE J514 swivel cone represent the torquing moment needed to obtain the correct tightness.

ASSEMBLY INSTRUCTIONS SAE J514

1. Before starting the 37° tube flaring and assembly operations, please check that all the tools to be used are in perfect working order. Substitute those not complying to the requirements.
2. Cut the tube square by using an appropriate hack-saw (do not use roller type tube cutters). Check that the cut is properly made at 90°. Remove any internal and external burrs.
3. Check for any leakage line and other structural defects that may impair the seal on the cone of the fitting body. Reject any non complying tube.
4. Thoroughly clean the part of the tube to be flared and lubricate it with appropriate products.
5. Assemble the nut and pressure sleeve on the tube as shown below, taking care that the open part of the nut faces the end of the tube to be flared; likewise, the end of the tube to be flared must face the greater diameter of the pressure sleeve.
6. To obtain the desired length of the tube please add the B quote to the desired length of the tube available in the technical data for tube flaring. This lengthening will be entirely absorbed during the assembly phase by the overlap created by the flared tube on the cone of the fitting.
7. Flare the tube using the appropriate flaring machine, carefully respecting all the indications reported in the table to the side. The drawing indicates the quotes that must be considered.
8. Check that the flaring of the tube has been done correctly and that no peeling of the material appears inside it.
9. Clean the nut, fitting and tube and lubricate with the suggested products.
10. Couple the flared tube on the cone of the fitting and tighten by hand the nut on the body of the fitting to check the correct alignment of the parts; using a wrench, tighten until reaching the contact of the metal to metal conical parts.
11. Repeated assembly and disassembly will not alter the functionality of the system which, each time is closed, will always provide an immediate seal, which will last over time.
12. Please refer to the table on page 106 for the correct tightening torques to be applied.

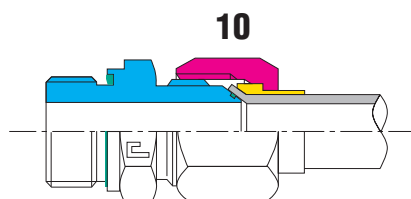
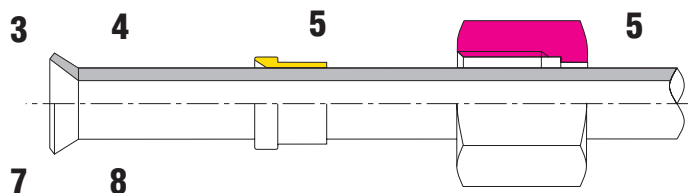
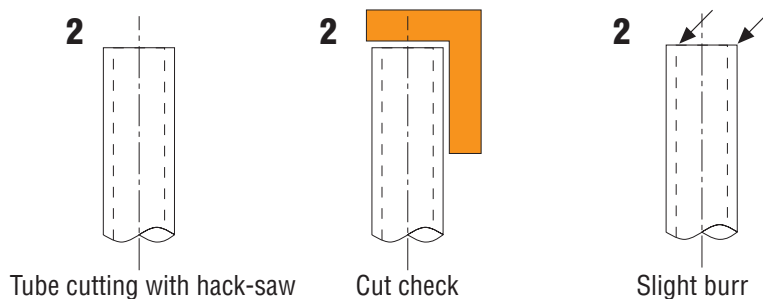

SLEEVE

Type: 2001..

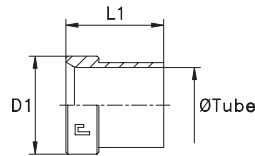

Serie JIC	20.... [bar]	21.... [bar]	Ordering Complete	Ø Tube M	Ø Tube W	D1	L1
UNIVERSAL	450	450	200101	6	-	9,7	10,4
			200102	8	5/16*	11,3	11,2
	350	350	200103	10	-	12,7	12,7
			200104	12	-	17,3	14,2
			200105	16	5/8*	20,2	16,8
			200106	20	-	24,6	17,3
	290	290	200107	25	-	31	19,8
	240	240	200108	32	-	38,9	23,1
			200109	38	1 1/2*	45,3	28,4
	350	350	200110	14	-	20,2	16,8
			200111	15	-	20,2	16,8
			200112	18	-	24,6	17,3
	240	240	200113	30	-	38,9	23,1
	450	450	200101.W	-	1/4	9,7	10,4
	350	350	200103.W	-	3/8	12,7	12,7
			200104.W	-	1/2	17,3	14,2
200106.W			-	3/4	24,6	17,3	
200107.W			-	1	31	19,8	
240	240	200108.W	-	1 1/4	38,9	23,1	

Notes: If you wish to order a fitting in stainless steel, please change the first two digit from 20.... to 21.....

* Order with metric tube diameter code.

TIGHTNING NUT

Type: 2002..

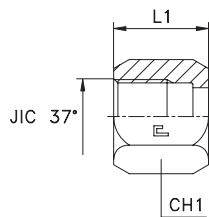

Series JIC	20.... [bar]	21.... [bar]	Ordering Complete	Ø Tube M	Ø Tube W	JIC 37°	L1	CH1
UNIVERSAL	450	450	200201	6	1/4*	7/16-20	15,5	14
			200202	8	5/16*	1/2-20	17	17
	350	350	200203	10	3/8*	9/16-18	18,3	19
			200204	12	1/2*	3/4-16	21,3	22
			200205	14-15-16	5/8*	7/8-14	24,6	27
			200206	18-20	3/4*	1 1/16-12	25,9	32
	290	290	200207	25	1*	1 5/16-12	28,5	41
	240	240	200208	30-32	1 1/4*	1 5/8-12	31	50
			200209	38	1 1/2*	1 7/8-12	35,8	60

Notes: If you wish to order AISI 316 stainless steel fittings, please change the first two digits from 20.... to 21.....

If you wish to order AISI 304 stainless steel fittings, please change the first two digits from 20.... to 44.....

* Order with metric tube diameter code.

MALE STUD COUPLING WITH ELASTOMER SEAL

Thread BSP Parallel - Thread Metric Parallel

Type: 2003...3
Type: 2004...3

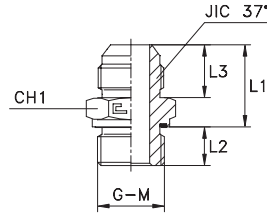

Series JIC	20.... [bar]	21.... [bar]	Ordering Complete	Ø Tube M	Ø Tube W	G	L1	L2	L3	CH1	JIC 37°
UNIVERSAL	350	350	200301.3	6	1/4	1/8	22,5	8	13,9	14	7/16-20
			200302.3	8	5/16	1/8	22,5	8	13,9	14	1/2-20
			200303.3	10	3/8	1/4	22,5	12	14	19	9/16-18
			200304.3	12	1/2	3/8	26,5	12	16,7	22	3/4-16
			200305.3	14-15-16	5/8	1/2	31	14	19,3	27	7/8-14
	200306.3	18-20	3/4	3/4	35	16	21,9	32	1 1/16-12		
	290	290	200307.3	25	1	1	37,5	18	23,1	41	1 5/16-12
	240	240	200308.3	30-32	1 1/4	1 1/4	41	20	24,3	50	1 5/8-12
			200309.3	38	1 1/2	1 1/2	45	22	27,5	55	1 7/8-12
	350	350	200310.3	6	1/4	1/4	22,5	12	13,9	19	7/16-20
			200311.3	6	1/4	3/8	24	12	13,9	22	7/16-20
			200312.3	6	1/4	1/2	25,5	14	13,9	27	7/16-20
			200313.3	8	5/16	1/4	22,5	12	13,9	19	1/2-20
			200314.3	8	5/16	3/8	24	12	13,9	22	1/2-20
			200315.3	10	3/8	1/8	22,5	8	14	17	9/16-18
			200316.3	10	3/8	3/8	24	12	14	22	9/16-18
			200317.3	10	3/8	1/2	26	14	14	27	9/16-18
			200318.3	12	1/2	1/4	26	12	16,7	22	3/4-16
			200319.3	12	1/2	1/2	28,5	14	16,7	27	3/4-16
			200320.3	12	1/2	3/4	30	16	16,7	32	3/4-16
			200321.3	14-15-16	5/8	3/8	30,5	12	19,3	24	7/8-14
			200322.3	14-15-16	5/8	3/4	32,5	16	19,3	32	7/8-14
			200323.3	18-20	3/4	3/8	34,5	12	21,9	30	1 1/16-12
			200324.3	18-20	3/4	1/2	35	14	21,9	30	1 1/16-12
	290	290	200325.3	18-20	3/4	1	36,5	18	21,9	41	1 1/16-12
			200326.3	25	1	3/4	37,5	16	23,1	36	1 5/16-12
	240	240	200327.3	25	1	1 1/4	40	20	23,1	50	1 5/16-12
			200328.3	30-32	1 1/4	1	41	18	24,3	46	1 5/8-12
			200329.3	30-32	1 1/4	1 1/2	42	22	24,3	55	1 5/8-12
			200330.3	38	1 1/2	1 1/4	44	20	27,5	50	1 7/8-12

Notes: If you wish to order a fitting in stainless steel, please change the first two digit from 20.... to 21....

Series JIC	20.... [bar]	21.... [bar]	Ordering Complete	Ø Tube M	Ø Tube W	M	L1	L2	L3	CH1	JIC 37°
UNIVERSAL	350	350	200401.3	6	1/4	10x1	21	8	13,9	14	7/16-20
			200402.3	8	5/16	12x1,5	21	12	13,9	17	1/2-20
			200403.3	10	3/8	14x1,5	21	12	14	19	9/16-18
			200404.3	12	1/2	16x1,5	21	12	16,7	22	3/4-16
			200405.3	14-15-16	5/8	22x1,5	29,5	14	19,3	27	7/8-14
	200406.3	18-20	3/4	27x2	32,5	16	21,9	32	1 1/16-12		
	290	290	200407.3	25	1	33x2	34,5	18	23,1	41	1 5/16-12
	240	240	200408.3	30-32	1 1/4	42x2	38	20	24,3	50	1 5/8-12
			200409.3	38	1 1/2	48x2	41,5	22	27,5	55	1 7/8-12
	350	350	200410.3	6	1/4	12x1,5	21	12	13,9	17	7/16-20
			200411.3	8	5/16	10x1	21	8	13,9	14	1/2-20
			200412.3	8	5/16	14x1,5	21	12	13,9	19	1/2-20
			200413.3	10	3/8	16x1,5	21,5	12	14	22	9/16-18
			200414.3	12	1/2	14x1,5	24	12	16,7	19	3/4-16
			200415.3	12	1/2	18x1,5	25,5	12	16,7	24	3/4-16
			200416.3	14-15-16	5/8	18x1,5	28	12	19,3	24	7/8-14
	200417.3	14-15-16	5/8	20x1,5	29	14	19,3	27	7/8-14		
	200418.3	18-20	3/4	22x1,5	32,5	14	21,9	30	1 1/16-12		
	290	290	200419.3	25	1	27x2	34,5	16	23,1	36	1 5/16-12

Notes: If you wish to order a fitting in stainless steel, please change the first two digit from 20.... to 21....
Articles available on scheduled orders only.

MALE STUD COUPLING WITH O-RING

Thread UNF/UN-2A

Type: 2005...3

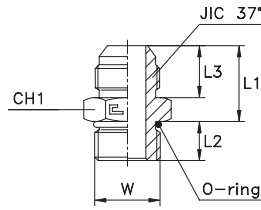

Series JIC	20.... [bar]	21.... [bar]	Ordering Complete	Ø Tube M	Ø Tube W	W	L1	L2	L3	CH1	JIC 37°
UNIVERSAL	400	400	200501.3	6	1/4	7/16-20	21,9	9,1	13,9	14	7/16-20
			200502.3	8	5/16	1/2-20	21,9	9,1	13,9	17	1/2-20
	350	350	200503.3	10	3/8	9/16-18	23	10	14	17	9/16-18
			200504.3	12	1/2	3/4-16	26,4	11,1	16,7	22	3/4-16
			200505.3	14-15-16	5/8	7/8-14	30,3	12,7	19,3	27	7/8-14
			200506.3	18-20	3/4	1 1/16-12	34,9	15,1	21,9	32	1 1/16-12
	290	290	200507.3	25	1	1 5/16-12	36,4	15,1	23,1	41	1 5/16-12
	240	240	200508.3	30-32	1 1/4	1 5/8-12	39,9	15,1	24,3	50	1 5/8-12
			200509.3	38	1 1/2	1 7/8-12	44,9	15,1	27,5	55	1 7/8-12
	400	400	200510.3	6	1/4	1/2-20	21,9	9,1	13,9	17	7/16-20
	350	350	200511.3	6	1/4	9/16-18	23	10	13,9	17	7/16-20
			200512.3	6	1/4	3/4-16	23,9	11,1	13,9	22	7/16-20
			200513.3	8	5/16	9/16-18	23	10	13,9	17	1/2-20
			200514.3	10	3/8	7/16-20	22,9	9,1	14	17	9/16-18
			200515.3	10	3/8	1/2-20	23,9	9,1	14	17	9/16-18
			200516.3	10	3/8	3/4-16	23,9	11,1	14	22	9/16-18
			200517.3	10	3/8	7/8-14	25,3	12,7	14	27	9/16-18
			200518.3	12	1/2	9/16-18	26,5	10	16,7	22	3/4-16
			200519.3	12	1/2	7/8-14	27,8	12,7	16,7	27	3/4-16
			200520.3	12	1/2	1 1/16-12	29,9	15,1	16,7	32	3/4-16
			200521.3	14-15-16	5/8	3/4-16	30,4	11,1	19,3	24	7/8-14
			200522.3	14-15-16	5/8	1 1/16-12	32,4	15,1	19,3	32	7/8-14
			200523.3	18-20	3/4	3/4-16	33,9	11,1	21,9	30	1 1/16-12
			200524.3	18-20	3/4	7/8-14	33,8	12,7	21,9	30	1 1/16-12
	290	290	200525.3	18-20	3/4	1 5/16-12	35,4	15,1	21,9	41	1 1/16-12
			200526.3	25	1	7/8-14	36,3	12,7	23,1	36	1 5/16-12
			200527.3	25	1	1 1/16-12	36,4	15,1	23,1	36	1 5/16-12
	240	240	200528.3	25	1	1 5/8-12	38,9	15,1	23,1	50	1 5/16-12
			200529.3	30-32	1 1/4	1 5/8-12	38,9	15,1	24,3	46	1 5/8-12
			200530.3	38	1 1/2	1 5/8-12	42,9	15,1	27,5	50	1 7/8-12

Notes: If you wish to order a fitting in stainless steel, please change the first two digit from 20.... to 21....

FEMALE STUD COUPLING

Thread BSP Parallel

Type: 2006...3

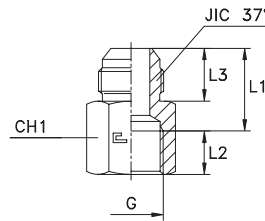

Series JIC	20.... [bar]	21.... [bar]	Ordering Complete	Ø Tube M	Ø Tube W	G	L1	L2	L3	CH1	JIC 37°	
UNIVERSAL	350	350	200601.3	6	1/4	1/8	20	10	13,9	14	7/16-20	
			200602.3	8	5/16	1/8	20	10	13,9	14	1/2-20	
			200603.3	10	3/8	1/4	21	14	14	19	9/16-18	
			200604.3	12	1/2	3/8	25	14	16,7	22	3/4-16	
	315	315	200605.3	14-15-16	5/8	1/2	28,5	17	19,3	30	7/8-14	
			200606.3	18-20	3/4	3/4	32	19	21,9	36	1 1/16-12	
	290	290	200607.3	25	1	1	32,5	21,5	23,1	41	1 5/16-12	
	240	240	200608.3	30-32	1 1/4	1 1/4	37	23,5	24,3	50	1 5/8-12	
			200609.3		1 1/2	1 1/2	40	25,5	27,5	60	1 7/8-12	
	350	350	200610.3	6	1/4	1/4	21	14	13,9	19	7/16-20	
			200611.3	8	5/16	1/4	21	14	13,9	19	1/2-20	
			200612.3	10	3/8	3/8	22	14	14	22	9/16-18	
			200613.3	10	3/8	1/2	23,5	17	14	30	9/16-18	
			200614.3	12	1/2	1/4	25	14	16,7	22	3/4-16	
			200615.3	12	1/2	1/2	26	17	16,7	30	3/4-16	
	240	240	200616.3	18-20	3/4	1/2	31	17	21,9	30	1 1/16-12	
			200617.3	30-32	1 1/4	1	34	21,5	24,3	46	1 5/8-12	
				200618.3	38	1 1/2	1 1/4	40,5	23,5	27,5	50	1 7/8-12

Notes: If you wish to order a fitting in stainless steel, please change the first two digit from 20.... to 21.....

FEMALE STUD COUPLING

Thread NPTF

Type: 2007...3

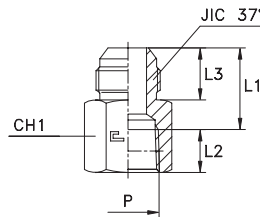

Series JIC	20.... [bar]	21.... [bar]	Ordering Complete	Ø Tube M	Ø Tube W	P	L1	L2	L3	CH1	JIC 37°
UNIVERSAL	350	350	200701.3	6	1/4	1/8	20,5	9,5	13,9	14	7/16-20
			200702.3	8	5/16	1/8	20,5	9,5	13,9	14	1/2-20
			200703.3	10	3/8	1/4	21,5	14	14	19	9/16-18
			200704.3	12	1/2	3/8	25	14,5	16,7	22	3/4-16
	315	315	200705.3	14-15-16	5/8	1/2	29	19	19,3	30	7/8-14
			200706.3	18-20	3/4	3/4	32,5	19,5	21,9	36	1 1/16-12
	290	290	200707.3	25	1	1	36	23,5	23,1	41	1 5/16-12
	240	240	200708.3	30-32	1 1/4	1 1/4	39,5	24	24,3	50	1 5/8-12
			200709.3	38	1 1/2	1 1/2	42,5	24	27,5	60	1 7/8-12
	350	350	200710.3	6	1/4	1/4	21,5	14	13,9	19	7/16-20
			200711.3	8	5/16	1/4	21,5	14	13,9	19	1/2-20
			200712.3	10	3/8	3/8	22,5	14,5	14	22	9/16-18
			200713.3	12	1/2	1/4	25,5	14	16,7	22	3/4-16
			200714.3	12	1/2	1/2	26,5	19	16,7	30	3/4-16
			200715.3	18-20	3/4	1/2	32	19	21,9	30	1 1/16-12

Notes: If you wish to order a fitting in stainless steel, please change the first two digit from 20.... to 21.....
Articles available on scheduled orders only.

DFEMALE STUD COUPLING

Thread BSPT - Thread NPTF

Type: 2008...3

Type: 2009...3

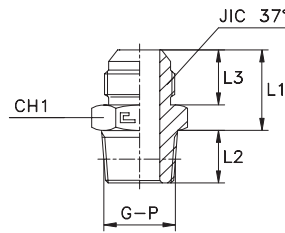

Series JIC	20.... [bar]	21.... [bar]	Ordering Complete	Ø Tube M	Ø Tube W	G	L1	L2	L3	CH1	JIC 37°	
UNIVERSAL	350	350	200801.3	6	1/4	1/8	21	10	13,9	14	7/16-20	
			200802.3	8	5/16	1/8	21	10	13,9	14	1/2-20	
			200803.3	10	3/8	1/4	22	14,5	14	17	9/16-18	
			200804.3	12	1/2	3/8	24,5	14,5	16,7	22	3/4-16	
			200805.3	14-15-16	5/8	1/2	29	19	19,3	24	7/8-14	
				200806.3	18-20	3/4	3/4	33,5	19	21,9	30	1 1/16-12
	290	290	200807.3	25	1	1	34,5	24	23,1	36	15/16-12	
	240	240	200808.3	30-32	1 1/4	1 1/4	37	25	24,3	46	15/8-12	
			200809.3	38	1 1/2	1 1/2	42	26	27,5	50	1 7/8-12	
	350	350	200810.3	6	1/4	1/4	21	14,5	13,9	14	7/16-20	
			200811.3	8	5/16	1/4	21	14,5	13,9	14	1/2-20	
			200812.3	10	3/8	1/8	22	10	14	17	9/16-18	
			200813.3	10	3/8	3/8	22	14,5	14	17	9/16-18	
			200814.3	10	3/8	1/2	22	19	14	22	9/16-18	
			200815.3	12	1/2	1/4	24,5	14,5	16,7	22	3/4-16	
			200816.3	12	1/2	1/2	24,5	19	16,7	22	3/4-16	
			200817.3	12	1/2	3/4	27	19	16,7	27	3/4-16	
			200818.3	14-15-16	5/8	3/8	29	14,5	19,3	24	7/8-14	
			200819.3	14-15-16	5/8	3/4	29,5	19	19,3	27	7/8-14	
			200820.3	18-20	3/4	1/2	33,5	19	21,9	30	1 1/16-12	
	290	290	200821.3	18-20	3/4	1	33,5	24	21,9	36	1 1/16-12	
			200822.3	25	1	3/4	34,5	19	23,1	36	15/16-12	
	240	240	200823.3	30-32	1 1/4	1	37,5	24	24,3	46	15/8-12	
			200824.3	38	1 1/2	1 1/4	42,5	25	27,5	50	1 7/8-12	

Notes: If you wish to order a fitting in stainless steel, please change the first two digit from 20.... to 21....

Series JIC	20.... [bar]	21.... [bar]	Ordering Complete	Ø Tube M	Ø Tube W	P	L1	L2	L3	CH1	JIC 37°	
UNIVERSAL	350	350	200901.3	6	1/4	1/8	21	10	13,9	14	7/16-20	
			200902.3	8	5/16	1/8	21	10	13,9	14	1/2-20	
			200903.3	10	3/8	1/4	22	14,5	14	17	9/16-18	
			200904.3	12	1/2	3/8	24,5	14,5	16,7	22	3/4-16	
			200905.3	14-15-16	5/8	1/2	29	19	19,3	24	7/8-14	
				200906.3	18-20	3/4	3/4	33,5	19	21,9	30	1 1/16-12
	290	290	200907.3	25	1	1	34,5	24	23,1	36	15/16-12	
	240	240	200908.3	30-32	1 1/4	1 1/4	37	25	24,3	46	15/8-12	
			200909.3	38	1 1/2	1 1/2	42	26	27,5	50	1 7/8-12	
	350	350	200910.3	6	1/4	1/4	21	14,5	13,9	14	7/16-20	
			200911.3	6	1/4	3/8	22	14,5	13,9	17	7/16-20	
			200912.3	6	1/4	1/2	22	19	13,9	22	7/16-20	
			200913.3	8	5/16	1/4	21	14,5	13,9	14	1/2-20	
			200914.3	10	3/8	1/8	22	10	14	17	9/16-18	
			200915.3	10	3/8	3/8	22	14,5	14	17	9/16-18	
			200916.3	10	3/8	1/2	22	19	14	22	9/16-18	
			200917.3	12	1/2	1/4	24,5	14,5	16,7	22	3/4-16	
			200918.3	12	1/2	1/2	24,5	19	16,7	22	3/4-16	
			200919.3	12	1/2	3/4	27	19	16,7	27	3/4-16	
			200920.3	14-15-16	5/8	3/8	29	14,5	19,3	24	7/8-14	
	200921.3	14-15-16	5/8	3/4	29,5	19	19,3	27	7/8-14			
	200922.3	18-20	3/4	1/2	33,5	19	21,9	30	1 1/16-12			
	290	290	200923.3	18-20	3/4	1	33,5	24	21,9	36	1 1/16-12	
			200924.3	25	1	3/4	34,5	19	23,1	36	15/16-12	
	240	240	200925.3	30-32	1 1/4	1	37	24	24,3	46	15/8-12	
			200926.3	38	1 1/2	1 1/4	42,5	25	27,5	50	1 7/8-12	

Notes: If you wish to order a fitting in stainless steel, please change the first two digit from 20.... to 21....

MALE STUD ELBOW

Thread BSP Taper - Thread NPTF

Type: 2010...3

Type: 2011...3

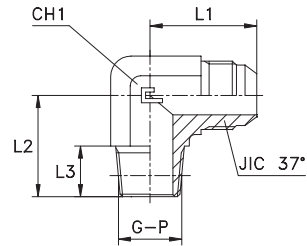

Series JIC	20.... [bar]	21.... [bar]	Ordering Complete	Ø Tube M	Ø Tube W	G	L1	L2	L3	CH1	JIC 37°		
UNIVERSAL	350	350	201001.3	6	1/4	1/8	23	20	10	11	7/16-20		
			201002.3	8	5/16	1/8	24	20	10	14	1/2-20		
			201003.3	10	3/8	1/4	27,5	28	14,5	14	9/16-18		
			201004.3	12	1/2	3/8	32	31	14,5	19	3/4-16		
			201005.3	14-15-16	5/8	1/2	37	37,5	19	22	7/8-14		
	201006.3	18-20	3/4	3/4	42	40	19	27	1 1/16-12				
	290	290	201007.3	25	1	1	46	50	24	33	15/16-12		
	240	240	201008.3	30-32	1 1/4	1 1/4	53	60	25	41	15/8-12		
			201009.3	38	1 1/2	1 1/2	59	67	26	48	1 7/8-12		
	350	350	201010.3	6	1/4	1/4	24	28	14,5	14	7/16-20		
			201011.3	8	5/16	1/4	24	28	14,5	14	1/2-20		
			201012.3	10	3/8	1/8	27,5	20	10	14	9/16-18		
			201013.3	10	3/8	3/8	29,5	31	14,5	19	9/16-18		
			201014.3	10	3/8	1/2	31,5	37,5	19	22	9/16-18		
			201015.3	12	1/2	1/4	32	31	14,5	19	3/4-16		
			201016.3	12	1/2	1/2	34	37,5	19	22	3/4-16		
			201017.3	12	1/2	3/4	36	40	19	27	3/4-16		
			201018.3	14-15-16	5/8	3/8	37	31	14,5	22	7/8-14		
			201019.3	14-15-16	5/8	3/4	39	40	19	27	7/8-14		
			201020.3	18-20	3/4	1/2	42	37,5	19	27	1 1/16-12		
			290	290	201021.3	18-20	3/4	1	45	50	24	33	1 1/16-12
					201022.3	25	1	3/4	46	40	19	33	15/16-12
	240	240	201023.3	30-32	1 1/4	1	53	51	24	41	15/8-12		

Notes: If you wish to order a fitting in stainless steel, please change the first two digit from 20.... to 21....

Series JIC	20.... [bar]	21.... [bar]	Ordering Complete	Ø Tube M	Ø Tube W	P	L1	L2	L3	CH1	JIC 37°
UNIVERSAL	350	350	201101.3	6	1/4	1/8	23	20	10	11	7/16-20
			201102.3	8	5/16	1/8	24	20	10	14	1/2-20
			201103.3	10	3/8	1/4	27,5	28	14,5	14	9/16-18
			201104.3	12	1/2	3/8	32	31	14,5	19	3/4-16
			201105.3	14-15-16	5/8	1/2	37	37,5	19	22	7/8-14
	201106.3	18-20	3/4	3/4	42	40	19	27	1 1/16-12		
	290	290	201107.3	25	1	1	46	50	24	33	15/16-12
	240	240	201108.3	30-32	1 1/4	1 1/4	53	60	25	41	15/8-12
			201109.3	38	1 1/2	1 1/2	59	67	26	48	1 7/8-12
	350	350	201110.3	6	1/4	1/4	24	28	14,5	14	7/16-20
			201111.3	6	1/4	3/8	29	31	14,5	19	7/16-20
			201112.3	6	1/4	1/2	31	37,5	19	22	7/16-20
			201113.3	8	5/16	1/4	24	28	14,5	14	1/2-20
			201114.3	10	3/8	1/8	27,5	20	10	14	9/16-18
			201115.3	10	3/8	3/8	29,5	31	14,5	19	9/16-18
			201116.3	10	3/8	1/2	31,5	37,5	19	22	9/16-18
			201117.3	12	1/2	1/4	32	31	14,5	19	3/4-16
			201118.3	12	1/2	1/2	34	37,5	19	22	3/4-16
			201119.3	12	1/2	3/4	36	40	19	27	3/4-16
			201120.3	14-15-16	5/8	3/8	37	31	14,5	22	7/8-14
			201121.3	14-15-16	5/8	3/4	39	40	19	27	7/8-14
			201122.3	18-20	3/4	1/2	42	37,5	19	27	1 1/16-12
	290	290	201123.3	18-20	3/4	1	45	50	24	33	1 1/16-12
			201124.3	25	1	3/4	46	40	19	33	15/16-12
240	240	201125.3	25	1	1 1/4	52	60	25	41	15/16-12	
		201126.3	30-32	1 1/4	1	53	51	24	41	15/8-12	
		201127.3	30-32	1 1/4	1 1/2	55	67	26	48	15/8-12	
		201128.3	38	1 1/2	1 1/4	59	66	25	48	1 7/8-12	

Notes: If you wish to order a fitting in stainless steel, please change the first two digit from 20.... to 21....

MALE STUD ELBOW 45°
Thread BSP Taper - Thread NPTF

Type: 2012...3
Type: 2013...3

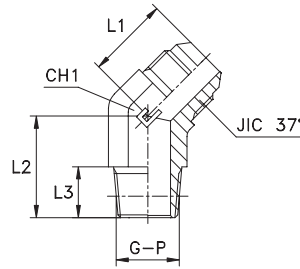

Series JIC	20.... [bar]	21.... [bar]	Ordering Complete	Ø Tube M	Ø Tube W	G	L1	L2	L3	CH1	JIC 37°
UNIVERSAL	350	350	201201.3	6	1/4	1/8	19,5	16,5	10	11	7/16-20
			201202.3	8	5/16	1/8	20	16,5	10	14	1/2-20
			201203.3	10	3/8	1/4	21,5	22	14,5	14	9/16-18
			201204.3	12	1/2	3/8	25,5	24	14,5	19	3/4-16
			201205.3	14-15-16	5/8	1/2	29	29,5	19	22	7/8-14
	201206.3	18-20	3/4	3/4	33	30,5	19	27	1 1/16-12		
	290	290	201207.3	25	1	1	38	38	24	33	1 5/16-12
	240	240	201208.3	30-32	1 1/4	1 1/4	40	42	25	41	1 5/8-12
			201209.3	38	1 1/2	1 1/2	46	45	26	48	1 7/8-12
	350	350	201210.3	6	1/4	1/4	20	22	14,5	14	7/16-20
			201211.3	8	5/16	1/4	20	22	14,5	14	1/2-20
			201212.3	10	3/8	1/8	21,5	16,5	10	14	9/16-18
			201213.3	10	3/8	3/8	23	24	14,5	19	9/16-18
			201214.3	10	3/8	1/2	23,5	29,5	19	22	9/16-18
			201215.3	12	1/2	1/4	25,5	24	14,5	19	3/4-16
			201216.3	12	1/2	1/2	26	29,5	19	22	3/4-16
			201217.3	12	1/2	3/4	27	30,5	19	27	3/4-16
			201218.3	14-15-16	5/8	3/8	29	25,5	14,5	22	7/8-14
			201219.3	14-15-16	5/8	3/4	30	30,5	19	27	7/8-14
	201220.3	18-20	3/4	1/2	33	30,5	19	27	1 1/16-12		
	290	290	201221.3	18-20	3/4	1	37	38	24	33	1 1/16-12
			201222.3	25	1	3/4	38	33	19	33	1 5/16-12
	240	240	201223.3	30-32	1 1/4	1	40	41	24	41	1 5/8-12

Notes: If you wish to order a fitting in stainless steel, please change the first two digit from 20.... to 21.... .
Articles available on scheduled orders only.

Series JIC	20.... [bar]	21.... [bar]	Ordering Complete	Ø Tube M	Ø Tube W	P	L1	L2	L3	CH1	JIC 37°
UNIVERSAL	350	350	201301.3	6	1/4	1/8	19,5	16,5	10	11	7/16-20
			201302.3	8	5/16	1/8	20	16,5	10	14	1/2-20
			201303.3	10	3/8	1/4	21,5	22	14,5	14	9/16-18
			201304.3	12	1/2	3/8	25,5	24	14,5	19	3/4-16
			201305.3	14-15-16	5/8	1/2	29	29,5	19	22	7/8-14
	201306.3	18-20	3/4	3/4	33	30,5	19	27	1 1/16-12		
	290	290	201307.3	25	1	1	38	38	24	33	1 5/16-12
	240	240	201308.3	30-32	1 1/4	1 1/4	40	42	25	41	1 5/8-12
			201309.3	38	1 1/2	1 1/2	46	45	26	48	1 7/8-12
	350	350	201310.3	6	1/4	1/4	20	22	14,5	14	7/16-20
			201311.3	8	5/16	1/4	20	22	14,5	14	1/2-20
			201312.3	10	3/8	1/8	21,5	16,5	10	14	9/16-18
			201313.3	10	3/8	3/8	23	24	14,5	19	9/16-18
			201314.3	10	3/8	1/2	23,5	29,5	19	22	9/16-18
			201315.3	12	1/2	1/4	25,5	24	14,5	19	3/4-16
			201316.3	12	1/2	1/2	26	29,5	19	22	3/4-16
			201317.3	12	1/2	3/4	27	30,5	19	27	3/4-16
			201318.3	14-15-16	5/8	3/8	29	25,5	14,5	22	7/8-14
			201319.3	14-15-16	5/8	3/4	30	30,5	19	27	7/8-14
	201320.3	18-20	3/4	1/2	33	30,5	19	27	1 1/16-12		
	290	290	201321.3	18-20	3/4	1	37	38	24	33	1 1/16-12
			201322.3	25	1	3/4	38	33	19	33	1 5/16-12
	240	240	201323.3	30-32	1 1/4	1	40	41	24	41	1 5/8-12

Notes: If you wish to order a fitting in stainless steel, please change the first two digit from 20.... to 21.... .
Articles available on scheduled orders only.

MALE STUD BARREL TEE

Thread BSP Taper - Thread NPTF

Type: 2014...3
Type: 2015...3

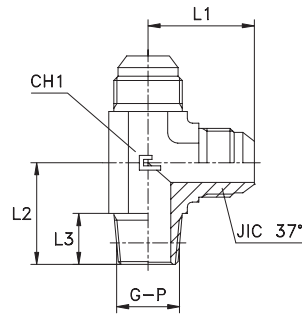

Series JIC	20.... [bar]	21.... [bar]	Ordering Complete	Ø Tube M	Ø Tube W	G	L1	L2	L3	CH1	JIC 37°
UNIVERSAL	350	350	201401.3	6	1/4	1/8	23	20	10	11	7/16-20
			201402.3	8	5/16	1/8	24	20	10	14	1/2-20
			201403.3	10	3/8	1/4	27,5	28	14,5	14	9/16-18
			201404.3	12	1/2	3/8	32	31	14,5	19	3/4-16
			201405.3	14-15-16	5/8	1/2	37	37,5	19	22	7/8-14
	201406.3	18-20	3/4	3/4	42	40	19	27	1 1/16-12		
	290	290	201407.3	25	1	1	46	50	24	33	1 5/16-12
	240	240	201408.3	30-32	1 1/4	1 1/4	53	60	25	41	1 5/8-12
			201409.3	38	1 1/2	1 1/2	59	67	26	48	1 7/8-12
	350	350	201410.3	6	1/4	1/4	24	28	14,5	14	7/16-20
			201411.3	8	5/16	1/4	24	28	14,5	14	1/2-20
			201412.3	10	3/8	3/8	29,5	31	14,5	19	9/16-18
			201413.3	12	1/2	1/2	34	37,5	19	22	3/4-16
			201414.3	14-15-16	5/8	3/8	37	31	14,5	22	7/8-14
			201415.3	14-15-16	5/8	3/4	39	40	19	27	7/8-14
	201416.3	18-20	3/4	1/2	42	37,5	19	27	1 1/16-12		
	290	290	201417.3	25	1	3/4	46	40	19	33	1 5/16-12
	240	240	201418.3	30-32	1 1/4	1	53	51	24	41	1 5/8-12

Notes: If you wish to order a fitting in stainless steel, please change the first two digit from 20.... to 21.... .
Articles available on scheduled orders only.

Series JIC	20.... [bar]	21.... [bar]	Ordering Complete	Ø Tube M	Ø Tube W	P	L1	L2	L3	CH1	JIC 37°
UNIVERSAL	350	350	201501.3	6	1/4	1/8	23	20	10	11	7/16-20
			201502.3	8	5/16	1/8	24	20	10	14	1/2-20
			201503.3	10	3/8	1/4	27,5	28	14,5	14	9/16-18
			201504.3	12	1/2	3/8	32	31	14,5	19	3/4-16
			201505.3	14-15-16	5/8	1/2	37	37,5	19	22	7/8-14
	201506.3	18-20	3/4	3/4	42	40	19	27	1 1/16-12		
	290	290	201507.3	25	1	1	46	50	24	33	1 5/16-12
	240	240	201508.3	30-32	1 1/4	1 1/4	53	60	25	41	1 5/8-12
			201509.3	38	1 1/2	1 1/2	59	67	26	48	1 7/8-12
	350	350	201510.3	6	1/4	1/4	24	28	14,5	14	7/16-20
			201511.3	8	5/16	1/4	24	28	14,5	14	1/2-20
			201512.3	10	3/8	3/8	29,5	31	14,5	19	9/16-18
			201513.3	12	1/2	1/2	34	37,5	19	22	3/4-16
			201514.3	14-15-16	5/8	3/8	37	31	14,5	22	7/8-14
			201515.3	14-15-16	5/8	3/4	39	40	19	27	7/8-14
	201516.3	18-20	3/4	1/2	42	37,5	19	27	1 1/16-12		
	290	290	201517.3	25	1	3/4	46	40	19	33	1 5/16-12
	240	240	201518.3	30-32	1 1/4	1	53	51	24	41	1 5/8-12

Notes: If you wish to order a fitting in stainless steel, please change the first two digit from 20.... to 21.... .
Articles available on scheduled orders only.

MALE STUD BRANCH TEE

Thread BSP Taper - Thread NPTF

Type: 2016...3
Type: 2017...3

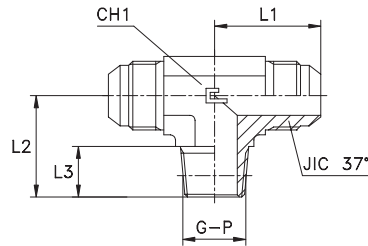

Series JIC	20.... [bar]	21.... [bar]	Ordering Complete	Ø Tube M	Ø Tube W	G	L1	L2	L3	CH1	JIC 37°
UNIVERSAL	350	350	201601.3	6	1/4	1/8	23	20	10	11	7/16-20
			201602.3	8	5/16	1/8	24	20	10	14	1/2-20
			201603.3	10	3/8	1/4	27,5	28	14,5	14	9/16-18
			201604.3	12	1/2	3/8	32	31	14,5	19	3/4-16
			201605.3	14-15-16	5/8	1/2	37	37,5	19	22	7/8-14
			201606.3	18-20	3/4	3/4	42	40	19	27	1 1/16-12
	290	290	201607.3	25	1	1	46	50	24	33	1 5/16-12
	240	240	201608.3	30-32	1 1/4	1 1/4	53	60	25	41	1 5/8-12
			201609.3	38	1 1/2	1 1/2	59	67	26	48	1 7/8-12
	350	350	201610.3	6	1/4	1/4	24	28	14,5	14	7/16-20
			201611.3	8	5/16	1/4	24	28	14,5	14	1/2-20
			201612.3	10	3/8	3/8	29,5	31	14,5	19	9/16-18
			201613.3	12	1/2	1/2	34	37,5	19	22	3/4-16
			201614.3	14-15-16	5/8	3/8	37	31	14,5	22	7/8-14
			201615.3	14-15-16	5/8	3/4	39	40	19	27	7/8-14
	201616.3	18-20	3/4	1/2	42	37,5	19	27	1 1/16-12		
	290	290	201617.3	25	1	3/4	46	40	19	33	1 5/16-12
	240	240	201618.3	30-32	1 1/4	1	53	59	24	41	1 5/8-12

Notes: If you wish to order a fitting in stainless steel, please change the first two digit from 20.... to 21.... .
Articles available on scheduled orders only.

Series JIC	20.... [bar]	21.... [bar]	Ordering Complete	Ø Tube M	Ø Tube W	P	L1	L2	L3	CH1	JIC 37°
UNIVERSAL	350	350	201701.3	6	1/4	1/8	23	20	10	11	7/16-20
			201702.3	8	5/16	1/8	24	20	10	14	1/2-20
			201703.3	10	3/8	1/4	27,5	28	14,5	14	9/16-18
			201704.3	12	1/2	3/8	32	31	14,5	19	3/4-16
			201705.3	14-15-16	5/8	1/2	37	37,5	19	22	7/8-14
			201706.3	18-20	3/4	3/4	42	40	19	27	1 1/16-12
	290	290	201707.3	25	1	1	46	50	24	33	1 5/16-12
	240	240	201708.3	30-32	1 1/4	1 1/4	53	60	25	41	1 5/8-12
			201709.3	38	1 1/2	1 1/2	59	67	26	48	1 7/8-12
	350	350	201710.3	6	1/4	1/4	24	28	14,5	14	7/16-20
			201711.3	8	5/16	1/4	24	28	14,5	14	1/2-20
			201712.3	10	3/8	3/8	29,5	31	14,5	19	9/16-18
			201713.3	12	1/2	1/2	34	37,5	19	22	3/4-16
			201714.3	14-15-16	5/8	3/8	37	31	14,5	22	7/8-14
			201715.3	14-15-16	5/8	3/4	39	40	19	27	7/8-12
	201716.3	18-20	3/4	1/2	42	37,5	19	27	1 1/16-12		
	290	290	201717.3	25	1	3/4	46	40	19	33	1 5/16-12
	240	240	201718.3	30-32	1 1/4	1	53	51	24	41	1 5/8-12

Notes: If you wish to order a fitting in stainless steel, please change the first two digit from 20.... to 21.... .
Articles available on scheduled orders only.

FEMALE BULKHEAD CONNECTION

Thread BSP Parallel

Type: **2018...3**

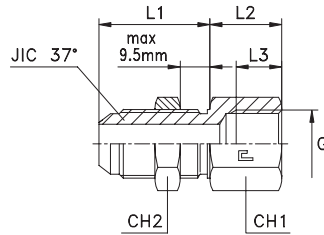

Series JIC	20.... [bar]	21.... [bar]	Ordering Complete	Ø Tube M	Ø Tube W	G	L1	L2	L3	CH1	CH2	JIC 37°
UNIVERSAL	350	350	201801.3	6	1/4	1/8	31,5	16	10	17	17	7/16-20
			201802.3	8	5/16	1/8	31,5	16	10	19	19	1/2-20
			201803.3	10	3/8	1/4	33,5	21	14	22	22	9/16-18
			201804.3	12	1/2	3/8	37,6	22,4	14	24	24	3/4-16
			201805.3	14-15-16	5/8	1/2	41,1	26,4	17	30	30	7/8-14
	315	315	201806.3	18-20	3/4	3/4	45,4	29,1	19	36	36	1 1/16-12
	290	290	201807.3	25	1	1	45,4	31,1	21,5	41	41	1 5/16-12
	240	240	201808.3	30-32	1 1/4	1 1/4	46,7	36,3	23,5	50	50	1 5/8-12
			201809.3	38	1 1/2	1 1/2	47	38	25,5	60	55	1 7/8-12
	350	350	201810.3	6	1/4	1/4	31,5	21	14	19	17	7/16-20
			201811.3	8	5/16	1/4	31,5	21	14	19	19	1/2-20
			201812.3	10	3/8	1/8	33,5	16	10	17	22	9/16-18
			201813.3	10	3/8	3/8	33,5	22,5	14	24	22	9/16-18
			201814.3	12	1/2	1/4	37,6	21,4	14	22	24	3/4-16
			201815.3	12	1/2	1/2	37,6	26,4	17	30	24	3/4-16
			201816.3	18-20	3/4	1/2	45,4	26,6	17	30	36	1 1/16-12

Notes: If you wish to order a fitting in stainless steel, please change the first two digit from **20....** to **21....** .
Articles available on scheduled orders only.

FEMALE BULKHEAD CONNECTION

Thread NPTF

Type: **2019...3**

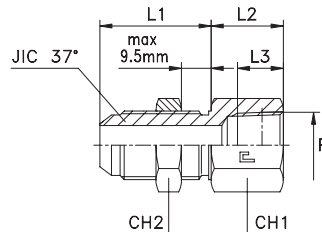

Series JIC	20.... [bar]	21.... [bar]	Ordering Complete	Ø Tube M	Ø Tube W	P	L1	L2	L3	CH1	CH2	JIC 37°
UNIVERSAL	350	350	201901.3	6	1/4	1/8	31,5	16	9,5	17	17	7/16-20
			201902.3	8	5/16	1/8	31,5	16	9,5	19	19	1/2-20
			201903.3	10	3/8	1/4	33,5	21,5	14	22	22	9/16-18
			201904.3	12	1/2	3/8	37,6	22,9	14,5	24	24	3/4-16
			201905.3	14-15-16	5/8	1/2	41,1	28,9	19	30	30	7/8-14
	315	315	201906.3	18-20	3/4	3/4	45,4	30,1	19,5	36	36	1 1/16-12
	290	290	201907.3	25	1	1	45,4	36,6	23,5	41	41	1 5/16-12
	240	240	201908.3	30-32	1 1/4	1 1/4	46,7	39,3	24	50	50	1 5/8-12
			201909.3	38	1 1/2	1 1/2	47	39	24	60	55	1 7/8-12
	350	350	201910.3	6	1/4	1/4	31,5	21	14	19	17	7/16-20
			201911.3	8	5/16	1/4	31,5	21	14	19	19	1/2-20
			201912.3	10	3/8	1/8	33,5	16	9,5	17	22	9/16-18
			201913.3	10	3/8	3/8	33,5	22,5	14,5	24	22	9/16-18
			201914.3	12	1/2	1/4	37,6	21,4	14	22	24	3/4-16
			201915.3	12	1/2	1/2	37,6	26,4	19	30	24	3/4-16
			201916.3	18-20	3/4	1/2	45,4	26,6	19	30	36	1 1/16-12

Notes: If you wish to order a fitting in stainless steel, please change the first two digit from **20....** to **21....** .
Articles available on scheduled orders only.

BULKHEAD CONNECTION

Type: 2020...3

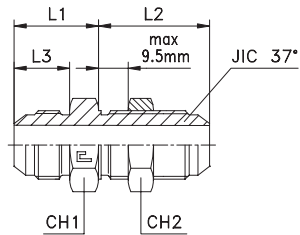

Series JIC	20.... [bar]	21.... [bar]	Ordering Complete	Ø Tube M	Ø Tube W	L1	L2	L3	CH1	CH2	JIC 37°
UNIVERSAL	450	450	202001.3	6	1/4	21	31,5	13,9	17	17	7/16-20
			202002.3	8	5/16	21	31,5	13,9	19	19	1/2-20
	350	350	202003.3	10	3/8	22	33,5	14	22	22	9/16-18
			202004.3	12	1/2	24,4	37,6	16,7	24	24	3/4-16
			202005.3	14-15-16	5/8	28,4	41,1	19,3	30	30	7/8-14
			202006.3	18-20	3/4	33,1	45,4	21,9	36	36	1 1/16-12
	290	290	202007.3	25	1	34,6	45,4	23,1	41	41	15/16-12
	240	240	202008.3	30-32	1 1/4	37,3	46,7	24,3	50	50	15/8-12
			202009.3	38	1 1/2	42,5	47	27,5	55	55	1 7/8-12

Notes: If you wish to order a fitting in stainless steel, please change the first two digit from 20.... to 21.... .

BULKHEAD ELBOW

Type: 2021...3

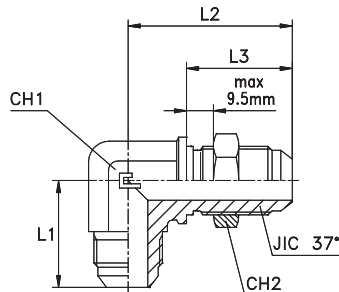

Series JIC	20.... [bar]	21.... [bar]	Ordering Complete	Ø Tube M	Ø Tube W	L1	L2	L3	CH1	CH2	JIC 37°
UNIVERSAL	450	450	202101.3	6	1/4	24,5	40,5	28,3	11	17	7/16-20
			202102.3	8	5/16	27	43,5	28,3	14	19	1/2-20
	350	350	202103.3	10	3/8	27,5	46	30,1	14	22	9/16-18
			202104.3	12	1/2	34,5	53,5	35	19	24	3/4-16
			202105.3	14-15-16	5/8	39,5	60,5	38,5	22	30	7/8-14
			202106.3	18-20	3/4	45	68	42,8	27	36	1 1/16-12
	290	290	202107.3	25	1	49,5	71	42,8	33	41	15/16-12
	240	240	202108.3	30-32	1 1/4	55	79	44,1	41	50	15/8-12
			202109.3	38	1 1/2	59,5	87	44,3	48	55	1 7/8-12

Notes: If you wish to order a fitting in stainless steel, please change the first two digit from 20.... to 21.... .
Articles available on scheduled orders only.

45° BULKHEAD ELBOW

Type: 2022...3

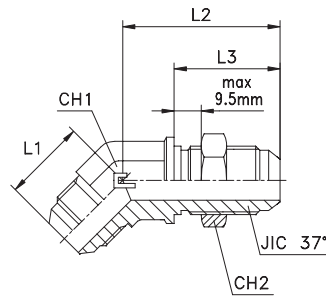

Series JIC	20.... [bar]	21.... [bar]	Ordering Complete	Ø Tube M	Ø Tube W	L1	L2	L3	CH1	CH2	JIC 37°
UNIVERSAL	450	450	202201.3	6	1/4	19,5	39	28,3	11	17	7/16-20
			202202.3	8	5/16	20	41	28,3	14	19	1/2-20
	350	350	202203.3	10	3/8	21,5	43	30,1	14	22	9/16-18
			202204.3	12	1/2	25,5	49,5	35	19	24	3/4-16
			202205.3	14-15-16	5/8	29	55	38,5	22	30	7/8-14
			202206.3	18-20	3/4	33	62	42,8	27	36	1 1/16-12
	290	290	202207.3	25	1	38	65	42,8	33	41	15/16-12
	240	240	202208.3	30-32	1 1/4	40	67	44,1	41	50	1 5/8-12
			202209.3	38	1 1/2	46	68	44,3	48	55	1 7/8-12

Notes: If you wish to order a fitting in stainless steel, please change the first two digit from 20.... to 21....
Articles available on request only.

BULKHEAD BRANCH TEE

Type: 2023...3

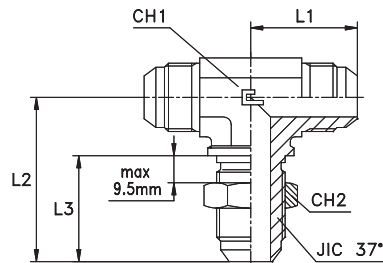

Series JIC	20.... [bar]	21.... [bar]	Ordering Complete	Ø Tube M	Ø Tube W	L1	L2	L3	CH1	CH2	JIC 37°
UNIVERSAL	450	450	202301.3	6	1/4	24,5	40,5	28,3	11	17	7/16-20
			202302.3	8	5/16	27	43,5	28,3	14	19	1/2-20
	350	350	202303.3	10	3/8	27,5	46	30,1	14	22	9/16-18
			202304.3	12	1/2	34,5	53,5	35	19	24	3/4-16
			202305.3	14-15-16	5/8	39,5	60,5	38,5	22	30	7/8-14
			202306.3	18-20	3/4	45	68	42,8	27	36	1 1/16-12
	290	290	202307.3	25	1	49,5	71	42,8	33	41	15/16-12
	240	240	202308.3	30-32	1 1/4	55	79	44,1	41	50	1 5/8-12
			202309.3	38	1 1/2	59,5	87	44,3	48	55	1 7/8-12

Notes: If you wish to order a fitting in stainless steel, please change the first two digit from 20.... to 21....
Articles available on request only.

STRAIGHT COUPLING

Type: 2024...3

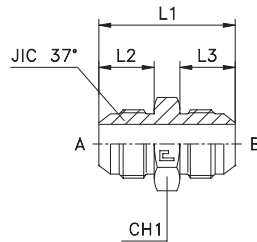

Series JIC	20.... [bar]	21.... [bar]	Ordering Complete	Ø Tube A ^M	Ø Tube B ^M	Ø Tube A ^W	Ø Tube B ^W	L1	L2	L3	CH1	JIC 37° A	JIC 37° B
UNIVERSAL	450	450	202401.3	6	6	1/4	1/4	35	13,9	13,9	12	7/16-20	7/16-20
			202402.3	8	8	5/16	5/16	35	13,9	13,9	14	1/2-20	1/2-20
	350	350	202403.3	10	10	3/8	3/8	36	14	14	17	9/16-18	9/16-18
			202404.3	12	12	1/2	1/2	41	16,7	16,7	22	3/4-16	3/4-16
			202405.3	14-15-16	14-15-16	5/8	5/8	48	19,3	19,3	24	7/8-14	7/8-14
			202406.3	18-20	18-20	3/4	3/4	55	21,9	21,9	30	1 1/16-12	1 1/16-12
	290	290	202407.3	25	25	1	1	57	23,1	23,1	36	1 5/16-12	1 5/16-12
	240	240	202408.3	30-32	30-32	1 1/4	1 1/4	61,5	24,3	24,3	46	1 5/8-12	1 5/8-12
			202409.3	38	38	1 1/2	1 1/2	70	27,5	27,5	50	1 7/8-12	1 7/8-12
	350	350	202410.3	10	6	3/8	1/4	36	14	13,9	17	9/16-18	7/16-20
			202411.3	12	10	1/2	3/8	38,5	16,7	14	22	3/4-16	9/16-18
			202412.3	14-15-16	12	5/8	1/2	45,5	19,3	16,7	24	7/8-14	3/4-16
			202413.3	18-20	12	3/4	1/2	50	21,9	16,7	30	1 1/16-12	3/4-16
	290	290	202414.3	18-20	14-15-16	3/4	5/8	52,5	21,9	19,3	30	1 1/16-12	7/8-14
			202415.3	25	18-20	1	3/4	56	23,1	21,9	36	1 5/16-12	1 1/16-12

Notes: If you wish to order a fitting in stainless steel, please change the first two digit from 20.... to 21....

EQUAL ELBOW

Type: 2025...3

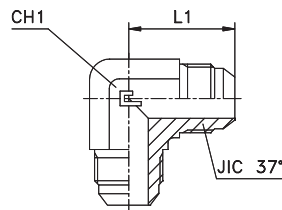

Series JIC	20.... [bar]	21.... [bar]	Ordering Complete	Ø Tube M	Ø Tube W	L1	CH1	JIC 37°
UNIVERSAL	450	450	202501.3	6	1/4	23	11	7/16-20
			202502.3	8	5/16	24	14	1/2-20
	350	350	202503.3	10	3/8	27,5	14	9/16-18
			202504.3	12	1/2	32	19	3/4-16
			202505.3	14-15-16	5/8	37	22	7/8-14
			202506.3	18-20	3/4	42	27	1 1/16-12
	290	290	202507.3	25	1	46	33	1 5/16-12
	240	240	202508.3	30-32	1 1/4	53	41	1 5/8-12
			202509.3	38	1 1/2	59	48	1 7/8-12

Notes: If you wish to order a fitting in stainless steel, please change the first two digit from 20.... to 21....

EQUAL TEE

Type: 2026...3

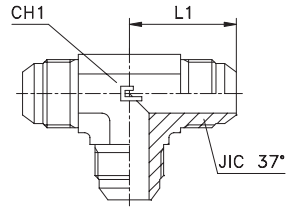

Series JIC	20.... [bar]	21.... [bar]	Ordering Complete	Ø Tube M	Ø Tube W	L1	CH1	JIC 37°
UNIVERSAL	450	450	202601.3	6	1/4	23	11	7/16-20
			202602.3	8	5/16	24	14	1/2-20
	350	350	202603.3	10	3/8	27,5	14	9/16-18
			202604.3	12	1/2	32	19	3/4-16
			202605.3	14-15-16	5/8	37	22	7/8-14
			202606.3	18-20	3/4	42	27	1 1/16-12
	290	290	202607.3	25	1	46	33	1 5/16-12
	240	240	202608.3	30-32	1 1/4	53	41	1 5/8-12
			202609.3	38	1 1/2	59	48	1 7/8-12

Notes: If you wish to order a fitting in stainless steel, please change the first two digit from 20.... to 21.... .

EQUAL CROSS

Type: 2027...3

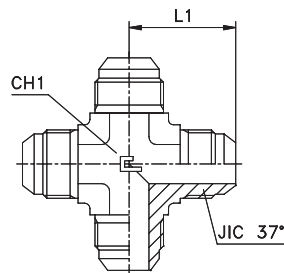

Series JIC	20.... [bar]	21.... [bar]	Ordering Complete	Ø Tube M	Ø Tube W	L1	CH1	JIC 37°
UNIVERSAL	450	450	202701.3	6	1/4	23	11	7/16-20
			202702.3	8	5/16	24	14	1/2-20
	350	350	202703.3	10	3/8	27,5	14	9/16-18
			202704.3	12	1/2	32	19	3/4-16
			202705.3	14-15-16	5/8	37	22	7/8-14
			202706.3	18-20	3/4	42	27	1 1/16-12
	290	290	202707.3	25	1	46	33	1 5/16-12
	240	240	202708.3	30-32	1 1/4	53	41	1 5/8-12
			202709.3	38	1 1/2	59	48	1 7/8-12

Notes: If you wish to order a fitting in stainless steel, please change the first two digit from 20.... to 21.... .
Articles available on scheduled orders only.

FEMALE STUD ELBOW

Thread BSP Parallel

Type: 2028...3

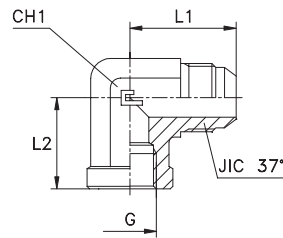

Series JIC	20.... [bar]	21.... [bar]	Ordering Complete	Ø Tube M	Ø Tube W	G	L1	L2	CH1	JIC 37°
UNIVERSAL	350	350	202801.3	6	1/4	1/8	27,5	17	14	7/16-20
			202802.3	8	5/16	1/8	27,5	17	14	1/2-20
			202803.3	10	3/8	1/4	31	22,5	19	9/16-18
			202804.3	12	1/2	3/8	36	26	22	3/4-16
			202805.3	14-15-16	5/8	1/2	42	31	27	7/8-14
	315	315	202806.3	18-20	3/4	3/4	48	34,5	33	1 1/16-12
	290	290	202807.3	25	1	1	55	41	41	1 5/16-12
	240	240	202808.3	30-32	1 1/4	1 1/4	59	43	48	1 5/8-12
			202809.3	38	1 1/2	1 1/2	73	53	65	1 7/8-12
	350	350	202810.3	6	1/4	1/4	29	22,5	19	7/16-20
			202811.3	8	5/16	1/4	29	22,5	19	1/2-20
			202812.3	10	3/8	1/8	27,5	17	14	9/16-18
			202813.3	10	3/8	3/8	31,5	26	22	9/16-18
			202814.3	12	1/2	1/4	32	22,5	19	3/4-16
			202815.3	12	1/2	1/2	36	31	27	3/4-16
	240	240	202816.3	18-20	3/4	1/2	42	31	27	1 1/16-12
			202817.3	30-32	1 1/4	1	55	41	41	1 5/8-12
			202818.3	38	1 1/2	1 1/4	59	43	48	1 7/8-12

Notes: If you wish to order a fitting in stainless steel, please change the first two digit from 20.... to 21.... .
Articles available on request only.

FEMALE STUD ELBOW

Thread NPTF

Type: 2029...3

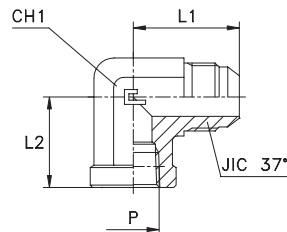

Series JIC	20.... [bar]	21.... [bar]	Ordering Complete	Ø Tube M	Ø Tube W	P	L1	L2	CH1	JIC 37°
UNIVERSAL	350	350	202901.3	6	1/4	1/8	27,5	17	14	7/16-20
			202902.3	8	5/16	1/8	27,5	17	14	1/2-20
			202903.3	10	3/8	1/4	31	22,5	19	9/16-18
			202904.3	12	1/2	3/8	36	26	22	3/4-16
			202905.3	14-15-16	5/8	1/2	42	31	27	7/8-14
	315	315	202906.3	18-20	3/4	3/4	48	34,5	33	1 1/16-12
	290	290	202907.3	25	1	1	55	41	41	1 5/16-12
	240	240	202908.3	30-32	1 1/4	1 1/4	59	43	48	1 5/8-12
			202909.3	38	1 1/2	1 1/2	73	53	65	1 7/8-12
	350	350	202910.3	6	1/4	1/4	29	22,5	19	7/16-20
			202911.3	8	5/16	1/4	29	22,5	19	1/2-20
			202912.3	10	3/8	1/8	27,5	17	14	9/16-18
			202913.3	10	3/8	3/8	31,5	26	22	9/16-18
			202914.3	12	1/2	1/4	32	22,5	19	3/4-16
			202915.3	12	1/2	1/2	36	31	27	3/4-16
	240	240	202916.3	18-20	3/4	1/2	42	31	27	1 1/16-12

Notes: If you wish to order a fitting in stainless steel, please change the first two digit from 20.... to 21.... .
Articles available on request only.

FEMALE STUD BRANCH TEE

Thread BSP Parallel

Type: 2032...3

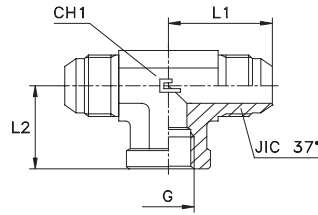

Series JIC	20.... [bar]	21.... [bar]	Ordering Complete	Ø Tube M	Ø Tube W	G	L1	L2	CH1	JIC 37°
UNIVERSAL	350	350	203201.3	6	1/4	1/8	27,5	17	14	7/16-20
			203202.3	8	5/16	1/8	27,5	17	14	1/2-20
			203203.3	10	3/8	1/4	31	22,5	19	9/16-18
			203204.3	12	1/2	3/8	36	26	22	3/4-16
			203205.3	14-15-16	5/8	1/2	42	31	27	7/8-14
	315	315	203206.3	18-20	3/4	3/4	48	34,5	33	1 1/16-12
	290	290	203207.3	25	1	1	55	41	41	1 5/16-12
	240	240	203208.3	30-32	1 1/4	1 1/4	59	43	48	1 5/8-12
			203209.3	38	1 1/2	1 1/2	73	53	65	1 7/8-12
	350	350	203210.3	6	1/4	1/4	29	22,5	19	7/16-20
			203211.3	8	5/16	1/4	29	22,5	19	1/2-20
			203212.3	10	3/8	1/8	27,5	17	14	9/16-18
			203213.3	10	3/8	3/8	31,5	26	22	9/16-18
			203214.3	12	1/2	1/4	32	22,5	19	3/4-16
			203215.3	12	1/2	1/2	36	31	27	3/4-16
	240	240	203216.3	18-20	3/4	1/2	42	31	27	1 1/16-12
			203217.3	30-32	1 1/4	1	55	41	41	1 5/8-12
			203218.3	38	1 1/2	1 1/4	59	43	48	1 7/8-12

Notes: If you wish to order a fitting in stainless steel, please change the first two digit from 20.... to 21....
Articles available on request only.

FEMALE STUD BRANCH TEEA

Thread NPTF

Type: 2033...3

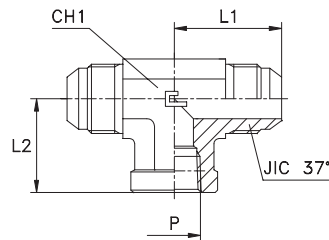

Series JIC	20.... [bar]	21.... [bar]	Ordering Complete	Ø Tube M	Ø Tube W	P	L1	L2	CH1	JIC 37°
UNIVERSAL	350	350	203301.3	6	1/4	1/8	27,5	17	14	7/16-20
			203302.3	8	5/16	1/8	27,5	17	14	1/2-20
			203303.3	10	3/8	1/4	31	22,5	19	9/16-18
			203304.3	12	1/2	3/8	36	26	22	3/4-16
			203305.3	14-15-16	5/8	1/2	42	31	27	7/8-14
	315	315	203306.3	18-20	3/4	3/4	48	34,5	33	1 1/16-12
	290	290	203307.3	25	1	1	55	41	41	1 5/16-12
	240	240	203308.3	30-32	1 1/4	1 1/4	59	43	48	1 5/8-12
			203309.3	38	1 1/2	1 1/2	73	53	65	1 7/8-12
	350	350	203310.3	6	1/4	1/4	29	22,5	19	7/16-20
			203311.3	8	5/16	1/4	29	22,5	19	1/2-20
			203312.3	10	3/8	1/8	27,5	17	14	9/16-18
			203313.3	10	3/8	3/8	31,5	26	22	9/16-18
			203314.3	12	1/2	1/4	32	22,5	19	3/4-16
			203315.3	12	1/2	1/2	36	31	27	3/4-16
	240	240	203316.3	18-20	3/4	1/2	42	31	27	1 1/16-12

Notes: If you wish to order a fitting in stainless steel, please change the first two digit from 20.... to 21....
Articles available on request only.

STRAIGHT INTERMEDIATE REDUCTION

Type: 2034...3

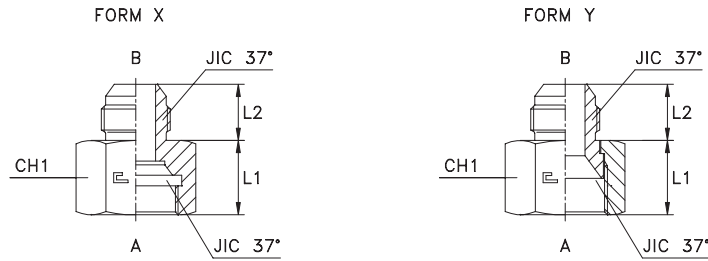

Series JIC	20.... [bar]	21.... [bar]	Ordering Complete	Ø Tube AM	Ø Tube BM	Ø Tube AW	Ø Tube BW	Form	L1	L2	CH1	JIC 37° A	JIC 37° B
UNIVERSAL	450	450	203401.3	8	6	5/16	1/4	X	17,6	13,9	17	1/2-20	7/16-20
	350	350	203402.3	10	6	3/8	1/4	Y	18,3	13,9	19	9/16-18	7/16-20
			203403.3	12	6	1/2	1/4	Y	21,3	13,9	22	3/4-16	7/16-20
			203404.3	14-15-16	6	5/8	1/4	Y	24,6	13,9	27	7/8-14	7/16-20
			203405.3	18-20	6	3/4	1/4	Y	25,9	13,9	32	1 1/16-12	7/16-20
	290	290	203406.3	25	6	1	1/4	Y	28,5	13,9	41	1 5/16-12	7/16-20
	240	240	203407.3	30-32	6	1 1/4	1/4	Y	31	13,9	50	1 5/8-12	7/16-20
			203408.3	38	6	1 1/2	1/4	Y	35,8	13,9	60	1 7/8-12	7/16-20
	350	350	203409.3	10	8	3/8	5/16	X	17,6	13,9	19	9/16-18	1/2-20
			203410.3	12	8	1/2	5/16	Y	21,3	13,9	22	3/4-16	1/2-20
			203411.3	14-15-16	8	5/8	5/16	Y	24,6	13,9	27	7/8-14	1/2-20
			203412.3	18-20	8	3/4	5/16	Y	25,9	13,9	32	1 1/16-12	1/2-20
	290	290	203413.3	25	8	1	5/16	Y	28,5	13,9	41	1 5/16-12	1/2-20
	240	240	203414.3	30-32	8	1 1/4	5/16	Y	31	13,9	50	1 5/8-12	1/2-20
			203415.3	38	8	1 1/2	5/16	Y	35,8	13,9	60	1 7/8-12	1/2-20
	350	350	203416.3	12	10	1/2	3/8	Y	21,3	14	22	3/4-16	9/16-18
			203417.3	14-15-16	10	5/8	3/8	Y	24,6	14	27	7/8-14	9/16-18
			203418.3	18-20	10	3/4	3/8	Y	25,9	14	32	1 1/16-12	9/16-18
	290	290	203419.3	25	10	1	3/8	Y	28,5	14	41	1 5/16-12	9/16-18
	240	240	203420.3	30-32	10	1 1/4	3/8	Y	31	14	50	1 5/8-12	9/16-18
			203421.3	38	10	1 1/2	3/8	Y	35,8	14	60	1 7/8-12	9/16-18
	350	350	203422.3	14-15-16	12	5/8	1/2	X	24,3	16,7	27	7/8-14	3/4-16
			203423.3	18-20	12	3/4	1/2	Y	25,9	16,7	32	1 1/16-12	3/4-16
	290	290	203424.3	25	12	1	1/2	Y	28,5	16,7	41	1 5/16-12	3/4-16
	240	240	203425.3	30-32	12	1 1/4	1/2	Y	31	16,7	50	1 5/8-12	3/4-16
			203426.3	38	12	1 1/2	1/2	Y	35,8	16,7	60	1 7/8-12	3/4-16
	350	350	203427.3	18-20	14-15-16	3/4	5/8	X	27,2	19,3	32	1 1/16-12	7/8-14
	290	290	203428.3	25	14-15-16	1	5/8	Y	28,5	19,3	41	1 5/16-12	7/8-14
	240	240	203429.3	30-32	14-15-16	1 1/4	5/8	Y	31	19,3	50	1 5/8-12	7/8-14
			203430.3	38	14-15-16	1 1/2	5/8	Y	35,8	19,3	60	1 7/8-12	7/8-14
	290	290	203431.3	25	18-20	1	3/4	Y	28,5	21,9	41	1 5/16-12	1 1/16-12
	240	240	203432.3	30-32	18-20	1 1/4	3/4	Y	31	21,9	50	1 5/8-12	1 1/16-12
203433.3			38	18-20	1 1/2	3/4	Y	35,8	21,9	60	1 7/8-12	1 1/16-12	
203434.3			30-32	25	1 1/4	1	Y	31	23,1	50	1 5/8-12	1 5/16-12	
203435.3			38	25	1 1/2	1	Y	35,8	23,1	60	1 7/8-12	1 5/16-12	
			203436.3	38	30-32	1 1/2	1 1/4	Y	35,8	24,3	60	1 7/8-12	1 5/8-12

Notes: If you wish to order a fitting in stainless steel, please change the first two digit from 20.... to 21....
 If you wish to order AISI 304 stainless steel fittings, please change the first two digits from 20.... to 44....

MALE STUD COUPLING WITH SWIVEL NUT AND ELASTOMER SEAL

Thread BSP Parallel - Thread Metric Parallel

Type: 2035..
Type: 2036..

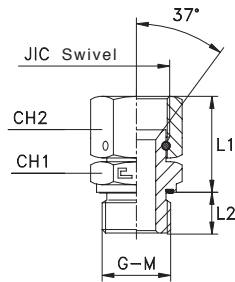

Series JIC	20.... [bar]	21.... [bar]	Ordering Complete	JIC 37°	G	L1	L2	CH1	CH2
UNIVERSAL	350	350	203501	7/16-20	1/8	26	8	14	14
			203502	1/2-20	1/8	27,5	8	14	17
			203503	9/16-18	1/4	27,8	12	19	19
			203504	3/4-16	3/8	32,1	12	22	22
			203505	7/8-14	1/2	37,6	14	27	27
			203506	1 1/16-12	3/4	39,2	16	32	32
	290	290	203507	1 5/16-12	1	44,4	18	41	41
			203508	1 5/8-12	1 1/4	47,3	20	50	50
	240	240	203509	1 7/8-12	1 1/2	54,8	22	55	60
			203510	7/16-20	1/4	25,5	12	19	14
	350	350	203511	7/16-20	3/8	27,5	12	22	14
			203512	1/2-20	1/4	27	12	19	17
			203513	1/2-20	3/8	29	12	22	17
			203514	9/16-18	3/8	29,8	12	22	19
			203515	9/16-18	1/2	31,3	14	27	19
			203516	3/4-16	1/4	30,1	12	19	22
			203517	3/4-16	1/2	33,6	14	27	22
			203518	7/8-14	3/8	36,1	12	22	27
			203519	7/8-14	3/4	39,1	16	32	27
			203520	1 1/16-12	1/2	37,7	14	27	32
	290	290	203521	1 1/16-12	1	40,7	18	41	32
			203522	1 5/16-12	3/4	42,9	16	32	41
	240	240	203523	1 5/16-12	1 1/4	46,9	20	50	41
			203524	1 5/8-12	1	44,8	18	41	50
			203525	1 7/8-12	1 1/4	54,3	20	50	60

Notes: If you wish to order a fitting in stainless steel, please change the first two digit from 20.... to 21.... .
Articles available on scheduled orders only.

Series JIC	20.... [bar]	21.... [bar]	Ordering Complete	JIC 37°	M	L1	L2	CH1	CH2
UNIVERSAL	350	350	203601	7/16-20	10x1	24,5	8	14	14
			203602	1/2-20	12x1,5	26	8	17	17
			203603	9/16-18	14x1,5	26,8	12	19	19
			203604	3/4-16	16x1,5	29,6	12	22	22
			203605	7/8-14	22x1,5	36,1	14	27	27
			203606	1 1/16-12	27x2	36,7	16	32	32
	290	290	203607	1 5/16-12	33x2	41,4	18	41	41
	240	240	203608	1 5/8-12	42x2	43,8	20	50	50
			203609	1 7/8-12	48x2	51,3	22	55	60
	350	350	203610	7/16-20	12x1,5	24,5	8	17	14
			203611	1/2-20	10x1	26	8	14	17
			203612	1/2-20	14x1,5	26	12	19	17
			203613	9/16-18	16x1,5	27,3	12	22	19
			203614	3/4-16	18x1,5	30,6	12	24	22
			203615	7/8-14	18x1,5	34,6	12	24	27
			203616	7/8-14	20x1,5	35,6	14	27	27
			203617	1 1/16-12	22x1,5	36,2	14	27	32
	290	290	203618	1 5/16-12	27x2	40,4	16	32	41

Notes: If you wish to order a fitting in stainless steel, please change the first two digit from 20.... to 21.... .
Articles available on scheduled orders only.

MALE STUD COUPLING WITH SWIVEL NUT AND O-RING

Thread UNF/UN-2A

Type: 2037..

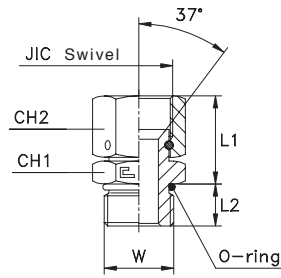

Series JIC	20.... [bar]	21.... [bar]	Ordering Complete	JIC 37°	W	L1	L2	CH1	CH2
UNIVERSAL	350	350	203701	7/16-20	7/16-20	25,4	9,1	14	14
			203702	1/2-20	1/2-20	26,9	9,1	17	17
			203703	9/16-18	9/16-18	28,8	10	17	19
			203704	3/4-16	3/4-16	32	11,1	22	22
			203705	7/8-14	7/8-14	37,4	12,7	27	27
	203706	1 1/16-12	1 1/16-12	39,1	15,1	32	32		
	290	290	203707	1 5/16-12	1 5/16-12	43,3	15,1	41	41
	240	240	203708	1 5/8-12	1 5/8-12	45,7	15,1	50	50
			203709	1 7/8-12	1 7/8-12	54,7	15,1	55	60
	350	350	203710	7/16-20	1/2-20	25,4	9,1	17	14
			203711	7/16-20	9/16-18	26,5	10	17	14
			203712	9/16-18	3/4-16	29,7	11,1	22	19
			203713	3/4-16	7/8-14	33,4	12,7	27	22
			203714	3/4-16	1 1/16-12	35	15,1	32	22
			203715	7/8-14	3/4-16	36	11,1	22	27
			203716	7/8-14	1 1/16-12	39	15,1	32	27
			203717	1 1/16-12	3/4-16	37,6	11,1	27	32
			203718	1 1/16-12	7/8-14	37,5	12,7	27	32
	290	290	203719	1 1/16-12	1 5/16-12	39,6	15,1	41	32
			203720	1 5/16-12	1 1/16-12	42,8	15,1	32	41
	240	240	203721	1 5/16-12	1 5/8-12	45,3	15,1	50	41

Notes: If you wish to order a fitting in stainless steel, please change the first two digit from 20.... to 21.... .
Articles available on scheduled orders only.

MALE STUD COUPLING WITH SWIVEL NUT

Thread BSP Taper - Thread NPTF

Type: 2038..

Type: 2039..

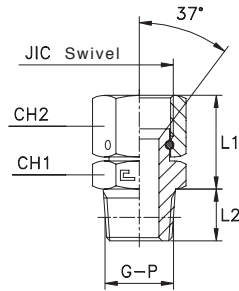

Series JIC	20.... [bar]	21.... [bar]	Ordering Complete	JIC 37°	G	L1	L2	CH1	CH2
UNIVERSAL	350	350	203801	7/16-20	1/8	24,5	10	12	14
			203802	1/2-20	1/8	26	10	12	17
			203803	9/16-18	1/4	26,8	14,5	14	19
			203804	3/4-16	3/8	30,1	14,5	19	22
			203805	7/8-14	1/2	34,1	19	22	27
			203806	1 1/16-12	3/4	37,2	19	27	32
	290	290	203807	1 5/16-12	1	41,4	24	36	41
	240	240	203808	1 5/8-12	1 1/4	42,8	25	46	50
			203809	1 7/8-12	1 1/2	51,8	26	50	60
	350	350	203810	7/16-20	1/4	24,5	14,5	14	14
			203811	1/2-20	1/4	26	14,5	14	17
			203812	9/16-18	3/8	27,8	14,5	17	19
			203813	3/4-16	1/4	30,1	14,5	17	22
			203814	3/4-16	1/2	30,1	19	22	22
			203815	7/8-14	3/8	34,1	14,5	22	27
			203816	7/8-14	3/4	37,1	19	27	27
			203817	1 1/16-12	1/2	37,2	19	27	32
	290	290	203818	1 1/16-12	1	37,7	24	36	32
			203819	1 5/16-12	3/4	40,9	19	32	41

Notes: If you wish to order a fitting in stainless steel, please change the first two digit from 20.... to 21.... .
Articles available on scheduled orders only.

Series JIC	20.... [bar]	21.... [bar]	Ordering Complete	JIC 37°	P	L1	L2	CH1	CH2
UNIVERSAL	350	350	203901	7/16-20	1/8	24,5	10	12	14
			203902	1/2-20	1/8	26	10	12	17
			203903	9/16-18	1/4	26,8	14,5	14	19
			203904	3/4-16	3/8	30,1	14,5	19	22
			203905	7/8-14	1/2	34,1	19	22	27
			203906	1 1/16-12	3/4	37,2	19	27	32
	290	290	203907	1 5/16-12	1	41,4	24	36	41
	240	240	203908	1 5/8-12	1 1/4	42,8	25	46	50
			203909	1 7/8-12	1 1/2	51,8	26	50	60
	350	350	203910	7/16-20	1/4	24,5	14,5	14	14
			203911	1/2-20	1/4	26	14,5	14	17
			203912	9/16-18	1/8	26,8	10	14	19
			203913	9/16-18	3/8	27,8	14,5	17	19
			203914	9/16-18	1/2	27,8	19	22	19
			203915	3/4-16	1/4	30,1	14,5	19	22
			203916	3/4-16	1/2	30,1	19	22	22
			203917	3/4-16	3/4	33,1	19	27	22
			203918	7/8-14	3/8	34,1	14,5	22	27
			203919	7/8-14	3/4	37,1	19	27	27
	203920	1 1/16-12	1/2	37,2	19	27	32		
	290	290	203921	1 5/16-12	3/4	40,9	19	32	41
	240	240	203922	1 5/8-12	1	42,3	24	41	50

Notes: If you wish to order a fitting in stainless steel, please change the first two digit from 20.... to 21.... .
Articles available on scheduled orders only.

ADJUSTABLE ELBOW WITH SWIVEL NUT

Thread UNF/UN-2B

Type: 2040...3

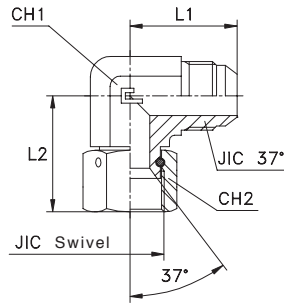

Series JIC	20.... [bar]	21.... [bar]	Ordering Complete	Ø Tube M	Ø Tube W	JIC 37°	L1	L2	CH1	CH2
UNIVERSAL	450	450	204001.3	6	1/4	7/16-20	23	26,5	11	14
			204002.3	8	5/16	1/2-20	24	27	14	17
	350	350	204003.3	10	3/8	9/16-18	27,5	31,3	14	19
			204004.3	12	1/2	3/4-16	32	35,6	19	22
			204005.3	14-15-16	5/8	7/8-14	37	41,6	22	27
			204006.3	18-20	3/4	1 1/16-12	42	44,2	27	32
	290	290	204007.3	25	1	1 5/16-12	46	51,4	33	41
	240	240	204008.3	30-32	1 1/4	1 5/8-12	53	58,8	41	50
			204009.3	38	1 1/2	1 7/8-12	59	66,3	48	60

Notes: If you wish to order a fitting in stainless steel, please change the first two digit from 20.... to 21.... .
Articles available on scheduled orders only.

ADJUSTABLE 45° ELBOW WITH SWIVEL NUT

Thread UNF/UN-2B

Type: 2041...3

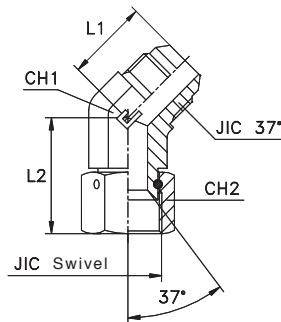

Series JIC	20.... [bar]	21.... [bar]	Ordering Complete	Ø Tube M	Ø Tube W	JIC 37°	L1	L2	CH1	CH2
UNIVERSAL	450	450	204101.3	6	1/4	7/16-20	19,5	24,5	11	14
			204102.3	8	5/16	1/2-20	20	25,5	14	17
	350	350	204103.3	10	3/8	9/16-18	21,5	27,3	14	19
			204104.3	12	1/2	3/4-16	25,5	33,1	19	22
			204105.3	14-15-16	5/8	7/8-14	29	36,6	22	27
			204106.3	18-20	3/4	1 1/16-12	33	37,2	27	32
	290	290	204107.3	25	1	1 5/16-12	38	45,4	33	41
	240	240	204108.3	30-32	1 1/4	1 5/8-12	40	51,3	41	50
			204109.3	38	1 1/2	1 7/8-12	46	57,8	48	60

Notes: If you wish to order a fitting in stainless steel, please change the first two digit from 20.... to 21.... .
Articles available on scheduled orders only.

ADJUSTABLE BARREL TEE WITH SWIVEL NUT

Thread UNF/UN-2B

Type: **2042...3**

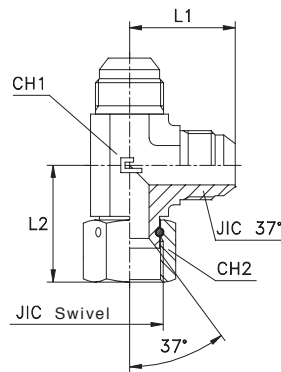

Series JIC	20.... [bar]	21.... [bar]	Ordering Complete	Ø Tube M	Ø Tube W	JIC 37°	L1	L2	CH1	CH2
UNIVERSAL	450	450	204201.3	6	1/4	7/16-20	23	26,5	11	14
			204202.3	8	5/16	1/2-20	24	27	14	17
	350	350	204203.3	10	3/8	9/16-18	27,5	31,3	14	19
			204204.3	12	1/2	3/4-16	32	35,6	19	22
			204205.3	14-15-16	5/8	7/8-14	37	41,6	22	27
			204206.3	18-20	3/4	1 1/16-12	42	44,2	27	32
	290	290	204207.3	25	1	1 5/16-12	46	51,4	33	41
	240	240	204208.3	30-32	1 1/4	1 5/8-12	53	58,8	41	50
			204209.3	38	1 1/2	1 7/8-12	59	66,3	48	60

Notes: If you wish to order a fitting in stainless steel, please change the first two digit from **20....** to **21....** .
Articles available on scheduled orders only.

ADJUSTABLE BRANCH TEE WITH SWIVEL NUT

Thread UNF/UN-2B

Type: **2043...3**

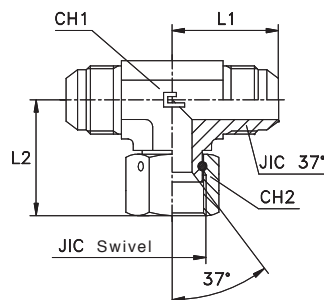

Series JIC	20.... [bar]	21.... [bar]	Ordering Complete	Ø Tube M	Ø Tube W	JIC 37°	L1	L2	CH1	CH2
UNIVERSAL	450	450	204301.3	6	1/4	7/16-20	23	26,5	11	14
			204302.3	8	5/16	1/2-20	24	27	14	17
	350	350	204303.3	10	3/8	9/16-18	27,5	31,3	14	19
			204304.3	12	1/2	3/4-16	32	35,6	19	22
			204305.3	14-15-16	5/8	7/8-14	37	41,6	22	27
			204306.3	18-20	3/4	1 1/16-12	42	44,2	27	32
	290	290	204307.3	25	1	1 5/16-12	46	51,4	33	41
	240	240	204308.3	30-32	1 1/4	1 5/8-12	53	58,8	41	50
			204309.3	38	1 1/2	1 7/8-12	59	66,3	48	60

Notes: If you wish to order a fitting in stainless steel, please change the first two digit from **20....** to **21....** .
Articles available on scheduled orders only.

ADJUSTABLE MALE STUD ELBOW WITH O-RING AND WASHER

Thread BSP Parallel - Thread Metric Parallel

Type: 2044...3
Type: 2045...3

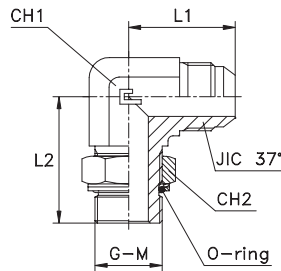

Series JIC	20.... [bar]	21.... [bar]	Ordering Complete	Ø Tube M	Ø Tube W	G	L1	L2	CH1	CH2	JIC 37°
UNIVERSAL	350	350	204401.3	6	1/4	1/8	23	26	11	14	7/16-20
	315	315	204402.3	8	5/16	1/4	24	32	14	19	1/2-20
			204403.3	10	3/8	1/4	27,5	32	14	19	9/16-18
	250	250	204404.3	12	1/2	3/8	32	37	19	22	3/4-16
			204405.3	14-15-16	5/8	1/2	37	43	22	27	7/8-14
			204406.3	18-20	3/4	3/4	42	49	27	36	1 1/16-12
	200	200	204407.3	25	1	1	46	52	33	41	15/16-12
			204408.3	30-32	1 1/4	1 1/4	53	58	41	50	15/8-12
	160	160	204409.3	38	1 1/2	1 1/2	59	60	48	55	17/8-12
	315	315	204410.3	6	1/4	1/4	24	32	14	19	7/16-20
	250	250	204411.3	6	1/4	3/8	29	37	19	22	7/16-20
			204412.3	6	1/4	1/2	31	43	22	27	7/16-20
			204413.3	8	5/16	1/8	24	30	14	14	1/2-20
	250	250	204414.3	8	5/16	3/8	29	37	19	22	1/2-20
			204415.3	10	3/8	3/8	29,5	37	19	22	9/16-18
			204416.3	10	3/8	1/2	31,5	43	22	27	9/16-18
	315	315	204417.3	12	1/2	1/4	32	37	19	19	3/4-16
			204418.3	12	1/2	1/2	34	43	22	27	3/4-16
			204419.3	12	1/2	3/4	36	49	27	36	3/4-16
			204420.3	14-15-16	5/8	3/8	37	37,5	22	22	7/8-14
			204421.3	14-15-16	5/8	3/4	39	49	27	36	7/8-14
	200	200	204422.3	18-20	3/4	1/2	42	47	27	27	1 1/16-12
	200	200	204423.3	18-20	3/4	1	45	52	33	41	1 1/16-12
	250	250	204424.3	25	1	3/4	46	50	33	36	15/16-12
204425.3			25	1	1 1/4	52	58	41	50	15/16-12	
204426.3			30-32	1 1/4	1	53	58	41	41	15/8-12	
204427.3			38	1 1/2	1 1/4	59	60	48	50	17/8-12	

Notes: If you wish to order a fitting in stainless steel, please change the first two digit from 20.... to 21....

Series JIC	20.... [bar]	21.... [bar]	Ordering Complete	Ø Tube M	Ø Tube W	M	L1	L2	CH1	CH2	JIC 37°
UNIVERSAL	350	350	204501.3	6	1/4	10x1	23	27	11	14	7/16-20
	315	315	204502.3	8	5/16	12x1,5	24	31	14	17	1/2-20
			204503.3	10	3/8	14x1,5	27,5	33	14	19	9/16-18
			204504.3	12	1/2	16x1,5	32	38	19	22	3/4-16
	250	250	204505.3	14-15-16	5/8	22x1,5	37	42	22	27	7/8-14
			204506.3	18-20	3/4	27x2	42	50,5	27	32	1 1/16-12
	200	200	204507.3	25	1	33x2	46	52,5	33	41	15/16-12
			204508.3	30-32	1 1/4	42x2	53	58	41	50	15/8-12
	160	160	204509.3	38	1 1/2	48x2	59	63	48	55	17/8-12
	315	315	204510.3	6	1/4	12x1,5	24	31	14	17	7/16-20
	350	350	204511.3	8	5/16	10x1	24	28	14	14	1/2-20
			204512.3	8	5/16	14x1,5	24	33	14	19	1/2-20
			204513.3	10	3/8	16x1,5	29,5	38	19	22	9/16-18
			204514.3	12	1/2	18x1,5	32	38	19	24	3/4-16
			204515.3	14-15-16	5/8	18x1,5	37	40	22	24	7/8-14
	250	250	204516.3	14-15-16	5/8	20x1,5	37	42	22	27	7/8-14
			204517.3	18-20	3/4	22x1,5	42	46	27	27	1 1/16-12
			204518.3	25	1	27x2	46	52,5	33	32	15/16-12

Notes: If you wish to order a fitting in stainless steel, please change the first two digit from 20.... to 21....
Articles available on scheduled orders only.

ADJUSTABLE MALE STUD ELBOW WITH O-RING

Thread UNF/UN-2A

Type: **2046...3**

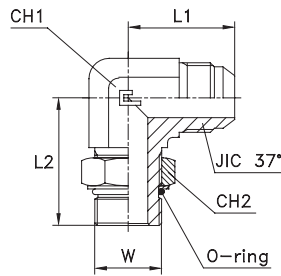

Series JIC	20.... [bar]	21.... [bar]	Ordering Complete	Ø Tube M	Ø Tube W	W	L1	L2	CH1	CH2	JIC 37°
UNIVERSAL	400	400	204601.3	6	1/4	7/16-20	23	27	11	14	7/16-20
			204602.3	8	5/16	1/2-20	24	29	14	17	1/2-20
	350	350	204603.3	10	3/8	9/16-18	27,5	32	14	17	9/16-18
			204604.3	12	1/2	3/4-16	32	37	19	22	3/4-16
			204605.3	14-15-16	5/8	7/8-14	37	43	22	27	7/8-14
	290	290	204606.3	18-20	3/4	1 1/16-12	42	49,5	27	32	1 1/16-12
			204607.3	25	1	1 5/16-12	46	52	33	41	1 5/16-12
	240	240	204608.3	30-32	1 1/4	1 5/8-12	53	58	41	50	1 5/8-12
			204609.3	38	1 1/2	1 7/8-12	59	60	48	55	1 7/8-12
	400	400	204610.3	6	1/4	1/2-20	24	29	14	17	7/16-20
			204611.3	6	1/4	9/16-18	24	32	14	17	7/16-20
	350	350	204612.3	8	5/16	9/16-18	24	32	14	17	1/2-20
			204613.3	10	3/8	7/16-20	27,5	28	14	14	9/16-18
			204614.3	10	3/8	1/2-20	27,5	29	14	17	9/16-18
			204615.3	10	3/8	3/4-16	29,5	37	19	22	9/16-18
			204616.3	10	3/8	7/8-14	31,5	43	22	27	9/16-18
			204617.3	12	1/2	9/16-18	32	36,5	19	17	3/4-16
			204618.3	12	1/2	7/8-14	34	43	22	27	3/4-16
			204619.3	12	1/2	1 1/16-12	36	49,5	27	32	3/4-16
			204620.3	14-15-16	5/8	3/4-16	37	39,5	22	22	7/8-14
			204621.3	14-15-16	5/8	1 1/16-12	39	49,5	27	32	7/8-14
			204622.3	18-20	3/4	3/4-16	42	41,5	27	22	1 1/16-12
			204623.3	18-20	3/4	7/8-14	42	47	27	27	1 1/16-12
	290	290	204624.3	18-20	3/4	1 5/16-12	45	52	33	41	1 1/16-12
			204625.3	25	1	1 1/16-12	46	51,5	33	32	1 5/16-12
	240	240	204626.3	25	1	1 5/8-12	52	58	41	50	1 5/16-12

Notes: If you wish to order a fitting in stainless steel, please change the first two digit from 20.... to 21.... .
Articles available on scheduled orders only.

45° ADJUSTABLE MALE STUD ELBOW WITH O-RING AND WASHER

Thread BSP Parallel - Thread Metric Parallel

Type: 2047...3

Type: 2048...3

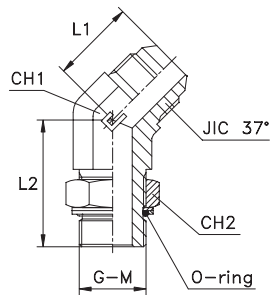

Series JIC	20.... [bar]	21.... [bar]	Ordering Complete	Ø Tube M	Ø Tube W	G	L1	L2	CH1	CH2	JIC 37°
UNIVERSAL	350	350	204701.3	6	1/4	1/8	19,5	26	11	14	7/16-20
	315	315	204702.3	8	5/16	1/4	20	29	14	19	1/2-20
			204703.3	10	3/8	1/4	21,5	29	14	19	9/16-18
	250	250	204704.3	12	1/2	3/8	25,5	33	19	22	3/4-16
			204705.3	14-15-16	5/8	1/2	29	38,5	22	27	7/8-14
			204706.3	18-20	3/4	3/4	33	44	27	36	1 1/16-12
	200	200	204707.3	25	1	1	38	47	33	41	15/16-12
			204708.3	30-32	1 1/4	1 1/4	40	48	41	50	15/8-12
	160	160	204709.3	38	1 1/2	1 1/2	46	48	48	55	17/8-12
	315	315	204710.3	6	1/4	1/4	20	29	14	19	7/16-20
	250	250	204711.3	6	1/4	3/8	22,5	33	19	22	7/16-20
			204712.3	6	1/4	1/2	23	38,5	22	27	7/16-20
	350	350	204713.3	8	5/16	1/8	20	24	14	14	1/2-20
			204714.3	8	5/16	3/8	22,5	33	19	22	1/2-20
	250	250	204715.3	10	3/8	3/8	23	33	19	22	9/16-18
			204716.3	10	3/8	1/2	23,5	38,5	22	27	9/16-18
			204717.3	12	1/2	1/4	25,5	32,5	19	19	3/4-16
	250	250	204718.3	12	1/2	1/2	26	38,5	22	27	3/4-16
			204719.3	12	1/2	3/4	27	44	27	36	3/4-16
			204720.3	14-15-16	5/8	3/8	29	33	22	22	7/8-14
			204721.3	14-15-16	5/8	3/4	30	44	27	36	7/8-14
	200	200	204722.3	18-20	3/4	1/2	33	43	27	27	11/16-12
			204723.3	18-20	3/4	1	37	47	33	41	11/16-12
	250	250	204724.3	25	1	3/4	38	45	33	36	15/16-12
			204725.3	25	1	1 1/4	39	48	41	50	15/16-12
	200	200	204726.3	30-32	1 1/4	1	40	48	41	41	15/8-12
			204727.3	38	1 1/2	1 1/4	46	48	48	50	17/8-12

Notes: If you wish to order a fitting in stainless steel, please change the first two digit from 20.... to 21....
Articles available on scheduled orders only.

Series JIC	20.... [bar]	21.... [bar]	Ordering Complete	Ø Tube M	Ø Tube W	M	L1	L2	CH1	CH2	JIC 37°
UNIVERSAL	350	350	204801.3	6	1/4	10x1	19,5	27	11	14	7/16-20
	315	315	204802.3	8	5/16	12x1,5	20	27	14	17	1/2-20
			204803.3	10	3/8	14x1,5	21,5	28	14	19	9/16-18
			204804.3	12	1/2	16x1,5	25,5	33	19	22	3/4-16
	250	250	204805.3	14-15-16	5/8	22x1,5	29	38	22	27	7/8-14
			204806.3	18-20	3/4	27x2	33	46	27	32	1 1/16-12
	200	200	204807.3	25	1	33x2	38	46	33	41	15/16-12
			204808.3	30-32	1 1/4	42x2	40	48	41	50	15/8-12
	160	160	204809.3	38	1 1/2	48x2	46	50	48	55	17/8-12
	315	315	204810.3	6	1/4	12x1,5	20	27	14	17	7/16-20
	350	350	204811.3	8	5/16	10x1	20	24	14	14	1/2-20
			204812.3	8	5/16	14x1,5	20	28	14	19	1/2-20
	315	315	204813.3	10	3/8	16x1,5	23	33	19	22	9/16-18
			204814.3	12	1/2	18x1,5	25,5	33	19	24	3/4-16
			204815.3	14-15-16	5/8	18x1,5	29	34,5	22	24	7/8-14
	250	250	204816.3	14-15-16	5/8	20x1,5	29	38	22	27	7/8-14
			204817.3	18-20	3/4	22x1,5	33	41,5	27	27	11/16-12
	204818.3	25	1	27x2	38	46	33	32	15/16-12		

Notes: If you wish to order a fitting in stainless steel, please change the first two digit from 20.... to 21....
Articles available on scheduled orders only.

45° ADJUSTABLE MALE STUD ELBOW WITH O-RING

Thread UNF/UN-2A

Type: 2049...3

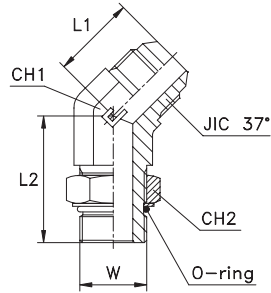

Series JIC	20... [bar]	21... [bar]	Ordering Complete	Ø Tube M	Ø Tube W	W	L1	L2	CH1	CH2	JIC 37°
UNIVERSAL	400	400	204901.3	6	1/4	7/16-20	19,5	26,5	11	14	7/16-20
			204902.3	8	5/16	1/2-20	20	26,5	14	17	1/2-20
	350	350	204903.3	10	3/8	9/16-18	21,5	29	14	17	9/16-18
			204904.3	12	1/2	3/4-16	25,5	33	19	22	3/4-16
			204905.3	14-15-16	5/8	7/8-14	29	39	22	27	7/8-14
	290	290	204906.3	18-20	3/4	1 1/16-12	33	44	27	32	1 1/16-12
			204907.3	25	1	1 5/16-12	38	47	33	41	1 5/16-12
	240	240	204908.3	30-32	1 1/4	1 5/8-12	40	48	41	50	1 5/8-12
			204909.3	38	1 1/2	1 7/8-12	46	48,5	48	55	1 7/8-12
	400	400	204910.3	6	1/4	1/2-20	20	26,5	14	17	7/16-20
			204911.3	10	3/8	3/4-16	23	33	19	22	9/16-18
	350	350	204912.3	12	1/2	7/8-14	26	39	22	27	3/4-16
			204913.3	14-15-16	5/8	3/4-16	29	35,5	22	22	7/8-14
			204914.3	18-20	3/4	3/4-16	33	36	27	22	1 1/16-12
			204915.3	18-20	3/4	7/8-14	33	39	27	27	1 1/16-12
	290	290	204916.3	18-20	3/4	1 5/16-12	37	47	33	41	1 1/16-12
			204917.3	25	1	1 1/16-12	38	46,5	33	32	1 5/16-12
	240	240	204918.3	25	1	1 5/8-12	39	48	41	50	1 5/16-12

Notes: If you wish to order a fitting in stainless steel, please change the first two digit from 20.... to 21....
Articles available on scheduled orders only.

ADJUSTABLE MALE STUD BARREL TEE WITH O-RING AND WASHER

Thread BSP Parallel - Thread Metric Parallel

Type: 2050...3

Type: 2051...3

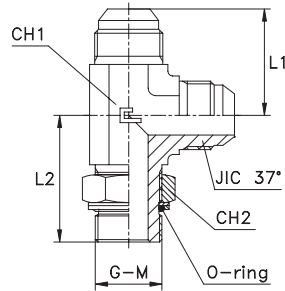

Series JIC	20.... [bar]	21.... [bar]	Ordering Complete	Ø Tube M	Ø Tube W	G	L1	L2	CH1	CH2	JIC 37°
UNIVERSAL	350	350	205001.3	6	1/4	1/8	23	26	11	14	7/16-20
	315	315	205002.3	8	5/16	1/4	24	32	14	19	1/2-20
			205003.3	10	3/8	1/4	27,5	32	14	19	9/16-18
	250	250	205004.3	12	1/2	3/8	32	37	19	22	3/4-16
			205005.3	14-15-16	5/8	1/2	37	43	22	27	7/8-14
			205006.3	18-20	3/4	3/4	42	49	27	36	1 1/16-12
	200	200	205007.3	25	1	1	46	52	33	41	1 5/8-12
			205008.3	30-32	1 1/4	1 1/4	53	58	41	50	1 5/8-12
	160	160	205009.3	38	1 1/2	1 1/2	59	60	48	55	1 7/8-12
	315	315	205010.3	6	1/4	1/4	24	32	14	19	7/16-20
	250	250	205011.3	6	1/4	3/8	29	37	19	22	7/16-20
			205012.3	6	1/4	1/2	31	43	22	27	7/16-20
	350	350	205013.3	8	5/16	1/8	24	30	14	14	1/2-20
			205014.3	8	5/16	3/8	29	37	19	22	1/2-20
			205015.3	10	3/8	3/8	29,5	37	19	22	9/16-18
	250	250	205016.3	10	3/8	1/2	31,5	43	22	27	9/16-18
			205017.3	12	1/2	1/4	32	37	19	19	3/4-16
	250	250	205018.3	12	1/2	1/2	34	43	22	27	3/4-16
			205019.3	12	1/2	3/4	36	49	27	36	3/4-16
			205020.3	14-15-16	5/8	3/8	37	37,5	22	22	7/8-14
			205021.3	14-15-16	5/8	3/4	39	49	27	36	7/8-14
			205022.3	18-20	3/4	1/2	42	47	27	27	1 1/16-12
	200	200	205023.3	18-20	3/4	1	45	52	33	41	1 1/16-12
	250	250	205024.3	25	1	3/4	46	50	33	36	1 5/16-12
			205025.3	25	1	1 1/4	52	58	41	50	1 5/16-12
			205026.3	30-32	1 1/4	1	53	58	41	41	1 5/8-12
			205027.3	38	1 1/2	1 1/4	59	60	48	50	1 7/8-12

Notes: If you wish to order a fitting in stainless steel, please change the first two digit from 20.... to 21....

Series JIC	20.... [bar]	21.... [bar]	Ordering Complete	Ø Tube M	Ø Tube W	M	L1	L2	CH1	CH2	JIC 37°
UNIVERSAL	350	350	205101.3	6	1/4	10x1	23	27	11	14	7/16-20
	315	315	205102.3	8	5/16	12x1,5	24	31	14	17	1/2-20
			205103.3	10	3/8	14x1,5	27,5	33	14	19	9/16-18
			205104.3	12	1/2	16x1,5	32	38	19	22	3/4-16
	250	250	205105.3	14-15-16	5/8	22x1,5	37	42	22	27	7/8-14
			205106.3	18-20	3/4	27x2	42	50,5	27	32	1 1/16-12
	200	200	205107.3	25	1	33x2	46	52,5	33	41	1 5/16-12
			205108.3	30-32	1 1/4	42x2	53	58	41	50	1 5/8-12
	160	160	205109.3	38	1 1/2	48x2	59	63	48	55	1 7/8-12
	315	315	205110.3	6	1/4	12x1,5	24	31	14	17	7/16-20
	350	350	205111.3	8	5/16	10x1	24	28	14	14	1/2-20
			205112.3	8	5/16	14x1,5	24	33	14	19	1/2-20
	315	315	205113.3	10	3/8	16x1,5	29,5	38	19	22	9/16-18
			205114.3	12	1/2	18x1,5	32	38	19	24	3/4-16
			205115.3	14-15-16	5/8	18x1,5	37	40	22	24	7/8-14
	250	250	205116.3	14-15-16	5/8	20x1,5	37	42	22	27	7/8-14
			205117.3	18-20	3/4	22x1,5	42	46	27	27	1 1/16-12
			205118.3	25	1	27x2	46	52,5	33	32	1 5/16-12

Notes: If you wish to order a fitting in stainless steel, please change the first two digit from 20.... to 21....
Articles available on scheduled orders only.

ADJUSTABLE MALE STUD BARREL TEE WITH O-RING

Thread UNF/UN-2A

Type: **2052...3**

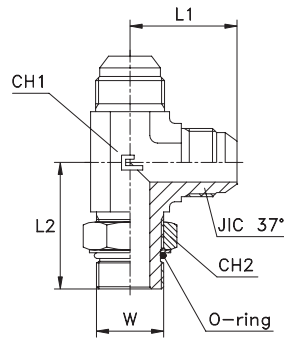

Series JIC	20.... [bar]	21.... [bar]	Ordering Complete	Ø Tube M	Ø Tube W	W	L1	L2	CH1	CH2	JIC 37°
UNIVERSAL	400	400	205201.3	6	1/4	7/16-20	23	27	11	14	7/16-20
			205202.3	8	5/16	1/2-20	24	29	14	17	1/2-20
	350	350	205203.3	10	3/8	9/16-18	27,5	32	14	17	9/16-18
			205204.3	12	1/2	3/4-16	32	37	19	22	3/4-16
			205205.3	14-15-16	5/8	7/8-14	37	43	22	27	7/8-14
			205206.3	18-20	3/4	1 1/16-12	42	49,5	27	32	1 1/16-12
	290	290	205207.3	25	1	1 5/16-12	46	52	33	41	1 5/16-12
	240	240	205208.3	30-32	1 1/4	1 5/8-12	53	58	41	50	1 5/8-12
			205209.3	38	1 1/2	1 7/8-12	59	60	48	55	1 7/8-12
	350	350	205210.3	6	1/4	1/2-20	24	29	14	17	7/16-20
			205211.3	6	1/4	9/16-18	24	32	14	17	7/16-20
			205212.3	10	3/8	3/4-16	29,5	37	19	22	9/16-18
			205213.3	12	1/2	7/8-14	34	43	22	27	3/4-16
			205214.3	12	1/2	1 1/16-12	36	49,5	27	32	3/4-16
			205215.3	14-15-16	5/8	3/4-16	37	39,5	22	22	7/8-14
			205216.3	14-15-16	5/8	1 1/16-12	39	49,5	27	32	7/8-14
			205217.3	18-20	3/4	3/4-16	42	41,5	27	22	1 1/16-12
			205218.3	18-20	3/4	7/8-14	42	47	27	27	1 1/16-12
			205219.3	18-20	3/4	1 5/16-12	45	52	33	41	1 1/16-12
			205220.3	25	1	1 1/16-12	46	49,5	33	32	1 5/16-12
			205221.3	25	1	1 5/8-12	52	58	41	50	1 5/16-12

Notes: If you wish to order a fitting in stainless steel, please change the first two digit from **20....** to **21....** .
Articles available on scheduled orders only.

ADJUSTABLE MALE STUD BRANCH TEE WITH O-RING AND WASHER

Thread BSP Parallel - Thread Metric Parallel

Type: 2053...3
Type: 2054...3

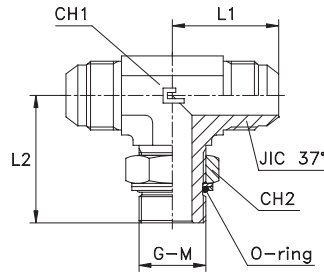

Series JIC	20.... [bar]	21.... [bar]	Ordering Complete	Ø Tube M	Ø Tube W	G	L1	L2	CH1	CH2	JIC 37°	
UNIVERSAL	350	350	205301.3	6	1/4	1/8	23	26	11	14	7/16-20	
	315	315	205302.3	8	5/16	1/4	24	32	14	19	1/2-20	
			205303.3	10	3/8	1/4	27,5	32	14	19	9/16-18	
	250	250	205304.3	12	1/2	3/8	32	37	37	19	22	3/4-16
			205305.3	14-15-16	5/8	1/2	37	43	22	27	7/8-14	
			205306.3	18-20	3/4	3/4	42	49	27	36	11/16-12	
	200	200	205307.3	25	1	1	46	52	33	41	15/16-12	
			205308.3	30-32	1 1/4	1 1/4	53	58	41	50	15/8-12	
	160	160	205309.3	38	1 1/2	1 1/2	59	60	48	55	17/8-12	
	315	315	205310.3	6	1/4	1/4	24	32	14	19	7/16-20	
	250	250	205311.3	6	1/4	3/8	29	37	19	22	7/16-20	
			205312.3	6	1/4	1/2	31	43	22	27	7/16-20	
	350	350	205313.3	8	5/16	1/8	24	30	14	14	1/2-20	
			205314.3	8	5/16	3/8	29	37	19	22	1/2-20	
	250	250	205315.3	10	3/8	3/8	29,5	37	19	22	9/16-18	
			205316.3	10	3/8	1/2	31,5	43	22	27	9/16-18	
			205317.3	12	1/2	1/4	32	37	19	19	3/4-16	
	250	250	205318.3	12	1/2	1/2	34	43	22	27	3/4-16	
			205319.3	12	1/2	3/4	36	49	27	36	3/4-16	
			205320.3	14-15-16	5/8	3/8	37	37,5	22	22	7/8-14	
			205321.3	14-15-16	5/8	3/4	39	49	27	36	7/8-14	
			205322.3	18-20	3/4	1/2	42	47	27	27	11/16-12	
	200	200	205323.3	18-20	3/4	1	45	52	33	41	11/16-12	
	250	250	205324.3	25	1	3/4	46	50	33	36	15/16-12	
	200	200	205325.3	25	1	1 1/4	52	58	41	50	15/16-12	
			205326.3	30-32	1 1/4	1	53	58	41	41	15/8-12	
			205327.3	38	1 1/2	1 1/4	59	60	48	50	17/8-12	

Notes: If you wish to order a fitting in stainless steel, please change the first two digit from 20.... to 21....

Series JIC	20.... [bar]	21.... [bar]	Ordering Complete	Ø Tube M	Ø Tube W	M	L1	L2	CH1	CH2	JIC 37°
UNIVERSAL	350	350	205401.3	6	1/4	10x1	23	27	11	14	7/16-20
	315	315	205402.3	8	5/16	12x1,5	24	31	14	17	1/2-20
			205403.3	10	3/8	14x1,5	27,5	33	14	19	9/16-18
			205404.3	12	1/2	16x1,5	32	38	19	22	3/4-16
	250	250	205405.3	14-15-16	5/8	22x1,5	37	42	22	27	7/8-14
			205406.3	18-20	3/4	27x2	42	50,5	27	32	11/16-12
	200	200	205407.3	25	1	33x2	46	52,5	33	41	15/16-12
			205408.3	30-32	1 1/4	42x2	53	58	41	50	15/8-12
	160	160	205409.3	38	1 1/2	48x2	59	63	48	55	17/8-12
	315	315	205410.3	6	1/4	12x1,5	24	31	14	17	7/16-20
	350	350	205411.3	8	5/16	10x1	24	28	14	14	1/2-20
	315	315	205412.3	8	5/16	14x1,5	24	33	14	19	1/2-20
			205413.3	10	3/8	16x1,5	29,5	38	19	22	9/16-18
			205414.3	12	1/2	18x1,5	32	38	19	24	3/4-16
			205415.3	14-15-16	5/8	18x1,5	37	40	22	24	7/8-14
	250	250	205416.3	14-15-16	5/8	20x1,5	37	42	22	27	7/8-14
			205417.3	18-20	3/4	22x1,5	42	46	27	27	11/16-12
			205418.3	25	1	27x2	46	52,5	33	32	15/16-12

Notes: If you wish to order a fitting in stainless steel, please change the first two digit from 20.... to 21....
Articles available on scheduled orders only.

ADJUSTABLE MALE STUD BARREL TEE WITH O-RING

Thread UNF/UN-2A

Type: **2055...3**

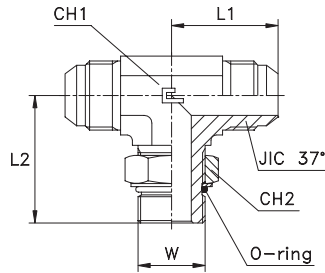

Series JIC	20.... [bar]	21.... [bar]	Ordering Complete	Ø Tube M	Ø Tube W	W	L1	L2	CH1	CH2	JIC 37°
UNIVERSAL	400	400	205501.3	6	1/4	7/16-20	23	27	11	14	7/16-20
			205502.3	8	5/16	1/2-20	24	29	14	17	1/2-20
	350	350	205503.3	10	3/8	9/16-18	27,5	32	14	17	9/16-18
			205504.3	12	1/2	3/4-16	32	37	19	22	3/4-16
			205505.3	14-15-16	5/8	7/8-14	37	43	22	27	7/8-14
			205506.3	18-20	3/4	1 1/16-12	42	49,5	27	32	1 1/16-12
	290	290	205507.3	25	1	1 5/16-12	46	52	33	41	1 5/16-12
	240	240	205508.3	30-32	1 1/4	1 5/8-12	53	58	41	50	1 5/8-12
			205509.3	38	1 1/2	1 7/8-12	59	60	48	55	1 7/8-12
	400	400	205510.3	6	1/4	1/2-20	24	29	14	17	7/16-20
	350	350	205511.3	6	1/4	9/16-18	24	32	14	17	7/16-20
			205512.3	10	3/8	3/4-16	29,5	37	19	22	9/16-18
			205513.3	12	1/2	7/8-14	34	43	22	27	3/4-16
			205514.3	12	1/2	1 1/16-12	36	49,5	27	32	3/4-16
			205515.3	14-15-16	5/8	3/4-16	37	39,5	22	22	7/8-14
			205516.3	14-15-16	5/8	1 1/16-12	39	49,5	27	32	7/8-14
			205517.3	18-20	3/4	3/4-16	42	41,5	27	22	1 1/16-12
	290	290	205518.3	18-20	3/4	7/8-14	42	47	27	27	1 1/16-12
			205519.3	18-20	3/4	1 5/16-12	45	52	33	41	1 1/16-12
	240	240	205520.3	25	1	1 1/16-12	46	49,5	33	32	1 5/16-12
			205521.3	25	1	1 5/8-12	52	58	41	50	1 5/16-12

Notes: If you wish to order a fitting in stainless steel, please change the first two digit from **20....** to **21....** .
Articles available on scheduled orders only.

GAUGE COUPLING

Thread BSP Parallel

Type: 2056...3

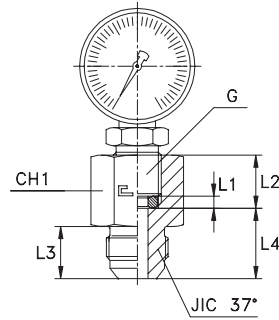

Series JIC	20.... [bar]	21.... [bar]	Ordering Complete	Ø Tube M	Ø Tube W	G	L1	L2	L3	L4	CH1	JIC 37°
UNIVERSAL	350	350	205601.3	6	1/4	1/4	4,5	14,5	13,9	18,5	19	7/16-20
			205602.3	8	5/16	1/4	4,5	14,5	13,9	18,5	19	1/2-20
			205603.3	10	3/8	1/4	4,5	14,5	14	18,5	19	9/16-18
			205604.3	12	1/2	1/4	4,5	14,5	16,7	21,5	22	3/4-16
			205605.3	6	1/4	1/2	5	20	14	20	27	7/16-20
			205606.3	8	5/16	1/2	5	20	14	20	27	1/2-20
			205607.3	10	3/8	1/2	5	20	14,1	20	27	9/16-18
			205608.3	12	1/2	1/2	5	20	16,7	23	27	3/4-16

Notes: If you wish to order a fitting in stainless steel, please change the first two digit from 20.... to 21.... .
Gauge not included.

PORT END ADAPTOR OR TEST POINTS

Thread BSP Parallel

Type: 2057..

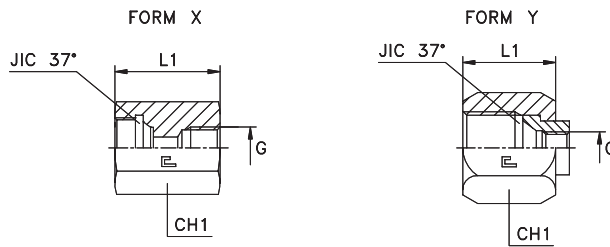

Series JIC	20.... [bar]	21.... [bar]	Ordering Complete	Ø Tube M	Ø Tube W	G	Form	L1	CH1	JIC 37°
UNIVERSAL	350	350	205701	6	1/4	1/4	X	29	19	7/16-20
			205702	8	5/16	1/4	X	29	19	1/2-20
			205703	10	3/8	1/4	X	29	19	9/16-18
			205704	12	1/2	1/4	X	32	22	3/4-16
			205705	14-15-16	5/8	1/4	X	32	27	7/8-14
			205706	18-20	3/4	1/4	Y	25,9	32	1 1/16-12
	290	290	205707	25	1	1/4	Y	28,4	41	1 5/16-12
	240	240	205708	30-32	1 1/4	1/4	Y	31	50	1 5/8-12
			205709	38	1 1/2	1/4	Y	35,8	60	1 7/8-12

Notes: If you wish to order AISI 316 stainless steel fittings, please change the first two digits from 20.... to 21.... .
If you wish to order AISI 316 stainless steel fittings with AISI 304 stainless steel nuts, please change the first two digits from 20.... to 24.... .
Articles available on request only.

MALE STUD COUPLING WITH O-RING AND WASHER

Thread BSP Parallel - Thread Metric Parallel

Type: 2058...3

Type: 2059...3

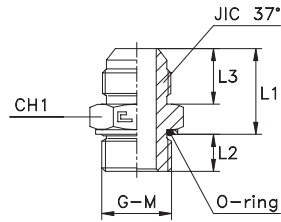

Series JIC	20.... [bar]	21.... [bar]	Ordering Complete	Ø Tube M	Ø Tube W	G	L1	L2	L3	CH1	JIC 37°
UNIVERSAL	350	350	205801.3	6	1/4	1/8	22.3	6.7	13.9	14	7/16-20
			205802.3	8	5/16	1/8	22.3	6.7	13.9	14	1/2-20
			205803.3	10	3/8	1/4	22.8	10.2	14	19	9/16-18
			205804.3	12	1/2	3/8	26.3	10.2	16.7	22	3/4-16
	315	315	205805.3	14-15-16	5/8	1/2	31.3	12.2	19.3	27	7/8-14
			205806.3	18-20	3/4	3/4	34.8	12.7	21.9	36	1 1/16-12
	280	280	205807.3	25	1	1	37.6	15.4	23.1	41	1 5/16-12
	240	240	205808.3	30-32	1 1/4	1 1/4	41	16	24.3	50	1 5/8-12
			205809.3	38	1 1/2	1 1/2	45	16	27.5	55	1 7/8-12
	350	350	205810.3	6	1/4	1/4	22.8	10.2	13.9	19	7/16-20
			205811.3	6	1/4	3/8	23.8	10.2	13.9	22	7/16-20
	315	315	205812.3	6	1/4	1/2	25.8	12.2	13.9	27	7/16-20
	350	350	205813.3	8	5/16	1/4	22.8	10.2	13.9	19	1/2-20
			205814.3	8	5/16	3/8	23.8	10.2	13.9	22	1/2-20
			205815.3	10	3/8	1/8	22.3	6.7	14	17	9/16-18
			205816.3	10	3/8	3/8	23.8	10.2	14	22	9/16-18
	315	315	205817.3	10	3/8	1/2	26.3	12.2	14	27	9/16-18
	350	350	205818.3	12	1/2	1/4	26.3	10.2	16.7	19	3/4-16
	315	315	205819.3	12	1/2	1/2	28.8	12.2	16.7	27	3/4-16
			205820.3	12	1/2	3/4	29.8	12.7	16.7	36	3/4-16
	350	350	205821.3	14-15-16	5/8	3/8	30.3	10.2	19.3	24	7/8-14
	315	315	205822.3	14-15-16	5/8	3/4	32.3	12.7	19.3	36	7/8-14
	350	350	205823.3	18-20	3/4	3/8	33.8	10.2	21.9	30	1 1/16-12
	315	315	205824.3	18-20	3/4	1/2	33.8	12.2	21.9	30	1 1/16-12
	280	280	205825.3	18-20	3/4	1	36.6	15.4	21.9	41	1 1/16-12
	290	290	205826.3	25	1	3/4	35.8	12.7	23.1	36	1 5/16-12
	240	240	205827.3	25	1	1 1/4	39.5	16	23.1	50	1 5/16-12
			205828.3	30-32	1 1/4	1	40.1	15.4	24.3	46	1 5/8-12
			205829.3	30-32	1 1/4	1 1/2	42	16	24.3	55	1 5/8-12
			205830.3	38	1 1/2	1 1/4	44	16	27.5	50	1 7/8-12

Notes: If you wish to order a fitting in stainless steel, please change the first two digit from 20.... to 21.... .
Articles available on request only.

Serie JIC	20.... [bar]	21.... [bar]	Ordering Complete	Ø Tube M	Ø Tube W	M	L1	L2	L3	CH1	JIC 37°
UNIVERSAL	350	350	205901.3	6	1/4	10x1	22.5	7.5	13.9	14	7/16-20
			205902.3	8	5/16	12x1.5	22.4	9.6	13.9	17	1/2-20
			205903.3	10	3/8	14x1.5	22.4	9.6	14	19	9/16-18
			205904.3	12	1/2	16x1.5	26.4	11.1	16.7	22	3/4-16
	315	315	205905.3	14-15-16	5/8	22x1.5	30.9	13.6	19.3	27	7/8-14
			205906.3	18-20	3/4	27x2	34.5	16.5	21.9	32	1 1/16-12
	280	280	205907.3	25	1	33x2	36.5	16.5	23.1	41	1 5/16-12
	240	240	205908.3	30-32	1 1/4	42x2	40.5	17	24.3	50	1 5/8-12
			205909.3	38	1 1/2	48x2	44	19.5	27.5	55	1 7/8-12
	350	350	205910.3	6	1/4	12x1.5	22.4	9.6	13.9	17	7/16-20
			205911.3	8	5/16	10x1	22.5	7.5	13.9	14	1/2-20
			205912.3	8	5/16	14x1.5	22.4	9.6	13.9	19	1/2-20
			205913.3	10	3/8	16x1.5	23.9	11.1	14	22	9/16-18
			205914.3	12	1/2	14x1.5	26.4	9.6	16.7	22	3/4-16
			205915.3	12	1/2	18x1.5	26.9	12.6	16.7	24	3/4-16
			205916.3	14-15-16	5/8	18x1.5	29.9	12.6	19.3	24	7/8-14
			205917.3	14-15-16	5/8	20x1.5	30.9	12.6	19.3	27	7/8-14
	315	315	205918.3	18-20	3/4	22x1.5	33.4	13.6	21.9	27	1 1/16-12
	280	280	205919.3	25	1	27x2	35.5	16.5	23.1	36	1 5/16-12

Notes: If you wish to order a fitting in stainless steel, please change the first two digit from 20.... to 21.... .
Articles available on request only.

MALE STUD COUPLING WITH SWIVEL NUT O-RING AND WASHER

Thread BSP Parallel - Thread Metric Parallel

Type: 2060..
Type: 2061..

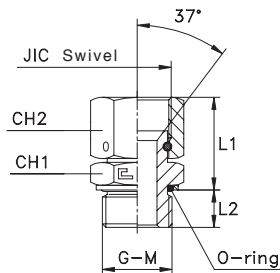

Series JIC	20.... [bar]	21.... [bar]	Ordering Complete	JIC 37°	G	L1	L2	CH1	CH2
UNIVERSAL	350	350	206001	7/16-20	1/8	25,8	6,7	14	14
			206002	1/2-20	1/8	27,3	6,7	14	17
			206003	9/16-18	1/4	28,6	10,2	19	19
			206004	3/4-16	3/8	31,9	10,2	22	22
	315	315	206005	7/8-14	1/2	37,9	12,2	27	27
			206006	1 1/16-12	3/4	39	12,7	36	32
	280	280	206007	1 5/16-12	1	44,5	15,4	41	41
	240	240	206008	1 5/8-12	1 1/4	46,9	16	50	50
			206009	1 7/8-12	1 1/2	54,9	16	55	60
	350	350	206010	7/16-20	1/4	26,3	10,2	19	14
			206011	7/16-20	3/8	27,3	10,2	22	14
			206012	1/2-20	1/4	27,8	10,2	19	17
			206013	1/2-20	3/8	28,8	10,2	22	17
	315	315	206014	9/16-18	3/8	29,6	10,2	22	19
			206015	9/16-18	1/2	32,1	12,2	27	19
	350	350	206016	3/4-16	1/4	30,9	10,2	19	22
			206017	3/4-16	1/2	34,4	12,2	27	22
	315	315	206018	7/8-14	3/8	35,9	10,2	22	27
			206019	7/8-14	3/4	38,9	12,7	36	27
			206020	1 1/16-12	1/2	38	12,2	27	32
			206021	1 1/16-12	1	40,8	15,4	41	32
	280	280	206022	1 5/16-12	3/4	42,7	12,7	36	41
			206023	1 5/16-12	1 1/4	46,5	16	50	41
			206024	1 5/8-12	1	44,9	15,4	41	50
	240	240	206025	1 7/8-12	1 1/4	53,9	16	50	60

Notes: If you wish to order a fitting in stainless steel, please change the first two digit from 20.... to 21.... .
Articles available on request only.

Series JIC	20.... [bar]	21.... [bar]	Ordering Complete	JIC 37°	M	L1	L2	CH1	CH2
UNIVERSAL	350	350	206101	7/16-20	10x1	26	7,5	14	14
			206102	1/2-20	12x1,5	27,4	9,6	17	17
			206103	9/16-18	14x1,5	28,2	9,6	19	19
			206104	3/4-16	16x1,5	32,5	11,1	22	22
	315	315	206105	7/8-14	22x1,5	37,5	13,6	27	27
			206106	1 1/16-12	27x2	38,7	16,5	32	32
	280	280	206107	1 5/16-12	33x2	43,4	16,5	41	41
	240	240	206108	1 5/8-12	42x2	40,3	17	50	50
			206109	1 7/8-12	48x2	53,8	19,5	55	60
	350	350	206110	7/16-20	12x1,5	25,9	9,6	17	14
			206111	1/2-20	10x1	27,5	7,5	14	17
			206112	1/2-20	14x1,5	27,4	9,6	19	17
			206113	9/16-18	16x1,5	29,7	11,1	22	19
			206114	3/4-16	18x1,5	32,5	12,6	24	22
	315	315	206115	7/8-14	18x1,5	36,5	12,6	24	27
			206116	7/8-14	20x1,5	37,5	12,6	27	27
	280	280	206117	1 1/16-12	22x1,5	37,6	13,6	27	32
			206118	1 5/16-12	27x2	42,4	16,5	32	41

Notes: If you wish to order a fitting in stainless steel, please change the first two digit from 20.... to 21.... .
Articles available on request only.

LONG MALE STUD STRAIGHT COUPLING WITH O-RING AND WASHER

Thread BSP Parallel - Thread Metric Parallel

Type: 2062...3

Type: 2063...3

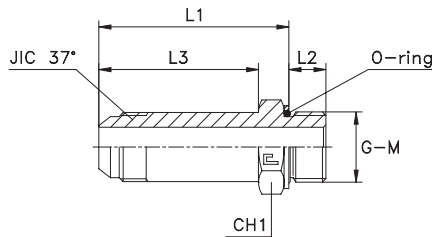

Series JIC	20.... [bar]	21.... [bar]	Ordering Complete	Ø Tube M	Ø Tube W	G	L1	L2	L3	CH1	JIC 37°
UNIVERSAL	350	350	206201.3	6	1/4	1/8	43,3	6,7	35	14	7/16-20
			206202.3	8	5/16	1/8	45,3	6,7	37	14	1/2-20
			206203.3	10	3/8	1/4	47,8	10,2	39	19	9/16-18
			206204.3	12	1/2	3/8	57,8	10,2	48	22	3/4-16
	315	315	206205.3	14-15-16	5/8	1/2	64,8	12,2	53	27	7/8-14
			206206.3	18-20	3/4	3/4	75,8	12,7	63	36	11/16-12
	280	280	206207.3	25	1	1	86,6	15,4	72	41	15/16-12
	240	240	206208.3	30-32	1 1/4	1 1/4	104,5	16	88	50	15/8-12
			206209.3	38	1 1/2	1 1/2	115,5	16	98	55	17/8-12
	350	350	206210.3	6	1/4	1/4	43,8	10,2	35	19	7/16-20
			206211.3	8	5/16	1/4	45,8	10,2	37	19	1/2-20
			206212.3	8	5/16	3/8	46,8	10,2	37	22	1/2-20
			206213.3	10	3/8	3/8	48,8	10,2	39	22	9/16-18
	315	315	206214.3	10	3/8	1/2	50,8	12,2	39	27	9/16-18
	350	350	206215.3	12	1/2	1/4	57,8	10,2	48	22	3/4-16
	315	315	206216.3	12	1/2	1/2	59,8	12,2	48	27	3/4-16
	350	350	206217.3	14-15-16	5/8	3/8	63,8	10,2	53	24	7/8-14
	315	315	206218.3	14-15-16	5/8	3/4	65,8	12,7	53	36	7/8-14
			206219.3	18-20	3/4	1/2	74,8	12,2	63	30	11/16-12
	280	280	206220.3	18-20	3/4	1	77,6	15,4	63	41	11/16-12
	290	290	206221.3	25	1	3/4	84,8	14,2	72	36	15/16-12
	240	240	206222.3	25	1	1 1/4	88,5	16	72	50	15/16-12
			206223.3	30-32	1 1/4	1	103,6	15,4	88	46	15/8-12
			206224.3	38	1 1/2	1 1/4	114,5	16	98	50	17/8-12

Notes: If you wish to order a fitting in stainless steel, please change the first two digit from 20.... to 21.... .
Articles available on request only.

Series JIC	20.... [bar]	21.... [bar]	Ordering Complete	Ø Tube M	Ø Tube W	M	L1	L2	L3	CH1	JIC 37°
UNIVERSAL	350	350	206301.3	6	1/4	10x1	43,5	7,5	35	14	7/16-20
			206302.3	8	5/16	12x1,5	45,4	9,6	37	17	1/2-20
			206303.3	10	3/8	14x1,5	47,4	9,6	39	19	9/16-18
			206304.3	12	1/2	16x1,5	57,9	11,1	48	22	3/4-16
	315	315	206305.3	14-15-16	5/8	22x1,5	64,4	13,6	53	27	7/8-14
			206306.3	18-20	3/4	27x2	75,5	16,5	63	32	11/16-12
	280	280	206307.3	25	1	33x2	85,5	16,5	72	41	15/16-12
	240	240	206308.3	30-32	1 1/4	42x2	104	17	88	50	15/8-12
			206309.3	38	1 1/2	48x2	114,5	19,5	98	55	17/8-12
	350	350	206310.3	8	5/16	10x1	45,5	7,5	37	14	1/2-20
			206311.3	8	5/16	14x1,5	45,4	9,6	37	19	1/2-20
			206312.3	10	3/8	16x1,5	48,9	11,1	39	22	9/16-18
			206313.3	12	1/2	18x1,5	58,4	12,6	48	24	3/4-16
	315	315	206314.3	14-15-16	5/8	18x1,5	63,4	12,6	53	24	7/8-14
			206315.3	14-15-16	5/8	20x1,5	63,4	12,6	53	27	7/8-14
			206316.3	18-20	3/4	22x1,5	74,4	13,6	63	27	11/16-12
	280	280	206317.3	25	1	27x2	84,5	16,5	72	36	15/16-12

Notes: If you wish to order a fitting in stainless steel, please change the first two digit from 20.... to 21.... .
Articles available on request only.

LONG MALE STUD STRAIGHT COUPLING WITH O-RING

Thread UNF/UN-2A

Type: 2064...3

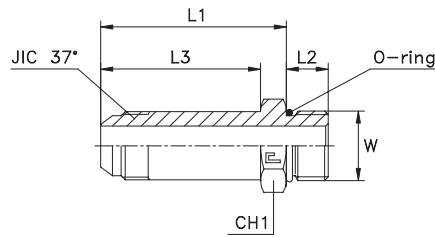

Series JIC	20... [bar]	21... [bar]	Ordering Complete	Ø Tube M	Ø Tube W	W	L1	L2	L3	CH1	JIC 37°
UNIVERSAL	400	400	206401.3	6	1/4	7/16-20	42,9	9,1	35	14	7/16-20
			206402.3	8	5/16	1/2-20	44,9	9,1	37	17	1/2-20
	350	350	206403.3	10	3/8	9/16-18	48	10	39	17	9/16-18
			206404.3	12	1/2	3/4-16	57,9	11,1	48	22	3/4-16
			206405.3	14-15-16	5/8	7/8-14	66,3	12,7	53	27	7/8-14
			206406.3	18-20	3/4	1 1/16-12	75,9	15,1	63	32	1 1/16-12
	290	290	206407.3	25	1	1 5/16-12	85,4	15,1	72	41	1 5/16-12
	240	240	206408.3	30-32	1 1/4	1 5/8-12	103,9	15,1	88	50	1 5/8-12
			206409.3	38	1 1/2	1 7/8-12	114,9	15,1	98	55	1 7/8-12
	400	400	206410.3	6	1/4	1/2-20	42,9	9,1	35	17	7/16-20
			206411.3	6	1/4	9/16-18	43	10	35	17	7/16-20
	350	350	206412.3	10	3/8	3/4-16	48,9	11,1	39	22	9/16-18
			206413.3	12	1/2	7/8-14	59,3	12,7	48	27	3/4-16
			206414.3	12	1/2	1 1/16-12	60,9	15,1	48	32	3/4-16
			206415.3	14-15-16	5/8	3/4-16	63,9	11,1	48	24	7/8-14
			206416.3	14-15-16	5/8	1 1/16-12	65,9	15,1	53	32	7/8-14
			206417.3	18-20	3/4	3/4-16	74,9	11,1	53	30	1 1/16-12
			206418.3	18-20	3/4	7/8-14	75,3	12,7	63	30	1 1/16-12
	290	290	206419.3	18-20	3/4	1 5/16-12	76,9	15,1	63	41	1 1/16-12
			206420.3	25	1	1 1/16-12	84,9	15,1	72	36	1 5/16-12
	240	240	206421.3	25	1	1 5/8-12	87,9	15,1	72	50	1 5/16-12

Notes: If you wish to order a fitting in stainless steel, please change the first two digit from 20.... to 21.... .
Articles available on request only.

LONG MALE STUD ELBOW COUPLING WITH O-RING AND WASHER

Thread BSP Parallel

Type: 2065...3

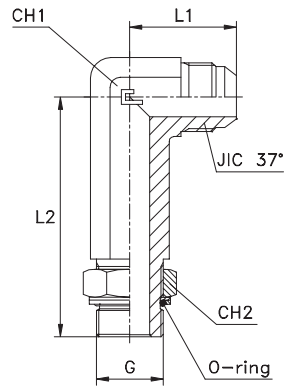

Series JIC	20.... [bar]	21.... [bar]	Ordering Complete	Ø Tube M	Ø Tube W	G	L1	L2	CH1	CH2	JIC 37°
UNIVERSAL	350	350	206501.3	6	1/4	1/8	23	46	11	14	7/16-20
	315	315	206502.3	8	5/16	1/4	24	56,5	14	19	1/2-20
			206503.3	10	3/8	1/4	27,5	56,5	14	19	9/16-18
	250	250	206504.3	12	1/2	3/8	32	67	19	22	3/4-16
			206505.3	14-15-16	5/8	1/2	37	78	22	27	7/8-14
			206506.3	18-20	3/4	3/4	42	92	27	36	1 1/16-12
	200	200	206507.3	25	1	1	46	105	33	41	1 5/16-12
			206508.3	30-32	1 1/4	1 1/4	53	124	41	50	1 5/8-12
	160	160	206509.3	38	1 1/2	1 1/2	59	135	48	55	1 7/8-12
	315	315	206510.3	6	1/4	1/4	24	56,5	14	19	7/16-20
	250	250	206511.3	6	1/4	3/8	29	67	19	22	7/16-20
			206512.3	6	1/4	1/2	31	78	22	27	7/16-20
	350	350	206513.3	8	5/16	1/8	24	49,5	14	14	1/2-20
	250	250	206514.3	8	5/16	3/8	29	67	19	22	1/2-20
			206515.3	10	3/8	3/8	29,5	67	19	22	9/16-18
			206516.3	10	3/8	1/2	31,5	78	22	27	9/16-18
	315	315	206517.3	12	1/2	1/4	32	66,5	19	19	3/4-16
	250	250	206518.3	12	1/2	1/2	34	78	22	27	3/4-16
			206519.3	12	1/2	3/4	36	92	27	36	3/4-16
			206520.3	14-15-16	5/8	3/8	37	74,5	22	22	7/8-14
			206521.3	14-15-16	5/8	3/4	39	92	27	36	7/8-14
			206522.3	18-20	3/4	1/2	42	88	27	27	1 1/16-12
	200	200	206523.3	18-20	3/4	1	45	105	33	41	1 1/16-12
	250	250	206524.3	25	1	3/4	46	104	33	36	1 5/16-12
			206525.3	25	1	1 1/4	52	124	41	50	1 5/16-12
	200	200	206526.3	30-32	1 1/4	1	53	124	41	41	1 5/8-12
			206527.3	38	1 1/2	1 1/4	59	135	48	50	1 7/8-12

Notes: If you wish to order a fitting in stainless steel, please change the first two digit from 20.... to 21....
Articles available on request only.

LONG MALE STUD ELBOW COUPLING WITH O-RING

Thread Metric Parallel

Type: 2066...3

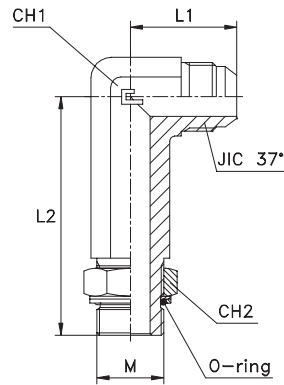

Series JIC	20.... [bar]	21.... [bar]	Ordering Complete	Ø Tube M	Ø Tube W	M	L1	L2	CH1	CH2	JIC 37°
UNIVERSAL	350	350	206601.3	6	1/4	10x1	23	46	11	14	7/16-20
	315	315	206602.3	8	5/16	12x1,5	24	53,5	14	17	1/2-20
			206603.3	10	3/8	14x1,5	27,5	56	14	19	9/16-18
			206604.3	12	1/2	16x1,5	32	67	19	22	3/4-16
	250	250	206605.3	14-15-16	5/8	22x1,5	37	78	22	27	7/8-14
			206606.3	18-20	3/4	27x2	42	95	27	32	1 1/16-12
	200	200	206607.3	25	1	33x2	46	105	33	41	1 5/16-12
			206608.3	30-32	1 1/4	42x2	53	124	41	50	1 5/8-12
	160	160	206609.3	38	1 1/2	48x2	59	137	48	55	1 7/8-12
	315	315	206610.3	6	1/4	12x1,5	24	53,5	14	17	7/16-20
	350	350	206611.3	8	5/16	10x1	24	49,5	14	14	1/2-20
	315	315	206612.3	8	5/16	14x1,5	24	56	14	19	1/2-20
			206613.3	10	3/8	16x1,5	29,5	67	19	22	9/16-18
			206614.3	12	1/2	18x1,5	32	67	19	24	3/4-16
			206615.3	14-15-16	5/8	18x1,5	37	75,5	22	24	7/8-14
	250	250	206616.3	14-15-16	5/8	20x1,5	37	78	22	27	7/8-14
			206617.3	20	3/4	22x1,5	42	88	27	27	1 1/16-12
			206618.3	25	1	27x2	46	105	33	32	1 5/16-12

Notes: If you wish to order a fitting in stainless steel, please change the first two digit from 20.... to 21.... .
Articles available on request only.

LONG MALE STUD ELBOW COUPLING

Coupling with O-Ring
Thread UNF/UN-2A

Type: 2067...3

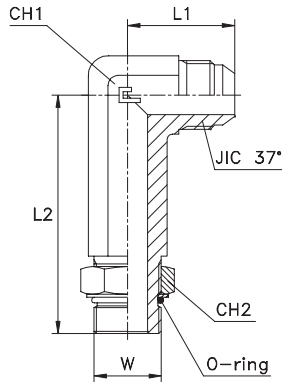

Thread NPTF

Type: 2068...3

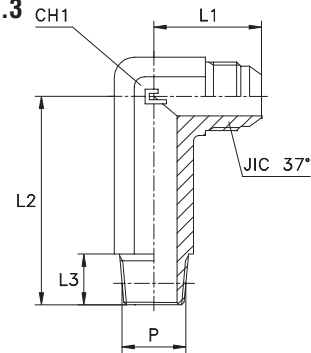

Series JIC	20.... [bar]	21.... [bar]	Ordering Complete	Ø Tube M	Ø Tube W	W	L1	L2	CH1	CH2	JIC 37°
UNIVERSAL	400	400	206701.3	6	1/4	7/16-20	23	46	11	14	7/16-20
			206702.3	8	5/16	1/2-20	24	49,5	14	17	1/2-20
	350	350	206703.3	10	3/8	9/16-18	27,5	56,5	14	17	9/16-18
			206704.3	12	1/2	3/4-16	32	67	19	22	3/4-16
			206705.3	14-15-16	5/8	7/8-14	37	78	22	27	7/8-14
			206706.3	18-20	3/4	1 1/16-12	42	92	27	32	1 1/16-12
	290	290	206707.3	25	1	1 5/16-12	46	105	33	41	1 5/16-12
	240	240	206708.3	30-32	1 1/4	1 5/8-12	53	124	41	50	1 5/8-12
			206709.3	38	1 1/2	1 7/8-12	59	135	48	55	1 7/8-12
	400	400	206710.3	6	1/4	1/2-20	24	49,5	14	17	7/16-20
			206711.3	6	1/4	9/16-18	24	56,5	14	17	7/16-20
	350	350	206712.3	10	3/8	3/4-16	29,5	67	19	22	9/16-18
			206713.3	12	1/2	7/8-14	34	78	22	27	3/4-16
			206714.3	12	1/2	1 1/16-12	36	92	27	32	3/4-16
			206715.3	14-15-16	5/8	3/4-16	37	74,5	22	22	7/8-14
			206716.3	14-15-16	5/8	1 1/16-12	39	92	27	32	7/8-14
			206717.3	18-20	3/4	3/4-16	42	84,5	27	22	1 1/16-12
			206718.3	18-20	3/4	7/8-14	42	88	27	27	1 1/16-12
	290	290	206719.3	18-20	3/4	1 5/16-12	45	105	33	41	1 1/16-12
	240	240	206720.3	25	1	1 1/16-12	46	105	33	32	1 5/16-12
			206721.3	25	1	1 5/8-12	52	124	41	50	1 5/16-12

Notes: If you wish to order a fitting in stainless steel, please change the first two digit from 20.... to 21.... .
Articles available on request only.

Serie JIC	20.... [bar]	21.... [bar]	Ordering Complete	Ø Tube M	Ø Tube W	P	L1	L2	L3	CH1	JIC 37°
UNIVERSAL	350	350	206801.3	6	1/4	1/8	23	39,5	10	11	7/16-20
			206802.3	8	5/16	1/8	24	41,5	10	14	1/2-20
			206803.3	10	3/8	1/4	27,5	52,5	14,5	14	9/16-18
			206804.3	12	1/2	3/8	32	61	14,5	19	3/4-16
			206805.3	14-15-16	5/8	1/2	37	73	19	22	7/8-14
			206806.3	18-20	3/4	3/4	42	82,5	19	27	1 1/16-12
	290	290	206807.3	25	1	1	46	103	24	33	1 5/16-12
	240	240	206808.3	30-32	1 1/4	1 1/4	53	127	25	41	1 5/8-12
			206809.3	38	1 1/2	1 1/2	59	141	26	48	1 7/8-12
	350	350	206810.3	6	1/4	1/4	24	52,5	14,5	14	7/16-20
			206811.3	8	5/16	1/4	24	52,5	14,5	14	1/2-20
			206812.3	10	3/8	1/8	27,5	48,5	10	14	9/16-18
			206813.3	10	3/8	3/8	29,5	61	14,5	19	9/16-18
			206814.3	10	3/8	1/2	31,5	73	19	22	9/16-18
			206815.3	12	1/2	1/4	32	61	14,5	19	3/4-16
			206816.3	12	1/2	1/2	34	73	19	22	3/4-16
			206817.3	12	1/2	3/4	36	82,5	19	27	3/4-16
			206818.3	14-15-16	5/8	3/8	37	68,5	14,5	22	7/8-14
			206819.3	14-15-16	5/8	3/4	39	82,5	19	27	7/8-14
			206820.3	18-20	3/4	1/2	42	82,5	19	27	1 1/16-12
	290	290	206821.3	25	1	3/4	46	98	19	33	1 5/16-12
	240	240	206822.3	30-32	1 1/4	1	53	127	24	41	1 5/8-12

Notes: If you wish to order a fitting in stainless steel, please change the first two digit from 20.... to 21.... .
Articles available on request only.

FEMALE STRAIGHT WELDING COUPLING

Type: 2069...3

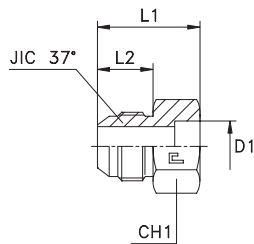

Series JIC	20.... [bar]	21.... [bar]	Ordering Complete	Ø Tube M	Ø Tube W	D1	L1	L2	CH1	JIC 37°
UNIVERSAL	450	450	206901.3	6	1/4	6	26	13,9	12	7/16-20
			206902.3	8	5/16	10	26	13,9	14	1/2-20
	350	350	206903.3	10	3/8	10	27,5	14	17	9/16-18
			206904.3	12	1/2	12	29	16,7	22	3/4-16
			206905.3	14-15-16	5/8	16	31,5	19,3	24	7/8-14
			206906.3	18-20	3/4	20	40	21,9	30	1 1/16-12
	290	290	206907.3	25	1	25	42	23,1	36	1 5/16-12
	240	240	206908.3	30-32	1 1/4	32	45	24,3	46	1 5/8-12
			206909.3	38	1 1/2	38	50	27,5	50	1 7/8-12
	350	350	206910.3	10	3/8	12	27,5	14,1	17	9/16-18
			206911.3	12	1/2	16	29	16,7	22	3/4-16
			206912.3	12	1/2	18	29	16,7	22	3/4-16
			206913.3	14-15-16	5/8	18	31,5	19,3	24	7/8-14
			206914.3	14-15-16	5/8	22	36,5	19,3	27	7/8-14
			206915.3	18-20	3/4	18	40	21,9	30	1 1/16-12
			206916.3	18-20	3/4	25	40	21,9	36	1 1/16-12
	290	290	206917.3	25	1	27	42	23,1	36	1 5/16-12
			206918.3	25	1	32	42,5	23,1	41	1 5/16-12
	240	240	206919.3	30-32	1 1/4	38	45	24,3	50	1 5/8-12

Notes: If you wish to order a fitting in stainless steel, please change the first two digit from 20.... to 21....
Articles available on request only.

MALE WELDING ELBOW

Type: 2070...3

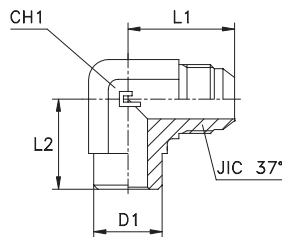

Series JIC	20.... [bar]	21.... [bar]	Ordering Complete	Ø Tube M	Ø Tube W	D1	L1	L2	CH1	JIC 37°
UNIVERSAL	450	450	207001.3	6	1/4	15	31	22,5	14	7/16-20
			207002.3	8	5/16	15	31	22,5	14	1/2-20
	350	350	207003.3	10	3/8	15	31	22,5	14	9/16-18
			207004.3	12	1/2	20	36	26	19	3/4-16
			207005.3	14-15-16	5/8	23	41,5	31	22	7/8-14
			207006.3	18-20	3/4	28	48	34,5	27	1 1/16-12
	290	290	207007.3	25	1	35	52	41	33	1 5/16-12
	240	240	207008.3	30-32	1 1/4	42	59	43	41	1 5/8-12
			207009.3	38	1 1/2	50	66	53	48	1 7/8-12
	450	450	207010.3	8	5/16	16	27	16	14	1/2-20
	350	350	207011.3	10	3/8	16	27	16	14	9/16-18
			207012.3	10	3/8	22	29	18	19	9/16-18
			207013.3	12	1/2	22	31,5	18	19	3/4-16
			207014.3	12	1/2	18	34	20	22	3/4-16
			207015.3	14-15-16	5/8	22	36,5	20	22	7/8-14
			207016.3	14-15-16	5/8	27	40	23	27	7/8-14

Notes: If you wish to order a fitting in stainless steel, please change the first two digit from 20.... to 21....
Articles available on request only.

FEMALE WELDING ELBOW

Type: 2071...3

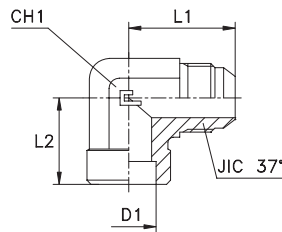

Series JIC	20.... [bar]	21.... [bar]	Ordering Complete	Ø Tube M	Ø Tube W	D1	L1	L2	CH1	JIC 37°
UNIVERSAL	450	450	207101.3	6	1/4	6	23	10	11	7/16-20
			207102.3	8	5/16	10	27	16	14	1/2-20
	350	350	207103.3	10	3/8	10	27,5	16	14	9/16-18
			207104.3	12	1/2	12	32	18	19	3/4-16
			207105.3	14-15-16	5/8	16	37	20	22	7/8-14
			207106.3	18-20	3/4	20	42	23	27	1 1/16-12
	290	290	207107.3	25	1	25	46	26	33	1 5/16-12
	240	240	207108.3	30-32	1 1/4	32	53	33	41	1 5/8-12
			207109.3	38	1 1/2	38	59	35	48	1 7/8-12
	350	350	207110.3	10	3/8	12	29,5	18	19	9/16-18
			207111.3	12	1/2	16	34	20	22	3/4-16
			207112.3	14-15-16	5/8	14	37	20	22	7/8-14
			207113.3	14-15-16	5/8	18	40	23	27	7/8-14
			207114.3	14-15-16	5/8	22	40	23	27	7/8-14
			207115.3	18-20	3/4	18	42	23	27	1 1/16-12
	290	290	207116.3	18-20	3/4	25	46	26	33	1 1/16-12
			207117.3	25	1	32	51	33	41	1 5/16-12
	240	240	207118.3	30-32	1 1/4	30	53	33	41	1 5/8-12
			207119.3	30-32	1 1/4	38	56	35	48	1 5/8-12

Notes: If you wish to order a fitting in stainless steel, please change the first two digit from 20.... to 21.... .
Articles available on request only.

BULKHEAD BARREL TEE

Type: 2072...3

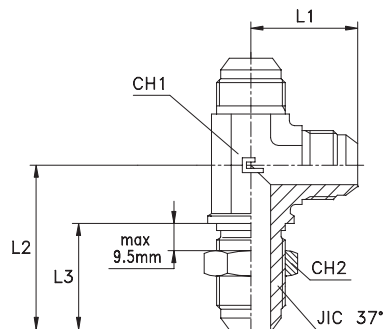

Series JIC	20.... [bar]	21.... [bar]	Ordering Complete	Ø Tube M	Ø Tube W	L1	L2	L3	CH1	CH2	JIC 37°
UNIVERSAL	450	450	207201.3	6	1/4	24,5	40,5	28,3	11	17	7/16-20
			207202.3	8	5/16	27	43,5	28,3	14	19	1/2-20
	350	350	207203.3	10	3/8	27,5	46	30,1	14	22	9/16-18
			207204.3	12	1/2	34,5	53,5	35	19	24	3/4-16
			207205.3	14-15-16	5/8	39,5	60,5	38,5	22	30	7/8-14
			207206.3	18-20	3/4	45	68	42,8	27	36	1 1/16-12
	290	290	207207.3	25	1	49,5	71	42,8	33	41	1 5/16-12
	240	240	207208.3	30-32	1 1/4	55	79	44,1	41	50	1 5/8-12
			207209.3	38	1 1/2	59,5	87	44,3	48	55	1 7/8-12

Notes: If you wish to order a fitting in stainless steel, please change the first two digit from 20.... to 21.... .
Articles available on request only.

FEMALE PLUG

Thread UNF/UN-2B

Type: 2073..

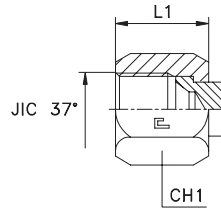

Series JIC	20.... [bar]	21.... [bar]	Ordering Complete	JIC 37°	L1	CH1
UNIVERSAL	450	450	207301	7/16-20	15,5	14
			207302	1/2-20	17	17
	350	350	207303	9/16-18	18,3	19
			207304	3/4-16	21,3	22
			207305	7/8-14	24,6	27
			207306	11/16-12	25,9	32
	290	290	207307	15/16-12	28,4	41
	240	240	207308	15/8-12	31	50
			207309	17/8-12	35,8	60

Notes: If you wish to order a fitting in stainless steel, please change the first two digit from 20.... to 21....
If you wish to order AISI 304 stainless steel fittings, please change the first two digits from 20.... to 44....

TUBE PLUG

Thread UNF/UN-2A

Type: 2074...3

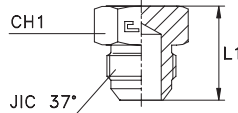

CLOSURE PLUG WITH EXAGON SOCKET HEAD WITH O-RING

Thread UNF/UN-2A

Type: 2075..

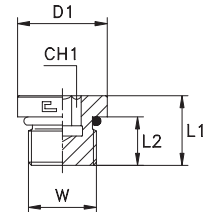

Series JIC	20.... [bar]	21.... [bar]	Ordering Complete	Ø Tube M	Ø Tube W	L1	CH1	JIC 37°
UNIVERSAL	450	450	207401.3	6	1/4	20,5	12	7/16-20
			207402.3	8	5/16	20,5	14	1/2-20
	350	350	207403.3	10	3/8	21,5	17	9/16-18
			207404.3	12	1/2	24	22	3/4-16
			207405.3	14-15-16	5/8	28	24	7/8-14
			207406.3	18-20	3/4	32,5	30	11/16-12
	290	290	207407.3	25	1	34	36	15/16-12
	240	240	207408.3	30-32	11/4	37	46	15/8-12
			207409.3	38	11/2	42	50	17/8-12

Notes: If you wish to order a fitting in stainless steel, please change the first two digit from 20.... to 21....

Series JIC	20.... [bar]	21.... [bar]	Ordering Complete	W	D1	L1	L2	CH1
UNIVERSAL	450	450	207501	7/16-20	14	12	9,1	5
			207502	1/2-20	16	12	9,1	5
	350	350	207503	9/16-18	17,5	13	10	6
			207504	3/4-16	22	14,7	11,1	8
			207505	7/8-14	25,5	16,5	12,7	10
			207506	11/16-12	32	19,5	15,1	14
	290	290	207507	15/16-12	38	19,5	15,1	16
	240	240	207508	15/8-12	48	19,5	15,1	19
			207509	17/8-12	54	19,5	15,1	19

Notes: If you wish to order a fitting in stainless steel, please change the first two digit from 20.... to 21.... .Articoli disponibili su richiesta.

EXAGONAL NUT - Thread UNF/UN-2B

Type: 2076..

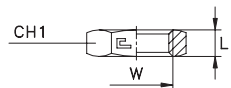

Series JIC	20.... [bar]	21.... [bar]	Ordering Complete	W	L1	CH1
UNIVERSAL	450	450	207601	7/16-20	7,1	17
			207602	1/2-20	7,1	19
	350	350	207603	9/16-18	7,1	22
			207604	3/4-16	7,9	24
			207605	7/8-14	9,1	30
			207606	11/16-12	10,4	36
	290	290	207607	15/16-12	10,5	41
	240	240	207608	15/8-12	10,5	50
			207609	17/8-12	10,5	55

Notes: If you wish to order a fitting in stainless steel, please change the first two digit from 20.... to 21....

EQUAL NON RETURN VALVE

Thread UNF/2A

Type: 5014...3

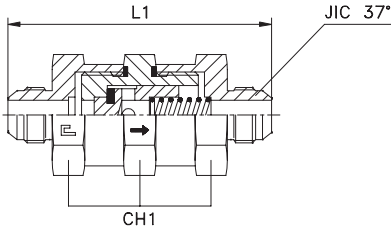

MALE STUD NON RETURN VALVE

With elastomer seal Thread BSP Parallel/
Thread Metric Parallel

Type: 5015...3

Type: 5016...3

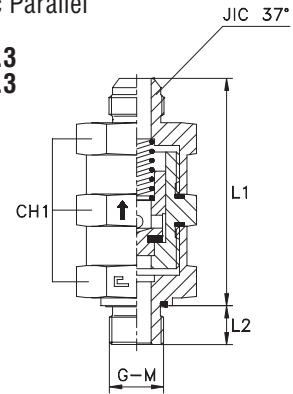

Serie JIC	50.... [bar]	51.... [bar]	Ordering Complete	Ø Tube M	Ø Tube W	L1	CH1	Ø pass.	JIC 37°
UNIVERSAL	400	400	501401.3	6	1/4	76	19	2,8	7/16-20
			501402.3	8	5/16	76	19	4	1/2-20
	350	350	501403.3	10	3/8	76	19	4	9/16-18
			501404.3	12	1/2	87,4	32	8	3/4-16
			501405.3	14-15-16	5/8	95,6	41	11	7/8-14
			501406.3	18-20	3/4	109,8	50	14,5	1 1/16-12
	290	290	501407.3	25	1	112,2	50	18	15/16-12
	240	240	501408.3	30-32	1 1/4	132,6	70	25,5	15/8-12
			501409.3	38	1 1/2	139	70	29	1 7/8-12

Notes: If you wish to order a fitting in stainless steel, please change the first two digit from 50.... to 51.... .

Serie JIC	50.... [bar]	51.... [bar]	Ordering Complete	Ø Tube M	Ø Tube W	G	L1	L2	CH1	Ø pass.	JIC 37°
UNIVERSAL	350	350	501501.3	6	1/4	1/8	64	8	19	2,8	7/16-20
			501502.3	8	5/16	1/8	64	8	19	4	1/2-20
			501503.3	10	3/8	1/4	64,1	12	19	4	9/16-18
			501504.3	12	1/2	3/8	73,2	12	32	8	3/4-16
			501505.3	14-15-16	5/8	1/2	79,3	14	41	11	7/8-14
			501506.3	18-20	3/4	3/4	90,9	16	50	14,5	1 1/16-12
	290	290	501507.3	25	1	1	92,1	18	50	18	15/16-12
	240	240	501508.3	30-32	1 1/4	1 1/4	111,3	20	70	25,5	15/8-12
			501509.3	38	1 1/2	1 1/2	114,5	22	70	29	1 7/8-12

Notes: If you wish to order a fitting in stainless steel, please change the first two digit from 50.... to 51.... .

Serie JIC	50.... [bar]	51.... [bar]	Ordering Complete	Ø Tube M	Ø Tube W	M	L1	L2	CH1	Ø pass.	JIC 37°
UNIVERSAL	350	350	501601.3	6	1/4	10x1	64	8	19	2,8	7/16-20
			501602.3	8	5/16	12x1,5	64	8	19	4	1/2-20
			501603.3	10	3/8	14x1,5	64,1	12	19	4	9/16-18
			501604.3	12	1/2	16x1,5	73,2	12	32	8	3/4-16
			501605.3	14-15-16	5/8	22x1,5	79,3	14	41	11	7/8-14
			501606.3	18-20	3/4	27x2	90,9	16	50	14,5	1 1/16-12
	290	290	501607.3	25	1	33x2	92,1	18	50	18	15/16-12
	240	240	501608.3	30-32	1 1/4	42x2	111,3	20	70	25,5	15/8-12
			501609.3	38	1 1/2	48x2	114,5	22	70	29	1 7/8-12

Notes: If you wish to order a fitting in stainless steel, please change the first two digit from 50.... to 51.... .

MALE STUD NON RETURN VALVE

With elastomer seal Thread BSP Parallel
Thread Metric Parallel

Type: 5017...3
Type: 5018...3

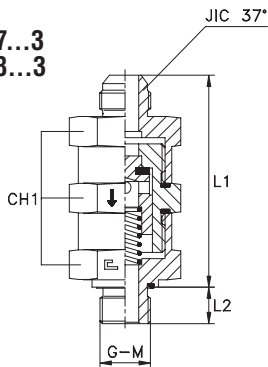

Thread UNF/UN-2A

Type: 5019...3

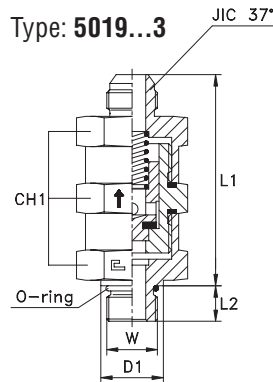

Thread UNF/UN-2A

Type: 5020...3

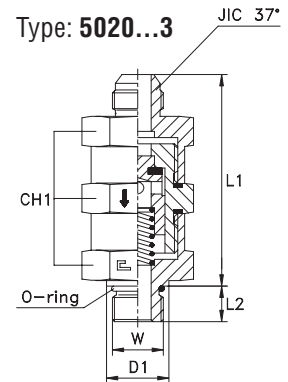

Serie JIC	50.... [bar]	51.... [bar]	Ordering Complete	Ø Tube M	Ø Tube W	G	L1	L2	CH1	Ø pass.	JIC 37°
UNIVERSAL	350	350	501701.3	6	1/4	1/8	64	8	19	2,8	7/16-20
			501702.3	8	5/16	1/8	64	8	19	4	1/2-20
			501703.3	10	3/8	1/4	64,1	12	19	4	9/16-18
			501704.3	12	1/2	3/8	73,2	12	32	8	3/4-16
			501705.3	14-15-16	5/8	1/2	79,3	14	41	11	7/8-14
			501706.3	18-20	3/4	3/4	90,9	16	50	14,5	1 1/16-12
	290	290	501707.3	25	1	1	92,1	18	50	18	15/16-12
	240	240	501708.3	30-32	1 1/4	1 1/4	111,3	20	70	25,5	15/8-12
			501709.3	38	1 1/2	1 1/2	114,5	22	70	29	1 7/8-12

Notes: If you wish to order a fitting in stainless steel, please change the first two digit from 50.... to 51.... .

Serie JIC	50.... [bar]	51.... [bar]	Ordering Complete	Ø Tube M	Ø Tube W	M	L1	L2	CH1	Ø pass.	JIC 37°
UNIVERSAL	350	350	501801.3	6	1/4	10x1	64	8	19	2,8	7/16-20
			501802.3	8	5/16	12x1,5	64	8	19	4	1/2-20
			501803.3	10	3/8	14x1,5	64,1	12	19	4	9/16-18
			501804.3	12	1/2	16x1,5	73,2	12	32	8	3/4-16
			501805.3	14-15-16	5/8	22x1,5	79,3	14	41	11	7/8-14
			501806.3	18-20	3/4	27x2	90,9	16	50	14,5	1 1/16-12
	290	290	501807.3	25	1	33x2	92,1	18	50	18	15/16-12
	240	240	501808.3	30-32	1 1/4	42x2	111,3	20	70	25,5	15/8-12
			501809.3	38	1 1/2	48x2	114,5	22	70	29	1 7/8-12

Notes: If you wish to order a fitting in stainless steel, please change the first two digit from 50.... to 51.... .

Serie JIC	50.... [bar]	51.... [bar]	Ordering Complete	Ø Tube M	Ø Tube W	W	D1	L1	L2	CH1	Ø pass.	JIC 37°
UNIVERSAL	400	400	501901.3	6	1/4	7/16-20	13,8	62,5	9,1	19	2,8	7/16-20
			501902.3	8	5/16	1/2-20	16,8	62,5	9,1	19	4	1/2-20
	350	350	501903.3	10	3/8	9/16-20	16,8	62,1	10	19	4	9/16-18
			501904.3	12	1/2	3/4-16	21,8	70,7	11,1	32	8	3/4-16
			501905.3	14-15-16	5/8	7/8-14	26,8	76,3	12,7	41	11	7/8-14
			501906.3	18-20	3/4	1 1/16-12	31,8	87,9	15,1	50	14,5	1 1/16-12
	290	290	501907.3	25	1	15/16-12	40,8	89,1	15,1	50	18	15/16-12
	240	240	501908.3	30-32	1 1/4	15/8-12	49,8	108,3	15,1	70	25,5	15/8-12
			501909.3	38	1 1/2	1 7/8-12	54,8	111,5	15,1	70	29	1 7/8-12

Notes: Desiderando ordinare il raccordo prescelto in acciaio inox, sostituire nel codice il 50.... iniziale con 51.... .
Articles available on request only.

Serie JIC	50.... [bar]	51.... [bar]	Ordering Complete	Ø Tube M	Ø Tube W	W	D1	L1	L2	CH1	Ø pass.	JIC 37°
UNIVERSAL	400	400	502001.3	6	1/4	7/16-20	13,8	62,5	9,1	19	2,8	7/16-20
			502002.3	8	5/16	1/2-20	16,8	62,5	9,1	19	4	1/2-20
	350	350	502003.3	10	3/8	9/16-20	16,8	62,1	10	19	4	9/16-18
			502004.3	12	1/2	3/4-16	21,8	70,7	11,1	32	8	3/4-16
			502005.3	14-15-16	5/8	7/8-14	26,8	76,3	12,7	41	11	7/8-14
			502006.3	18-20	3/4	1 1/16-12	31,8	87,9	15,1	50	14,5	1 1/16-12
	290	290	502007.3	25	1	15/16-12	40,8	89,1	15,1	50	18	15/16-12
	240	240	502008.3	30-32	1 1/4	15/8-12	49,8	108,3	15,1	70	25,5	15/8-12
			502009.3	38	1 1/2	1 7/8-12	54,8	111,5	15,1	70	29	1 7/8-12

Notes: If you wish to order a fitting in stainless steel, please change the first two digit from 50.... to 51.... .
Articles available on request only.

OFFICES OF CASALGRASSO (CN)

Board of Direction of CAST S.p.A.





BS-5200































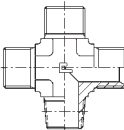

















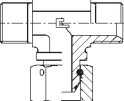
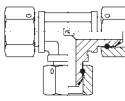

30

BS

AVAILABLE IN CARBON AND STAINLESS STEEL

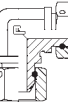
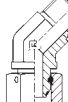
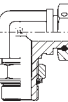
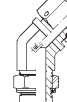
FIGURATIVE INDEX – FITTINGS BS 5200 - ISO 8434-6

General instructions	Quality assurance	Allowed temperatures	Finish treatments	Tubes to be used	Threaded ends	Prescriptions to comply with
Utilisation standards	Safety factors	Seals on threads	End treatments	Tables follow up	Gas - Metric UNF - NPT	Assembly instructions
Page 158	Page 22	Page 23	Page 24	Page 25-26	Page 27-32	Page 33;39-159
Type: 3001.. BSPT Type: 3002.. NPT 	Type: 3003.. BSPP/con. Type: 3004.. BSPP/NPT 	Type: 3005.. BSPP 	Type: 3005..ATT BSPP 	Type: 3006.. Metric paral. 	Type: 3007.. BSPP/Metric paral. 	Type: 3008.. BSPP Type: 3009.. Metric paral. 
Page 160	Page 161	Page 162-163	Page 164	Page 164	Page 165	Page 166
Type: 3010.. BSPT Type: 3011.. NPT 	Type: 3012.. BSPP Type: 3013.. Metric paral. 	Type: 3014.. BSPT Type: 3015.. NPT 	Type: 3016.. BSPP Type: 3017.. Metric paral. 	Type: 3018.. BSPP Type: 3019.. Metric paral. 	Type: 3020.. BSPT Type: 3021.. NPT 	Type: 3022.. BSPP/con. Type: 3023.. BSPP/NPT 
Page 167	Page 168	Page 169	Page 170	Page 171	Page 172	Page 173
Type: 3024.. BSPP Type: 3025.. Metric paral. 	Type: 3026.. BSPP/con. Type: 3027.. BSPP/NPT 	Type: 3028.. BSPP Type: 3029.. Metric paral. 	Type: 3030.. BSPP/con. Type: 3031.. BSPP/NPT 	Type: 3032.. BSPP/con. Type: 3033.. BSPP/NPT 	Type: 3034.. BSPP Type: 3035.. Metric paral. 	Type: 3036.. BSPP 
Page 174	Page 175	Page 176	Page 177	Page 178	Page 179	Page 180
Type: 3037.. BSPP/NPT 	Type: 3038.. BSPP/con. 	Type: 3039.. NPT 	Type: 3040.. BSPP/con. 	Type: 3041.. NPT 	Type: 3042.. BSPP 	Type: 3043.. NPT 
Page 180	Page 181	Page 181	Page 182	Page 182	Page 183	Page 183
Type: 3044.. BSPP 	Type: 3045.. NPT 	Type: 3046.. BSPP/con. 	Type: 3047.. NPT 	Type: 3048.. BSPP/con. Type: 3049.. NPT 	Type: 3050.. BSPP Type: 3051.. NPT 	Type: 3052.. BSPP Type: 3053.. NPT 
Page 184	Page 184	Page 185	Page 185	Page 186	Page 187	Page 187
Type: 3054.. BSPP Type: 3055.. Metric paral. 	Type: 3056.. BSPP Type: 3057.. Metric paral. 	Type: 3058.. BSPP Type: 3059.. Metric paral. 	Type: 3060.. BSPP Type: 3061.. Metric paral. 	Type: 3062.. BSPP/con. Type: 3063.. BSPP/NPT 	Type: 3064.. BSPP Type: 3065.. Metric paral. 	Type: 3066.. BSPP Type: 3067.. Metric paral. 
Page 188	Page 189	Page 190	Page 191	Page 192	Page 193	Page 194
Type: 3068.. BSPP Type: 3069.. Metric paral. 	Type: 3070.. BSPP Type: 3071.. Metric paral. 	Type: 3072.. BSPP 	Type: 3073.. BSPP 	Type: 3074.. BSPP Type: 3075.. Metric paral. 	Type: 3076.. BSPP Type: 3077.. Metric paral. 	Type: 3078.. BSPP 
Page 195	Page 196	Page 197	Page 197	Page 198	Page 199	Page 200
Type: 3079.. BSPP 	Type: 3080.. BSPP Type: 3081.. Metric paral. 	Type: 3082.. BSPP Type: 3083.. Metric paral. 	Type: 3084.. BSPP Type: 3085.. Metric paral. 	Type: 3086.. BSPP Type: 3087.. Metric paral. 	Type: 0023.. BSPP 	Type: 5010.. BSPP Type: 5011.. Metr. cilind. Type: 5012.. BSPT Type: 5013.. NPT 
Page 200	Page 201	Page 202	Page 203	Page 204	Page 205	Page 205-206

ORDERING EXAMPLES (Carbon steel)

ORDERING EXAMPLES (Stainless steel)

BS

- If you require a straight adapter with 3/4" BSP parallel thread made of carbon steel, order: 300518

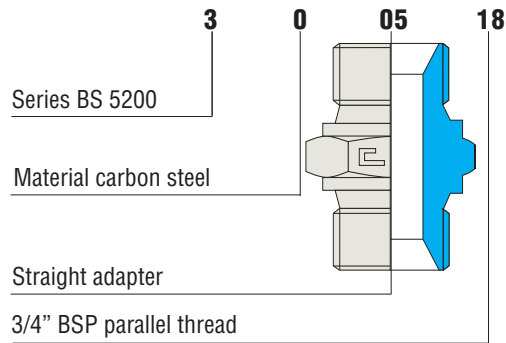

BS

- If you require a straight adapter with 3/4" BSP parallel thread made of stainless steel, order: 310518

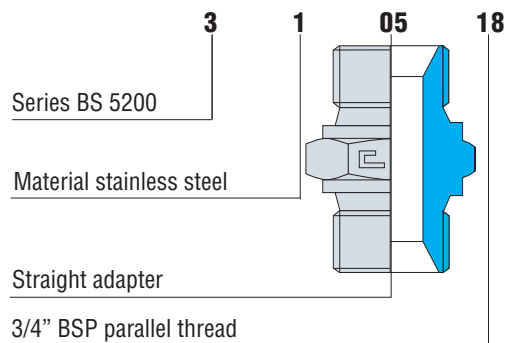

New 60° adapter with elastomeric seal designed by CAST.

BS

- If you require a straight adapter with swivel nut with 3/4" BSP parallel thread made of carbon steel, order: 301606

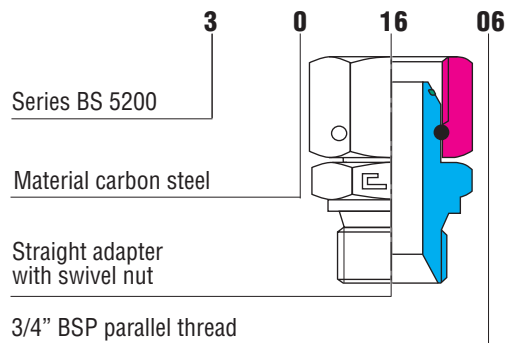

BS

- If you require a straight adapter with swivel nut with 3/4" BSP parallel thread made of stainless steel, order: 311606

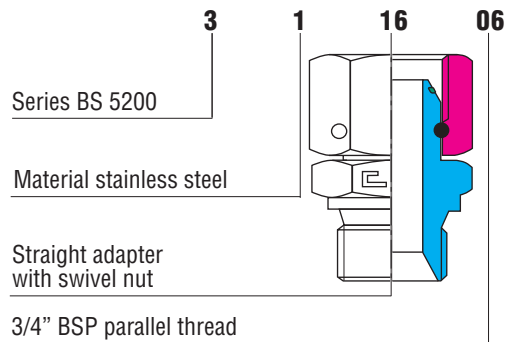

DELIVERIES

- Cast S.p.A. fittings are delivered in the configurations shown in the pictures of this catalogue.
- Available on scheduled orders only: it means that the article is slow moving and will be delivered within 90 days.
- Available on request only: it means that the article is not commonly in stock; please contact our offices for further delivery details.

THEORY OF OPERATION

The Cast fitting, manufactured according to BS 5200, is a mechanical adapter traditionally used for high pressure fluid-dynamic systems. The sealing is made between two conical surfaces, metal to metal, with no deformation of the components, plus an elastomeric sealing (O-Ring) placed into a groove on the 60° cone.

N.B. The elastomeric seal is made according to a CAST S.p.A. project.

The connection between the body of the adapter and the body of the component is guaranteed by the swivel tightening nut and the threaded parts for the other types. It helps fast assembly of removable tubes, avoids welding and tapping, thus assuring maximum simplicity for complex oleo-dynamic systems. Repeated assemblies do not alter the performance of the coupling.

COUPLING SYSTEM BS 5200

Traceability decoding:

CAST =
Logo of the
Manufacturer

- T =
Production plant
- 3 =
Year of manufacture
- CE =
Made in EEC
- 50 =
Type of steel used
- 01 =
Heat number of the
steel used

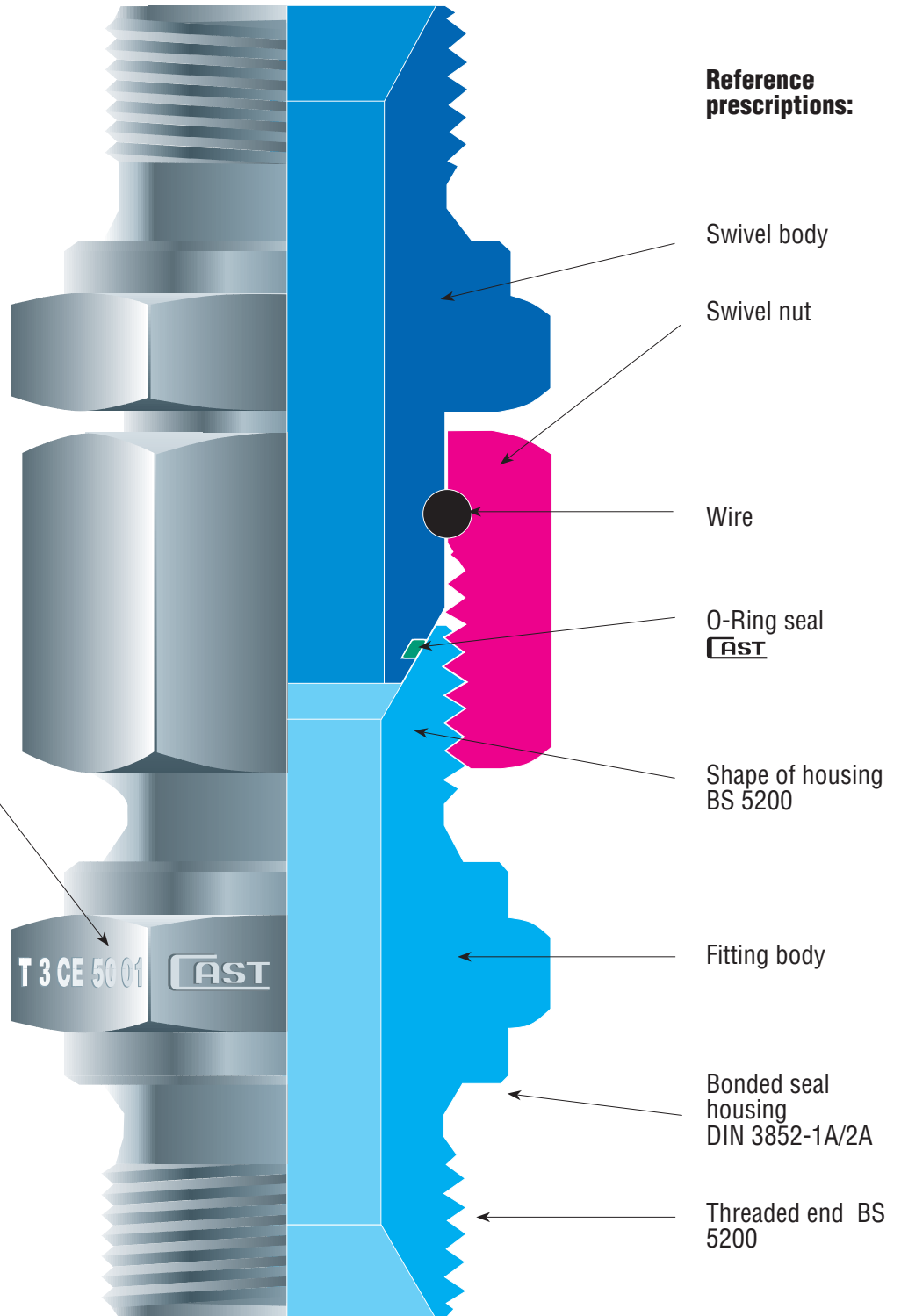

Reference prescriptions:

- Swivel body
- Swivel nut
- Wire
- O-Ring seal
CAST
- Shape of housing
BS 5200
- Fitting body
- Bonded seal
housing
DIN 3852-1A/2A
- Threaded end BS
5200

TECHNICAL CHARACTERISTICS

Cast 60° fittings assure perfect seal regardless of the fluid used, provided that no corrosive fluids be employed, the nominal pressures of the fittings and the indicated temperatures be respected and the prescriptions of the manufacturer be followed scrupulously.

These fittings are manufactured in a single series defined "UNIVERSAL" and combine the various (regulatory) series of fittings: DIN 2353- SAE J514- SAE J1453- SAE J516 etc.

Normal vibrations do not alter the functionality of this type of fitting, also at the top quoted values. Therefore the fitting maintains its best characteristics of absolute guarantee, safety and reliability. For these specific reasons this fitting may be used in hard working conditions.

Under the mechanical strength given by the tightening of the nut on the fitting body, the conical male part couples with the conical female part of the fitting body to provide a very effective metal to metal seal supported by the elastomeric seal as well.

Before assembly

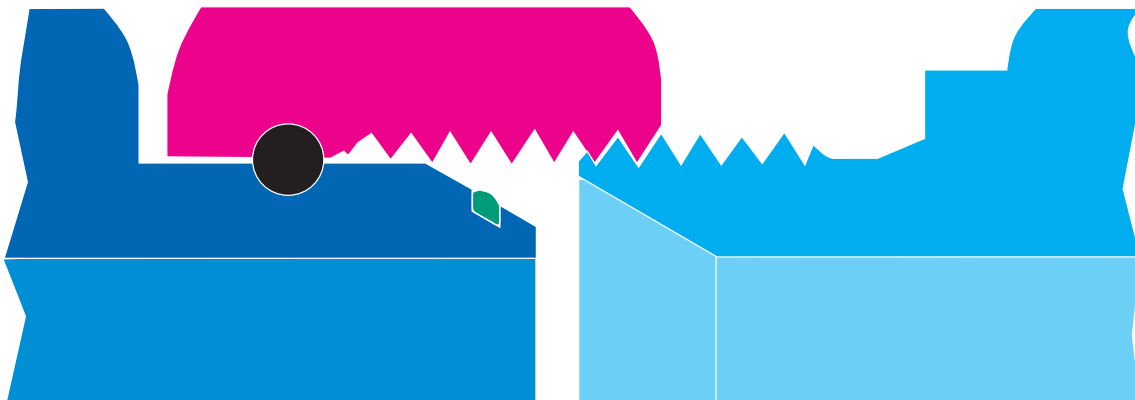

After assembly

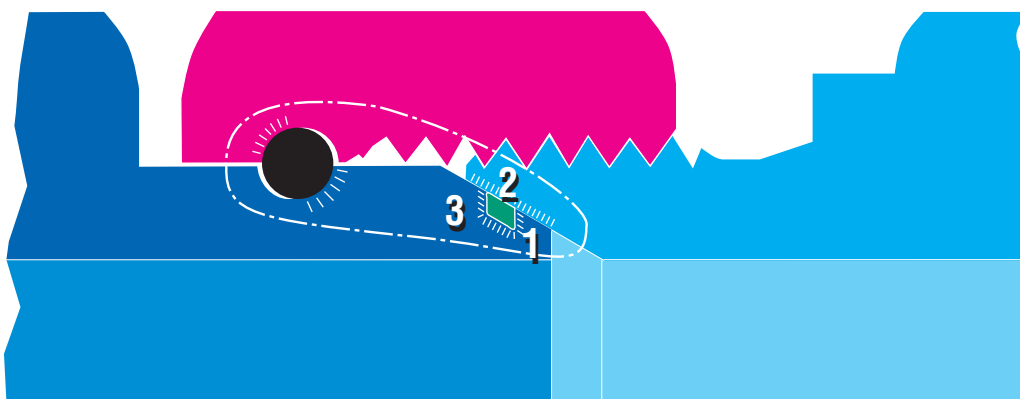

Pressure surfaces

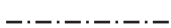

Superfici di pressione



Sealing points

1 - 2 - 3

PRODUCT CONCEPT

- The idea has been to use the standard 60° adapter structure and place an O-ring in the 60° conical part to add an elastomeric seal to the traditional metal to metal seal.
- The new adapter with elastomeric seal solves the problem of small leakages, leaks and sweating that are typical of a metal to metal sealing system on high pressure fittings.
- The introduction of the new adapter with elastomeric seal in any case does not limit the required performance for adapters with or without elastomeric seal.

SEALING

The new adapter solves the total sealing problem in the following way:

- A groove was created on the diameter of the 60° cone as insert place for an O-ring. This elastomeric seal guarantees a perfect seal at all times.
- Creating the groove on the 60° cone has allowed us to improve the metal to metal sealing characteristics by dividing the taper sealing surface of the fitting in two.
- Strenuous tests carried out in our technical laboratory in Casalgrasso (CN) have clarified, beyond any doubt, the reliability of the sealing with or without the O-ring itself.
- We can thus state that this new type of adapter is to be used preferably in combination with the elastomeric seal (O-ring) to ensure a sealing system as dry as dust.
- However, if due to temperature or fluid requirements, the adapter can not be used with the O-ring, the new adapter can be equally used without O-ring, with the certainty that the improved metal to metal seal will ensure the required sealing characteristics.

GENERAL INSTRUCTIONS

- Before starting any operation, please check that all the tools to be used in the process conform to the standards. Carefully check the tools every 30-50 assemblies.
- Before fastening the components to the system onboard the machine, check the alignment between the tube and the fitting.
- Fittings must not be used to correct any misalignment or to support tubes.
- Long tubes or those liable to high stress must be clamped to avoid excessive vibrations. A poor alignment could damage the operation of the system.
- The proper lubrication of the components involved in the tightening is essential for good system operation. We advise the use of mineral oils or torquen tension for carbon steel fittings, consisting of anti-seizing compound (Nickel based), Chesterton or similar, for stainless steel fittings.
- The fittings and the valves in this technical catalogue may be used for fluid-dynamic connections only. Indicated pressures are for steel tubes only.
- Mixing carbon and stainless steel components is not allowed.
- Indicated pressures are for steel tubes only.

UTILISATION STANDARDS

CARBON STEEL FITTINGS

- High quality tubes must be employed to assure correct use and related technical performance of the carbon steel fitting. The use of tubes without the aforementioned characteristics may seriously impair the efficiency of the fitting. CAST S.p.A. recommends using the following tubes only: calibrated and polished, cold drawn seamless tubes, normalised with inert gas, in E235 material according to EN 10305-4 (ST 37.4 according to DIN 1630 I DIN 2391); the maximum permitted hardness, measured on the outer diameter of the tube, is 75 HRB.

STAINLESS STEEL FITTINGS

- High quality tubes must be employed to assure correct use and related technical performance of stainless steel fittings. The use of tubes without the aforementioned characteristics may seriously impair the efficiency of the fitting. CAST S.p.A. recommends using the following tubes only: calibrated and polished, cold drawn seamless tubes 1.4571 as per UNI EN 10216-5 or ASTM A 269; the maximum permitted hardness, measured on the outer diameter of the tube, is 85 HRB.

TIGHTENING TORQUES ON THE SWIVEL CONE

BS 5200 cone for carbon and stainless steel

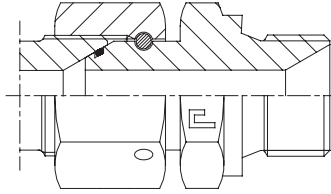

Series	Gas Thread	Torque (Nm) ^{+10%} / ₀	Metric Thread	Torque (Nm) ^{+10%} / ₀
UNIVERSAL	G 1/8	25	M12x1,5	35
	G 1/4	65	M14x1,5	45
	G 3/8	85	M16x1,5	55
	G 1/2	150	M18x1,5	70
	G 5/8	200	M20x1,5	80
	G 3/4	260	M22x1,5	100
	G 1	320	M26x1,5	170
	G 1 1/4	500	M30x1,5	250
	G 1 1/2	600		
	G 2	700		

Notes:

The values in the tightening tables are approximate and derive from practical tests run at the laboratory in Casalgrasso (CN), which may vary based on the materials and tolerances of the components used. Thus an awareness of the controls to be performed is required.

All the values expressed in Newton Meters (Nm) for the tightening torques on the BS 5200 swivel cone represent the torquing moment needed to obtain the correct tightness.

SAFETY FACTORS

The technical choice to use the wire, rather than the crimped fittings, is made in compliance with the highest safety standards. This prerogative is also confirmed by the use of stainless steel wire in the wiring of our products, which guarantees the safety of the product for a lot longer, also in the presence of a particularly aggressive microclimate.

EXAMPLE OF DESTRUCTIVE TESTING

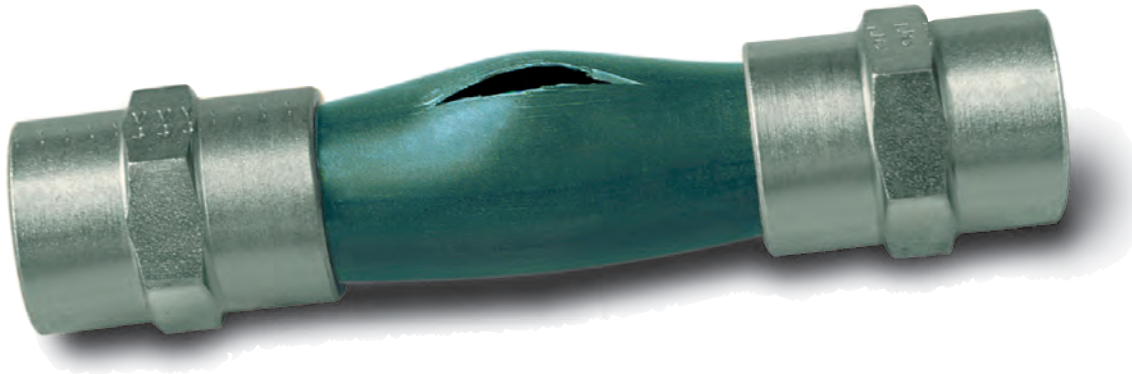

Destructive testing with 22x2 carbon steel tube
The tube burst at 800 bars without any leakage or sweating from the sealing points.

MALE STRAIGHT ADAPTER

Thread BSP Taper

Type: **3001..**

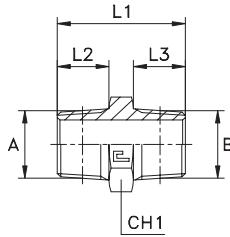

Series BS	30.... [bar]	31.... [bar]	Ordering Complete	A	B	L1	L2	L3	CH1
UNIVERSAL	350	350	300101	1/8	1/8	25	10	10	12
			300102	1/8	1/4	30,5	10	14,5	14
			300103	1/4	1/4	35	14,5	14,5	14
	250	250	300104	1/4	3/8	35	14,5	14,5	17
			300105	3/8	3/8	35	14,5	14,5	17
	225	225	300106	3/8	1/2	40,5	14,5	19	22
			300107	1/2	1/2	45	19	19	22
	200	200	300108	1/2	3/4	47	19	19	27
			300109	3/4	3/4	47	19	19	27
	160	160	300110	3/4	1	53	19	24	36
			300111	1	1	58	24	24	36
			300112	1 1/4	1 1/4	62	25	25	46
			300113	1 1/2	1 1/2	66	26	26	50
	100	100	300114	2	2	69	26	26	65
	250	250	300115	3/8	1/8	30,5	14,5	10	17
	225	225	300116	1/2	1/4	40,5	19	14,5	22
	200	200	300117	3/4	1/4	42,5	19	14,5	27
	160	160	300118	1 1/4	1	61	25	24	46

Notes: If you wish to order a fitting in stainless steel, please change the first two digit from **30....** to **31....** .

MALE STRAIGHT ADAPTER

Thread NPT

Type: **3002..**

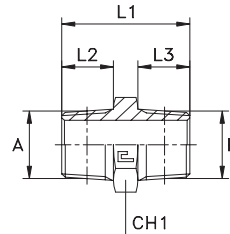

Series BS	30.... [bar]	31.... [bar]	Ordering Complete	A	B	L1	L2	L3	CH1
UNIVERSAL	350	350	300201	1/8	1/8	26	10	10	12
			300202	1/8	1/4	30,5	10	14,5	14
			300203	1/4	1/4	35	14,5	14,5	14
	250	250	300204	1/4	3/8	35	14,5	14,5	17
			300205	3/8	3/8	35	14,5	14,5	17
	225	225	300206	3/8	1/2	40,5	14,5	19	22
			300207	1/2	1/2	45	19	19	22
	200	200	300208	1/2	3/4	47	19	19	27
			300209	3/4	3/4	47	19	19	27
	160	160	300210	3/4	1	53	19	24	36
			300211	1	1	58	24	24	36
			300212	1 1/4	1 1/4	62	25	25	46
			300213	1 1/2	1 1/2	66	26	26	50
	100	100	300214	2	2	69	26	26	65
	250	250	300215	3/8	1/8	30,5	14,5	10	17
	225	225	300216	1/2	1/4	40,5	19	14,5	22
	200	200	300217	3/4	1/4	42,5	19	14,5	27
	160	160	300218	1 1/4	1	61	25	24	46

Notes: If you wish to order a fitting in stainless steel, please change the first two digit from **30....** to **31....** .

MALE STUD STRAIGHT ADAPTER THREAD

Thread BSP Parallel/BSP Taper

Type: **3003..**

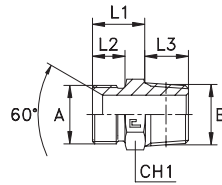

Series BS	30.... [bar]	31.... [bar]	Ordering Complete	A	B	L1	L2	L3	CH1
UNIVERSAL	350	350	300301	1/8	1/8	13	8	10	12
			300302	1/8	1/4	14	8	14,5	14
			300303	1/4	1/4	17	11	14,5	14
	250	250	300304	1/4	3/8	17	11	14,5	17
			300305	3/8	3/8	18	12	14,5	17
	225	225	300306	3/8	1/2	19	12	19	22
			300307	1/2	1/2	21	14	19	22
	200	200	300308	1/2	3/4	23	14	19	27
			300309	3/4	3/4	25	16	19	27
			300310	3/4	1	26	16	24	36
	160	160	300311	1	1	29	19	24	36
			300312	1	1/4	31	19	25	46
			300313	1 1/4	1/4	32	20	25	46
			300314	1 1/4	1/2	34	20	26	50
			300315	1 1/2	1/2	37	23	26	50
	100	100	300316	2	2	42	25	26	65
	350	350	300317	1/4	1/8	17	11	10	14
	250	250	300318	3/8	1/4	18	12	14,5	17
	225	225	300319	1/2	3/8	21	14	14,5	22
	200	200	300320	3/4	1/2	25	16	19	27
160	160	300321	1	3/4	29	19	19	36	

Notes: If you wish to order a fitting in stainless steel, please change the first two digit from **30....** to **31....** .

MALE STUD STRAIGHT ADAPTER

Thread BSP Parallel/NPT

Type: **3004..**

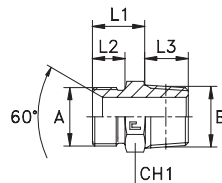

Series BS	30.... [bar]	31.... [bar]	Ordering Complete	A	B	L1	L2	L3	CH1
UNIVERSAL	350	350	300401	1/8	1/8	13	8	10	12
			300402	1/8	1/4	14	8	14,5	14
			300403	1/4	1/4	17	11	14,5	14
	250	250	300404	1/4	3/8	17	11	14,5	17
			300405	3/8	3/8	18	12	14,5	17
	225	225	300406	3/8	1/2	19	12	19	22
			300407	1/2	1/2	21	14	19	22
	200	200	300408	1/2	3/4	23	14	19	27
			300409	3/4	3/4	25	16	19	27
			300410	3/4	1	26	16	24	36
	160	160	300411	1	1	29	19	24	36
			300412	1	1/4	31	19	25	46
			300413	1 1/4	1/4	32	20	25	46
			300414	1 1/4	1/2	34	20	26	50
			300415	1 1/2	1/2	37	23	26	50
	100	100	300416	2	2	42	25	26	65
	350	350	300417	1/4	1/8	17	11	10	14
	250	250	300418	3/8	1/4	18	12	14,5	17
	225	225	300419	1/2	3/8	21	14	14,5	22
	200	200	300420	3/4	1/2	25	16	19	27
160	160	300421	1	3/4	29	19	19	36	

Notes: If you wish to order a fitting in stainless steel, please change the first two digit from **30....** to **31....** .

STRAIGHT BS5200/DIN 3852 ADAPTOR

Thread BSP Parallel

Type: 3005..

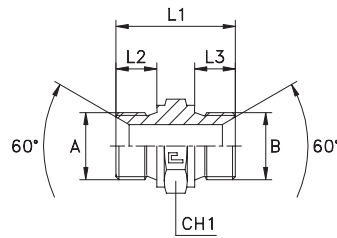

Series BS	30.... [bar]	31.... [bar]	Ordering Complete	A	B	L1	L2	L3	CH1
UNIVERSAL	400	400	300501	1/8	1/8	24	8	8	14
			300502	1/8	1/4	28,5	8	11	19
			300503	1/8	3/8	30	8	12	22
			300504	1/4	1/4	32	11	11	19
			300505	1/4	3/8	33,5	11	12	22
	350	350	300506	1/4	1/2	37	11	14	27
	315	315	300507	1/4	3/4	41	11	16	32
	400	400	300508	3/8	3/8	35	12	12	22
	350	350	300509	3/8	1/2	38,5	12	14	27
	315	315	300510	3/8	3/4	42,5	12	16	32
	350	350	300511	1/2	1/2	41	14	14	27
			300512	1/2	5/8	43	14	16	30
	315	315	300513	1/2	3/4	45	14	16	32
	250	250	300514	1/2	1	49	14	19	41
	200	200	300515	1/2	1 1/4	52	14	20	50
	350	350	300516	5/8	5/8	45	16	16	30
	315	315	300517	5/8	3/4	47	16	16	32
			300518	3/4	3/4	47	16	16	32
	250	250	300519	3/4	1	51	16	19	41
	200	200	300520	3/4	1 1/4	54	16	20	50
	160	160	300521	3/4	1 1/2	59	16	23	55
	250	250	300522	1	1	54	19	19	41
	200	200	300523	1	1 1/4	57	19	20	50
	160	160	300524	1	1 1/2	62	19	23	55
	125	125	300525	1	2	67,5	19	25	70
	200	200	300526	1 1/4	1 1/4	58	20	20	50
	160	160	300527	1 1/4	1 1/2	63	20	23	55
	125	125	300528	1 1/4	2	68,5	20	25	70
	160	160	300529	1 1/2	1 1/2	66	23	23	55
	125	125	300530	1 1/2	2	71,5	23	25	70
			300531	2	2	74	25	25	70
	350	350	300532	1/8	1/2	33,5	8	14	27
			300533	1/4	5/8	39	11	16	30
	250	250	300534	1/4	1	45	11	19	41
	350	350	300535	3/8	5/8	40,5	12	16	30
	250	250	300536	3/8	1	46,5	12	19	41
	160	160	300537	1/2	1 1/2	57	14	23	55
	250	250	300538	5/8	1	51	16	19	41
	200	200	300539	5/8	1 1/4	54	16	20	50

Notes: If you wish to order a fitting in stainless steel, please change the first two digit from 30.... to 31....
For copper washer sealing systems refer to items 3001.. pressure rates

STRAIGHT ISO 8434/6 COMPACT ADAPTOR TABLE 10 FIG. 9

Thread BSP Parallel

Type: 3005..

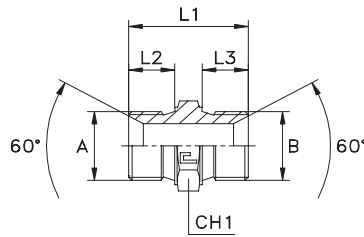

Serie BS	30.... [bar]	31.... [bar]	Ordering Complete	A	B	L1	L2	L3	CH1
UNIVERSAL	400	400	300551	1/8	1/8	21	8	8	12
			300552	1/8	1/4	27	8	11	17
			300553	1/8	3/8	29	8	12	19
			300554	1/4	1/4	28,5	11	11	17
			300555	1/4	3/8	30,5	11	12	19
	350	350	300556	1/4	1/2	34,5	11	14	24
	315	315	300557	1/4	3/4	37,5	11	16	30
	400	400	300558	3/8	3/8	32	12	12	19
	350	350	300559	3/8	1/2	36	12	14	24
	315	315	300560	3/8	3/4	39	12	16	30
	350	350	300561	1/2	1/2	37	14	14	24
			300562	1/2	5/8	39,5	14	16	27
	315	315	300563	1/2	3/4	40,5	14	16	30
	250	250	300564	1/2	1	44,5	14	19	36
	200	200	300565	1/2	1 1/4	50	14	20	46
	350	350	300566	5/8	5/8	43	16	16	27
	315	315	300567	5/8	3/4	44	16	16	30
			300568	3/4	3/4	42,5	16	16	30
	250	250	300569	3/4	1	46,5	16	19	36
	200	200	300570	3/4	1 1/4	52	16	20	46
	160	160	300571	3/4	1 1/2	55,5	16	22	50
	250	250	300572	1	1	49	19	19	36
	200	200	300573	1	1 1/4	55	19	20	46
	160	160	300574	1	1 1/2	58,5	19	22	50
	125	125	300575	1	2	63,5	19	25	65
	200	200	300576	1 1/4	1 1/4	56	20	20	46
	160	160	300577	1 1/4	1 1/2	59,5	20	22	50
	125	125	300578	1 1/4	2	65	20	25	65
	160	160	300579	1 1/2	1 1/2	61,5	22	22	50
			300580	1 1/2	2	67,5	22	25	65
	125	125	300581	2	2	70	25	25	65
			300582	1/8	1/2	33	8	14	24
	350	350	300583	1/4	5/8	37,5	11	16	27
	250	250	300584	1/4	1	42	11	19	36
	350	350	300585	3/8	5/8	38,5	12	16	27
	250	250	300586	3/8	1	43,5	12	19	36
	160	160	300587	1/2	1 1/2	53,5	14	22	50
	250	250	300588	5/8	1	48,5	16	19	36
	200	200	300589	5/8	1 1/4	54	16	20	46

Notes: If you wish to order a fitting in stainless steel, please change the first two digit from 30.... to 31....
For copper washer sealing systems refer to items 3001.. pressure rates

MALE BULKHEAD ADAPTOR230

Thread BSP Parallel

Type: **3005..-ATT**

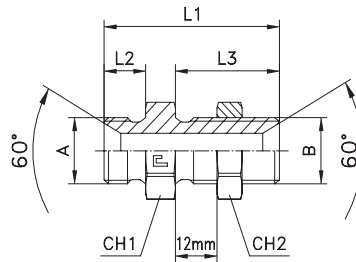

Series BS	30.... [bar]	31.... [bar]	Ordering Complete	A	B	L1	L2	L3	CH1	CH1
UNIVERSAL	400	400	300501-ATT	1/8	1/8	41	8	28	14	14
			300504-ATT	1/4	1/4	46	11	28	19	19
			300508-ATT	3/8	3/8	52	12	32	22	22
	350	350	300511-ATT	1/2	1/2	59	14	35	27	27
	315	315	300518-ATT	3/4	3/4	66	16	38	32	32
	250	250	300522-ATT	1	1	75	19	41	41	41
	200	200	300526-ATT	1 1/4	1 1/4	83	20	44	50	50
	160	160	300529-ATT	1 1/2	1 1/2	93	22	48	55	55
	125	125	300531-ATT	2	2	102	25	48	70	70

Notes: If you wish to order a fitting in stainless steel, please change the first two digit from **30....** to **31....** .
Articles available on scheduled orders only.
For copper washer sealing systems refer to items **3001..** pressure rates

MALE STRAIGHT ADAPTER

Thread Metric Parallel

Type: **3006..**

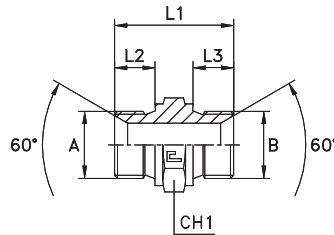

Series BS	30.... [bar]	31.... [bar]	Ordering Complete	A	B	L1	L2	L3	CH1
UNIVERSAL	400	400	300601	10x1	10x1	24	8	8	14
			300602	12x1,5	12x1,5	34	12	12	17
			300603	12x1,5	14x1,5	34	12	12	19
			300604	14x1,5	14x1,5	34	12	12	19
			300605	14x1,5	16x1,5	34	12	12	22
			300606	14x1,5	18x1,5	35,5	12	12	24
	350	350	300607	14x1,5	22x1,5	38	12	14	27
	400	400	300608	16x1,5	16x1,5	34	12	12	22
			300609	16x1,5	18x1,5	35,5	12	12	24
	350	350	300610	16x1,5	20x1,5	37,5	12	14	27
			300611	16x1,5	22x1,5	38	12	14	27
	400	400	300612	18x1,5	18x1,5	36	12	12	24
			300613	18x1,5	20x1,5	38	12	14	27
	350	350	300614	20x1,5	20x1,5	40,5	14	14	27
			300615	20x1,5	22x1,5	41	14	14	27
			300616	22x1,5	22x1,5	41	14	14	27
			300617	22x1,5	26x1,5	45	14	16	32
	315	315	300618	26x1,5	26x1,5	47	16	16	32
			300619	26x1,5	30x1,5	48	16	16	36
	250	250	300620	30x1,5	30x1,5	48	16	16	36
			300621	30x1,5	38x1,5	50	16	16	46
	200	200	300622	38x1,5	38x1,5	50	16	16	46
			300623	38x1,5	45x1,5	52	16	16	55
	160	160	300624	45x1,5	45x1,5	52	16	16	55

Notes: If you wish to order a fitting in stainless steel, please change the first two digit from **30....** to **31....** .
Articles available on scheduled orders only.
For copper washer sealing systems refer to items **3001..** pressure rates

MALE STRAIGHT ADAPTER

Thread BSP Parallel/metrico cilindrico

Type: **3007..**

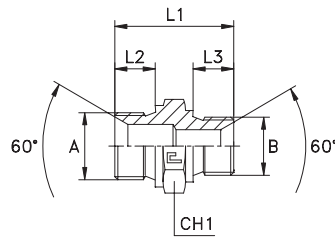

Series BS	30.... [bar]	31.... [bar]	Ordering Complete	A	B	L1	L2	L3	CH1
UNIVERSAL	400	400	300701	1/8	10x1	24	8	8	14
			300702	1/8	14x1,5	29,5	8	12	19
			300703	1/4	10x1	28,5	11	8	19
			300704	1/4	12x1,5	33	11	12	19
			300705	1/4	14x1,5	33	11	12	19
			300706	3/8	10x1	30	12	8	22
			300707	3/8	12x1,5	34,5	12	12	22
			300708	3/8	14x1,5	34,5	12	12	22
			300709	3/8	16x1,5	34,5	12	12	22
			300710	3/8	18x1,5	36	12	12	24
	350	350	300711	3/8	22x1,5	38,5	12	14	27
			300712	1/2	14x1,5	38	14	12	27
			300713	1/2	16x1,5	38	14	12	27
			300714	1/2	18x1,5	38,5	14	12	27
			300715	1/2	20x1,5	40,5	14	14	27
			300716	1/2	22x1,5	41	14	14	27
			300717	5/8	18x1,5	40,5	16	12	30
			300718	5/8	20x1,5	42,5	16	14	30
			300719	5/8	22x1,5	43	16	14	30
	315	315	300720	3/4	18x1,5	42,5	16	12	32
			300721	3/4	20x1,5	44,5	16	14	32
			300722	3/4	22x1,5	45	16	14	32
	250	250	300723	3/4	26x1,5	47	16	16	32
			300724	3/4	30x1,5	48	16	16	36
			300725	1	26x1,5	51	19	16	41
	200	200	300726	1	30x1,5	51	19	16	41
			300727	1	38x1,5	53	19	16	46
			300728	1 1/4	30x1,5	54	20	16	50
	160	160	300729	1 1/4	38x1,5	54	20	16	50
			300730	1 1/2	38x1,5	59	23	16	55
	125	125	300731	1 1/2	45x1,5	59	23	16	55
			300732	2	45x1,5	64,5	25	16	70

Notes: If you wish to order a fitting in stainless steel, please change the first two digit from **30....** to **31....** .
 Articles available on scheduled orders only.
 For copper washer sealing systems refer to items **3001..** pressure rates

MALE FEMALE STRAIGHT ADAPTER

Thread BSP Parallel

Type: **3008..**

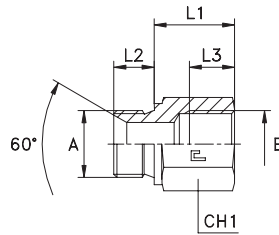

Series BS	30.... [bar]	31.... [bar]	Ordering Complete	A	B	L1	L2	L3	CH1
UNIVERSAL	350	350	300801	1/8	1/8	20	8	10	14
			300802	1/8	1/8	30	8	10	14
			300803	1/8	1/8	40	8	10	14
			300804	1/4	1/4	21	11	14	19
			300805	1/4	1/4	30	11	14	19
			300806	1/4	1/4	43	11	14	19
			300807	1/4	1/4	48	11	14	19
			300808	3/8	3/8	20	12	14	22
			300809	3/8	3/8	33	12	14	22
			300810	3/8	3/8	38	12	14	22
			300811	3/8	3/8	45	12	14	22
			300812	1/2	1/2	23	14	17	27
			300813	1/2	1/2	26	14	17	27
			300814	1/2	1/2	36	14	17	27
	300815	1/2	1/2	46	14	17	27		
	300816	1/2	1/2	66	14	17	27		
	300817	3/4	3/4	32	16	19	36		
	300818	3/4	3/4	40	16	19	36		
	300819	3/4	3/4	57	16	19	36		
	300820	1	1	35	19	21,5	41		
	300821	1	1	65	19	21,5	41		

Notes: If you wish to order a fitting in stainless steel, please change the first two digit from **30....** to **31....** .
For copper washer sealing systems refer to items **3001..** pressure rates.

MALE FEMALE STRAIGHT ADAPTER

Thread Metric Parallel

Type: **3009..**

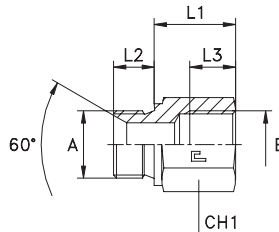

Series BS	30.... [bar]	31.... [bar]	Ordering Complete	A	B	L1	L2	L3	CH1
UNIVERSAL	350	350	300901	10x1	10x1	20	8	10	14
			300902	10x1	10x1	30	8	10	14
			300903	12x1,5	12x1,5	21	12	14,5	17
			300904	12x1,5	12x1,5	28	12	14,5	17
			300905	14x1,5	14x1,5	21	12	14,5	19
			300906	14x1,5	14x1,5	31	12	14,5	19
			300907	16x1,5	16x1,5	23	12	14,5	22
			300908	16x1,5	16x1,5	33	12	14,5	22
			300909	18x1,5	18x1,5	23	12	14,5	24
			300910	18x1,5	18x1,5	38	12	14,5	24
			300911	20x1,5	20x1,5	23	14	16,5	27
			300912	20x1,5	20x1,5	36	14	16,5	27
			300913	22x1,5	22x1,5	26	14	16,5	27
			300914	22x1,5	22x1,5	36	14	16,5	27
	300915	26x1,5	26x1,5	32	16	18,5	32		
	300916	26x1,5	26x1,5	44	16	18,5	32		
	300917	30x1,5	30x1,5	39	16	19	36		
	300918	30x1,5	30x1,5	69	16	19	36		

Notes: If you wish to order a fitting in stainless steel, please change the first two digit from **30....** to **31....** .
Articles available on request only.
For copper washer sealing systems refer to items **3001..** pressure rates.

PLUG WITH EXAGON SOCKET HEAD

Thread BSP Taper

Type: **3010..**

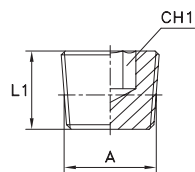

Series BS	30.... [bar]	31.... [bar]	Ordering Complete	A	L1	CH1
UNIVERSAL	350	350	301001	1/8	8	5
			301002	1/4	10	7
	250	250	301003	3/8	10	8
			301004	1/2	10	10
	200	200	301005	3/4	12	12
			301006	1	12	17
	160	160	301007	1 1/4	18	22
			301008	1 1/2	20	24

Notes: If you wish to order a fitting in stainless steel, please change the first two digit from **30....** to **31....** .

PLUG WITH EXAGON SOCKET HEAD

Thread NPT

Type: **3011..**

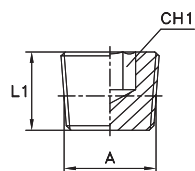

Series BS	30.... [bar]	31.... [bar]	Ordering Complete	A	L1	CH1
UNIVERSAL	350	350	301101	1/8	7,4	4,78
			301102	1/4	11,3	6,35
	250	250	301103	3/8	11,3	7,95
			301104	1/2	15	9,52
	200	200	301105	3/4	15,3	14,3
			301106	1	19	15,88
	160	160	301107	1 1/4	20,3	19,05
			301108	1 1/2	21	25,4

Notes: If you wish to order a fitting in stainless steel, please change the first two digit from **30....** to **31....** .

FEMALE STRAIGHT ADAPTER

Thread BSP Parallel

Type: **3012..**

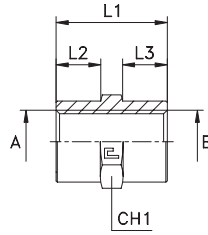

Series BS	30.... [bar]	31.... [bar]	Ordering Complete	A	B	L1	L2	L3	CH1
UNIVERSAL	350	350	301201	1/8	1/8	20	7	7	14
			301202	1/4	1/4	30	12	12	19
	250	250	301203	3/8	3/8	30	12	12	24
	225	225	301204	1/2	1/2	38	15	15	27
	200	200	301205	3/4	3/4	40	15	15	36
	160	160	301206	1	1	48	19	19	41
			301207	1 1/4	1 1/4	50	19	19	55
			301208	1 1/2	1 1/2	50	18	18	60
	350	350	301209	1/8	1/4	25	7	12	19
	250	250	301210	1/8	3/8	25	7	12	24
			301211	1/4	3/8	30	12	12	24
	225	225	301212	1/4	1/2	35	12	15	27
	200	200	301213	1/4	3/4	37	12	15	36
	225	225	301214	3/8	1/2	35	12	15	27
	200	200	301215	1/2	3/4	40	15	15	36

Notes: If you wish to order a fitting in stainless steel, please change the first two digit from **30....** to **31....** .

FEMALE STRAIGHT ADAPTER

Thread Metric Parallel

Type: **3013..**

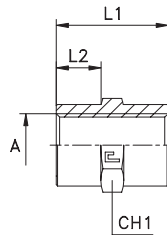

Series BS	30.... [bar]	31.... [bar]	Ordering Complete	A	L1	L2	CH1
UNIVERSAL	350	350	301301	10x1	20	7	14
			301302	14x1,5	30	12	19
	250	250	301303	16x1,5	30	12	24
	225	225	301304	22x1,5	38	15	27
	200	200	301305	27x2	40	15	36
	160	160	301306	33x2	48	19	41
			301307	42x2	50	19	55
			301308	48x2	50	18	60

Notes: If you wish to order a fitting in stainless steel, please change the first two digit from **30....** to **31....** .
Articles available on scheduled orders only.

FEMALE STRAIGHT ADAPTER

Thread BSP Taper

Type: **3014..**

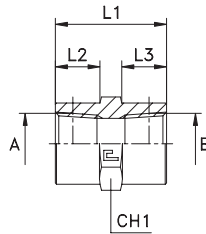

Series BS	30.... [bar]	31.... [bar]	Ordering Complete	A	B	L1	L2	L3	CH1
UNIVERSAL	350	350	301401	1/8	1/8	20	7	7	14
			301402	1/4	1/4	30	12	12	19
	250	250	301403	3/8	3/8	30	12	12	24
	225	225	301404	1/2	1/2	38	15	15	27
	200	200	301405	3/4	3/4	40	15	15	36
	160	160	301406	1	1	48	19	19	41
			301407	1 1/4	1 1/4	60	24	24	50
			301408	1 1/2	1 1/2	60	23	23	60
	350	350	301409	1/8	1/4	25	7	12	19
	250	250	301410	1/8	3/8	25	7	12	24
			301411	1/4	3/8	30	12	12	24
	225	225	301412	1/4	1/2	35	12	15	27
	200	200	301413	1/4	3/4	37	12	15	36
	225	225	301414	3/8	1/2	35	12	15	27
	200	200	301415	1/2	3/4	40	15	15	36

Notes: If you wish to order a fitting in stainless steel, please change the first two digit from **30....** to **31....** .
Articles available on scheduled orders only.

FEMALE STRAIGHT ADAPTER

Thread NPT

Type: **3015..**

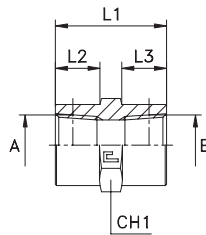

Series BS	30.... [bar]	31.... [bar]	Ordering Complete	A	B	L1	L2	L3	CH1
UNIVERSAL	350	350	301501	1/8	1/8	20	7	7	14
			301502	1/4	1/4	30	12	12	19
	250	250	301503	3/8	3/8	30	12	12	24
	225	225	301504	1/2	1/2	38	15	15	27
	200	200	301505	3/4	3/4	40	15	15	36
	160	160	301506	1	1	48	19	19	41
			301507	1 1/4	1 1/4	60	24	24	50
			301508	1 1/2	1 1/2	60	23	23	60
	350	350	301509	1/8	1/4	25	7	12	19
	250	250	301510	1/8	3/8	25	7	12	24
			301511	1/4	3/8	30	12	12	24
	225	225	301512	1/4	1/2	35	12	15	27
	200	200	301513	1/4	3/4	37	12	15	36
	225	225	301514	3/8	1/2	35	12	15	27
	200	200	301515	1/2	3/4	40	15	15	36

Notes: If you wish to order a fitting in stainless steel, please change the first two digit from **30....** to **31....** .
Articles available on scheduled orders only.

STRAIGHT ADAPTER WITH SWIVEL NUT

Thread BSP Parallel

Type: **3016..**

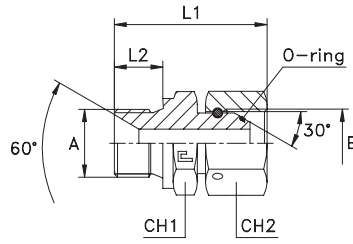

Series BS	30.... [bar]	31.... [bar]	Ordering Complete	A	B	L1	L2	CH1	CH2
UNIVERSAL	400	400	301601	1/8	1/8	28	8	14	14
			301602	1/4	1/4	36	11	19	19
			301603	3/8	3/8	39	12	22	22
	350	350	301604	1/2	1/2	45	14	27	27
			301605	5/8	5/8	51	16	30	30
	315	315	301606	3/4	3/4	53	16	32	32
	250	250	301607	1	1	63,5	19	41	41
	200	200	301608	1 1/4	1 1/4	67	20	50	50
	160	160	301609	1 1/2	1 1/2	77,5	23	55	55
	125	125	301610	2	2	87	25	70	70
	400	400	301611	1/4	3/8	37	11	19	22
			301612	3/8	1/4	38	12	22	19
	350	350	301613	3/8	1/2	42	12	22	27
			301614	1/2	1/4	41	14	27	19
			301615	1/2	3/8	42	14	27	22
	315	315	301616	1/2	3/4	49	14	27	32
			301617	3/4	1/2	49	16	32	27
	250	250	301618	1	3/4	57	19	41	32

Notes: If you wish to order a fitting in stainless steel, please change the first two digit from **30....** to **31....** .
For copper washer sealing systems refer to items **3001..** pressure rates.

STRAIGHT ADAPTER WITH SWIVEL NUT

Thread Metric Parallel

Type: **3017..**

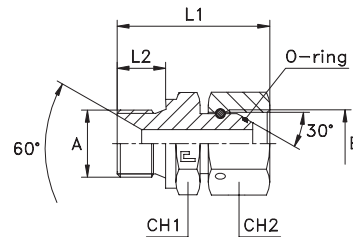

Series BS	30.... [bar]	31.... [bar]	Ordering Complete	A	B	L1	L2	CH1	CH2
UNIVERSAL	400	400	301701	12x1,5	12x1,5	35	12	17	17
			301702	14x1,5	14x1,5	37	12	19	19
			301703	16x1,5	16x1,5	38	12	22	22
			301704	18x1,5	18x1,5	41	12	24	24
	350	350	301705	20x1,5	20x1,5	46	14	27	27
			301706	22x1,5	22x1,5	47	14	27	27
	315	315	301707	26x1,5	26x1,5	53,5	16	32	32
	250	250	301708	30x1,5	30x1,5	56,5	16	36	36

Notes: If you wish to order a fitting in stainless steel, please change the first two digit from **30....** to **31....** .
Articles available on request only.
For copper washer sealing systems refer to items **3001..** pressure rates.

STRAIGHT ADAPTER WITH DOUBLE SWIVEL NUT

Thread BSP Parallel

Type: **3018..**

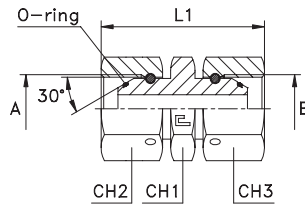

Series BS	30.... [bar]	31.... [bar]	Ordering Complete	A	B	L1	CH1	CH2	CH3
UNIVERSAL	400	400	301801	1/8	1/8	31,5	14	14	14
			301802	1/4	1/4	40,5	19	19	19
			301803	3/8	3/8	42,5	22	22	22
	350	350	301804	1/2	1/2	49,5	27	27	27
			301805	5/8	5/8	55	30	30	30
	315	315	301806	3/4	3/4	59	32	32	32
	250	250	301807	1	1	73	41	41	41
	200	200	301808	1 1/4	1 1/4	76	50	50	50
	160	160	301809	1 1/2	1 1/2	89	55	55	55
	125	125	301810	2	2	99	70	70	70
	400	400	301811	1/4	3/8	41,5	22	19	22
			301812	1/4	1/2	45,5	27	19	27
	350	350	301813	3/8	1/2	46	27	22	27
			301814	1/2	3/4	55	32	27	32

Notes: If you wish to order a fitting in stainless steel, please change the first two digit from **30....** to **31....** .

STRAIGHT ADAPTER WITH DOUBLE SWIVEL NUT

Thread Metric Parallel

Type: **3019..**

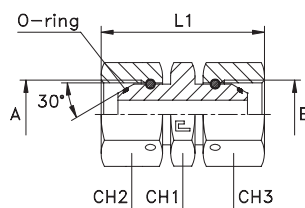

Series BS	30.... [bar]	31.... [bar]	Ordering Complete	A	L1	CH1	CH2
UNIVERSAL	400	400	301901	12x1,5	36	17	17
			301902	14x1,5	40,5	19	19
			301903	16x1,5	42	22	22
			301904	18x1,5	45	24	24
	350	350	301905	20x1,5	51,5	27	27
			301906	22x1,5	53	27	27
	315	315	301907	26x1,5	59,5	32	32
	250	250	301908	30x1,5	64	36	36

Notes: If you wish to order a fitting in stainless steel, please change the first two digit from **30....** to **31....** .
Articles available on request only.

MALE 90° ADAPTER

Thread BSP Taper

Type: **3020..**

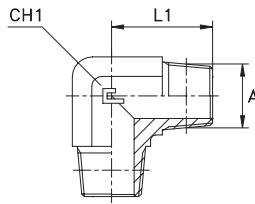

Series BS	30.... [bar]	31.... [bar]	Ordering Complete	A	L1	CH1
UNIVERSAL	350	350	302001	1/8	20	11
			302002	1/4	28	14
	250	250	302003	3/8	31	19
	225	225	302004	1/2	37,5	22
	200	200	302005	3/4	40	27
	160	160	302006	1	50	33
			302007	1 1/4	60	41
			302008	1 1/2	67	48
	100	100	302009	2	76	65

Notes: If you wish to order a fitting in stainless steel, please change the first two digit from **30....** to **31....** .

MALE 90° ADAPTER

Thread NPT

Type: **3021..**

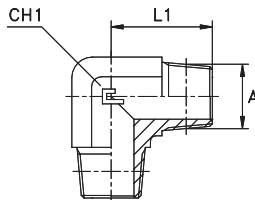

Series BS	30.... [bar]	31.... [bar]	Ordering Complete	A	L1	CH1
UNIVERSAL	350	350	302101	1/8	20	11
			302102	1/4	28	14
	250	250	302103	3/8	31	19
	225	225	302104	1/2	37,5	22
	200	200	302105	3/4	40	27
	160	160	302106	1	50	33
			302107	1 1/4	60	41
			302108	1 1/2	67	48
	100	100	302109	2	76	65

Notes: If you wish to order a fitting in stainless steel, please change the first two digit from **30....** to **31....** .
Articles available on request only.

MALE STUD 90° ADAPTER

Thread BSP Parallel/BSP Taper

Type: **3022..**

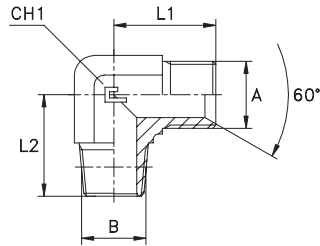

Series BS	30.... [bar]	31.... [bar]	Ordering Complete	A	B	L1	L2	CH1
UNIVERSAL	350	350	302201	1/8	1/8	21	20	11
			302202	1/4	1/4	26	28	14
	250	250	302203	3/8	3/8	29	31	19
			302204	1/2	1/2	34	37,5	22
	200	200	302205	5/8	1/2	38	40	27
			302206	3/4	3/4	41	40	27
	160	160	302207	1	1	45	50	33
			302208	1 1/4	1 1/4	52	60	41
			302209	1 1/2	1 1/2	59	67	48
	100	100	302210	2	2	78	76	65

Notes: If you wish to order a fitting in stainless steel, please change the first two digit from **30....** to **31....** .

MALE STUD 90° ADAPTER

Thread BSP Parallel/NPT

Type: **3023..**

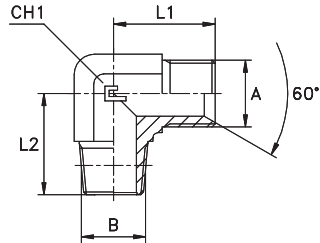

Series BS	30.... [bar]	31.... [bar]	Ordering Complete	A	B	L1	L2	CH1
UNIVERSAL	350	350	302301	1/8	1/8	21	20	11
			302302	1/4	1/4	26	28	14
	250	250	302303	3/8	3/8	29	31	19
			302304	1/2	1/2	34	37,5	22
	200	200	302305	5/8	1/2	38	40	27
			302306	3/4	3/4	41	40	27
	160	160	302307	1	1	45	50	33
			302308	1 1/4	1 1/4	52	60	41
			302309	1 1/2	1 1/2	59	67	48
	100	100	302310	2	2	78	76	65

Notes: If you wish to order a fitting in stainless steel, please change the first two digit from **30....** to **31....** .
Articles available on request only.

MALE 90° UNION ELBOW ADAPTER

Thread BSP Parallel

Type: **3024..**

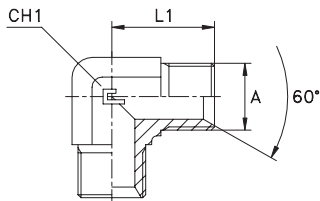

Series BS	30.... [bar]	31.... [bar]	Ordering Complete	A	L1	CH1
UNIVERSAL	400	400	302401	1/8	21	11
			302402	1/4	26	14
			302403	3/8	29	19
	350	350	302404	1/2	34	22
			302405	5/8	38	27
	315	315	302406	3/4	41	27
	250	250	302407	1	45	33
	200	200	302408	1 1/4	52	41
	160	160	302409	1 1/2	59	48
125	125	302410	2	78	65	

Notes: If you wish to order a fitting in stainless steel, please change the first two digit from **30....** to **31....** .

MALE 90° UNION ELBOW ADAPTER

Thread Metric Parallel

Type: **3025..**

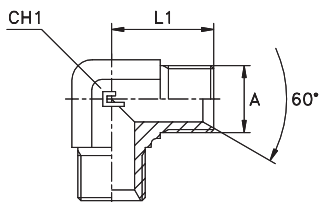

Series BS	30.... [bar]	31.... [bar]	Ordering Complete	A	L1	CH1
UNIVERSAL	400	400	302501	10x1	21	11
			302502	12x1,5	21	11
			302503	14x1,5	26	14
			302504	16x1,5	29	19
			302505	18x1,5	29	19
	350	350	302506	20x1,5	34	22
			302507	22x1,5	34	22
	315	315	302508	26x1,5	41	27
	250	250	302509	30x1,5	45	33

Notes: If you wish to order a fitting in stainless steel, please change the first two digit from **30....** to **31....** .
Articles available on request only.

MALE STUD 45° ADAPTER

Thread BSP Parallel/BSP Taper

Type: **3026..**

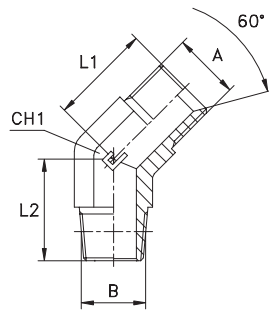

Series BS	30.... [bar]	31.... [bar]	Ordering Complete	A	B	L1	L2	CH1
UNIVERSAL	350	350	302601	1/8	1/8	20,5	16,5	11
			302602	1/4	1/4	21	22	14
	250	250	302603	3/8	3/8	23,5	24	19
			302604	1/2	1/2	26	29,5	22
	200	200	302605	5/8	1/2	29	30,5	27
			302606	3/4	3/4	32	30,5	27
	160	160	302607	1	1	37	38	33
			302608	1 1/4	1 1/4	39	42	41
			302609	1 1/2	1 1/2	46	45	48
	100	100	302610	2	2	57	54	65

Notes: If you wish to order a fitting in stainless steel, please change the first two digit from **30....** to **31....** .
Articles available on scheduled orders only.

MALE STUD 45° ADAPTER

Thread BSP Parallel/NPT

Type: **3027..**

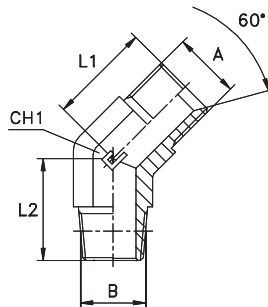

Series BS	30.... [bar]	31.... [bar]	Ordering Complete	A	B	L1	L2	CH1
UNIVERSAL	350	350	302701	1/8	1/8	20,5	16,5	11
			302702	1/4	1/4	21	22	14
	250	250	302703	3/8	3/8	23,5	24	19
			302704	1/2	1/2	26	29,5	22
	200	200	302705	5/8	1/2	29	30,5	27
			302706	3/4	3/4	32	30,5	27
	160	160	302707	1	1	37	38	33
			302708	1 1/4	1 1/4	39	42	41
			302709	1 1/2	1 1/2	46	45	48
	100	100	302710	2	2	57	54	65

Notes: If you wish to order a fitting in stainless steel, please change the first two digit from **30....** to **31....** .
Articles available on request only.

MALE 45° UNION ELBOW ADAPTER

Thread BSP Parallel

Type: **3028..**

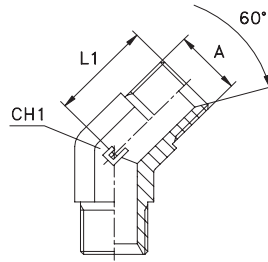

Series BS	30.... [bar]	31.... [bar]	Ordering Complete	A	L1	CH1
UNIVERSAL	400	400	302801	1/8	20,5	11
			302802	1/4	21	14
			302803	3/8	23,5	19
	350	350	302804	1/2	26	22
			302805	5/8	29	27
	315	315	302806	3/4	32	27
	250	250	302807	1	37	33
	200	200	302808	1 1/4	39	41
	160	160	302809	1 1/2	46	48
	125	125	302810	2	57	65

Notes: If you wish to order a fitting in stainless steel, please change the first two digit from **30....** to **31....** .
Articles available on scheduled orders only.

MALE 45° UNION ELBOW ADAPTER

Thread Metric Parallel

Type: **3029..**

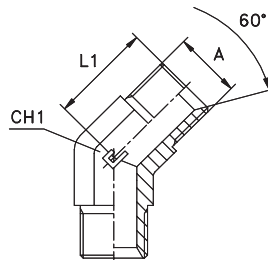

Series BS	30.... [bar]	31.... [bar]	Ordering Complete	A	L1	CH1
UNIVERSAL	400	400	302901	12x1,5	18	11
			302902	14x1,5	21	14
			302903	16x1,5	25	19
			302904	18x1,5	28	19
	350	350	302905	20x1,5	30	22
			302906	22x1,5	30	22
	315	315	302907	26x1,5	33	27
	250	250	302908	30x1,5	37	33

Notes: If you wish to order a fitting in stainless steel, please change the first two digit from **30....** to **31....** .
Articles available on request only.

MALE STUD BARREL TEE ADAPTER

Thread BSP Parallel/BSP Taper

Type: **3030..**

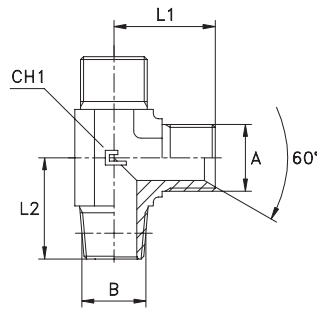

Series BS	30.... [bar]	31.... [bar]	Ordering Complete	A	B	L1	L2	CH1
UNIVERSAL	350	350	303001	1/8	1/8	21	20	11
			303002	1/4	1/4	26	28	14
	250	250	303003	3/8	3/8	29	31	19
			303004	1/2	1/2	34	37,5	22
	200	200	303005	5/8	1/2	38	40	27
			303006	3/4	3/4	41	40	27
	160	160	303007	1	1	45	50	33
			303008	1 1/4	1 1/4	52	60	41
			303009	1 1/2	1 1/2	59	67	48
	100	100	303010	2	2	78	76	65

Notes: If you wish to order a fitting in stainless steel, please change the first two digit from **30....** to **31....** .
Articles available on request only.

MALE STUD BARREL TEE ADAPTER

Thread BSP Parallel/NPT

Type: **3031..**

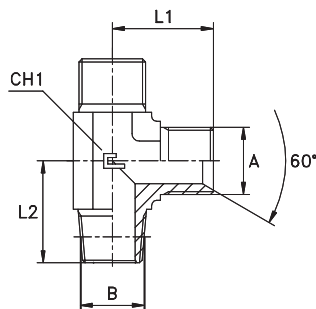

Series BS	30.... [bar]	31.... [bar]	Ordering Complete	A	B	L1	L2	CH1
UNIVERSAL	350	350	303101	1/8	1/8	21	20	11
			303102	1/4	1/4	26	28	14
	250	250	303103	3/8	3/8	29	31	19
			303104	1/2	1/2	34	37,5	22
	200	200	303105	5/8	1/2	38	40	27
			303106	3/4	3/4	41	40	27
	160	160	303107	1	1	45	50	33
			303108	1 1/4	1 1/4	52	60	41
			303109	1 1/2	1 1/2	59	67	48
	100	100	303110	2	2	78	76	65

Notes: If you wish to order a fitting in stainless steel, please change the first two digit from **30....** to **31....** .
Articles available on request only.

MALE STUD BRANCH TEE ADAPTER

Thread BSP Parallel/BSP Taper

Type: **3032..**

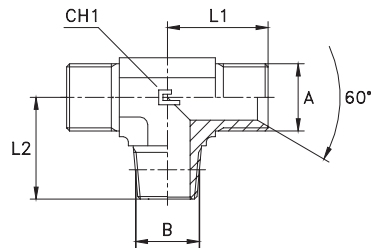

Series BS	30.... [bar]	31.... [bar]	Ordering Complete	A	B	L1	L2	CH1
UNIVERSAL	350	350	303201	1/8	1/8	21	20	11
			303202	1/4	1/4	26	28	14
	250	250	303203	3/8	3/8	29	31	19
			303204	1/2	1/2	34	37,5	22
	200	200	303205	5/8	1/2	38	40	27
			303206	3/4	3/4	41	40	27
			303207	1	1	45	50	33
	160	160	303208	1 1/4	1 1/4	52	60	41
			303209	1 1/2	1 1/2	59	67	48
	100	100	303210	2	2	78	76	65

Notes: If you wish to order a fitting in stainless steel, please change the first two digit from **30....** to **31....** .
Articles available on request only.

MALE STUD BRANCH TEE ADAPTER

Thread BSP Parallel/NPT

Type: **3033..**

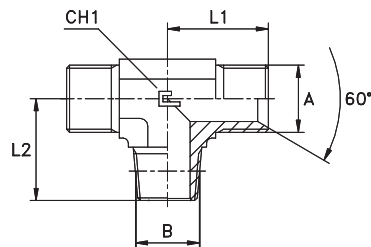

Series BS	30.... [bar]	31.... [bar]	Ordering Complete	A	B	L1	L2	CH1
UNIVERSAL	350	350	303301	1/8	1/8	21	20	11
			303302	1/4	1/4	26	28	14
	250	250	303303	3/8	3/8	29	31	19
			303304	1/2	1/2	34	37,5	22
	200	200	303305	5/8	1/2	38	40	27
			303306	3/4	3/4	41	40	27
			303307	1	1	45	50	33
	160	160	303308	1 1/4	1 1/4	52	60	41
			303309	1 1/2	1 1/2	59	67	48
	100	100	303310	2	2	78	76	65

Notes: If you wish to order a fitting in stainless steel, please change the first two digit from **30....** to **31....** .
Articles available on request only.

MALE EQUAL TEE ADAPTER

Thread BSP Parallel

Type: **3034..**

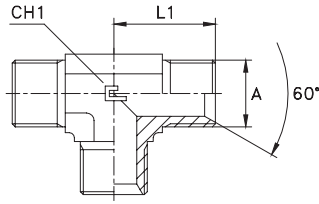

Series BS	30.... [bar]	31.... [bar]	Ordering Complete	A	L1	CH1
UNIVERSAL	400	400	303401	1/8	21	11
			303402	1/4	26	14
			303403	3/8	29	19
	350	350	303404	1/2	34	22
			303405	5/8	38	27
	315	315	303406	3/4	41	27
	250	250	303407	1	45	33
	200	200	303408	1 1/4	52	41
	160	160	303409	1 1/2	59	48
	125	125	303410	2	78	65

Notes: If you wish to order a fitting in stainless steel, please change the first two digit from **30....** to **31....** .

MALE EQUAL TEE ADAPTER

Thread Metric Parallel

Type: **3035..**

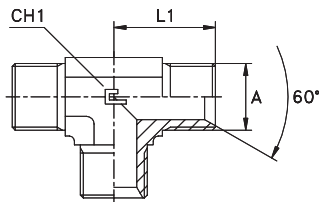

Series BS	30.... [bar]	31.... [bar]	Ordering Complete	A	L1	CH1
UNIVERSAL	400	400	303501	10x1	21	11
			303502	12x1,5	21	11
			303503	14x1,5	26	14
			303504	16x1,5	29	19
			303505	18x1,5	29	19
	350	350	303506	20x1,5	34	22
			303507	22x1,5	34	22
	315	315	303508	26x1,5	41	27
	250	250	303509	30x1,5	45	33

Notes: If you wish to order a fitting in stainless steel, please change the first two digit from **30....** to **31....** .
Articles available on request only.

MALE STUD EQUAL CROSS ADAPTER

Thread BSP Parallel

Type: **3036..**

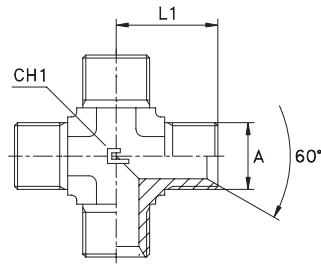

Series BS	30.... [bar]	31.... [bar]	Ordering Complete	A	L1	CH1
UNIVERSAL	400	400	303601	1/8	21	11
			303602	1/4	26	14
			303603	3/8	29	19
	350	350	303604	1/2	34	22
			303605	5/8	38	27
	315	315	303606	3/4	41	27
	250	250	303607	1	45	33
	200	200	303608	1 1/4	52	41
	160	160	303609	1 1/2	59	48
	125	125	303610	2	78	65

Notes: If you wish to order a fitting in stainless steel, please change the first two digit from **30....** to **31....** .
Articles available on scheduled orders only.

MALE STUD EQUAL CROSS ADAPTER

Thread BSP Parallel/NPT

Type: **3037..**

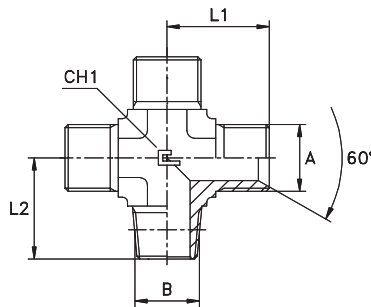

Series BS	30.... [bar]	31.... [bar]	Ordering Complete	A	B	L1	L2	CH1
UNIVERSAL	350	350	303701	1/8	1/8	21	20	11
			303702	1/4	1/4	26	28	14
	250	250	303703	3/8	3/8	29	31	19
	225	225	303704	1/2	1/2	34	37,5	22
	200	200	303705	5/8	1/2	38	40	27
			303706	3/4	3/4	41	40	27
	160	160	303707	1	1	45	50	33
			303708	1 1/4	1 1/4	52	60	41
			303709	1 1/2	1 1/2	59	67	48
	100	100	303710	2	2	78	76	65

Notes: If you wish to order a fitting in stainless steel, please change the first two digit from **30....** to **31....** .
Articles available on request only.

MALE / FEMALE STUD 90° ADAPTER

Thread BSP Parallel/BSP Taper

Type: **3038..**

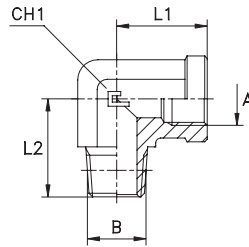

Series BS	30.... [bar]	31.... [bar]	Ordering Complete	A	B	L1	L2	CH1
UNIVERSAL	350	350	303801	1/8	1/8	17	20	14
			303802	1/4	1/4	22,5	28	19
	250	250	303803	3/8	3/8	26	31	22
	225	225	303804	1/2	1/2	31	37,5	27
	200	200	303805	3/4	3/4	34,5	40	33
	160	160	303806	1	1	41	50	41
			303807	1 1/4	1 1/4	43	60	48
			303808	1 1/2	1 1/2	53	67	65
	100	100	303809	2	2	61	76	71

Notes: If you wish to order a fitting in stainless steel, please change the first two digit from **30....** to **31....** .
Articles available on scheduled orders only.

MALE / FEMALE STUD 90° ADAPTER

Thread NPT

Type: **3039..**

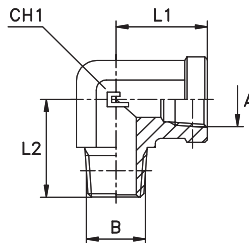

Series BS	30.... [bar]	31.... [bar]	Ordering Complete	A	B	L1	L2	CH1
UNIVERSAL	350	350	303901	1/8	1/8	17	20	14
			303902	1/4	1/4	22,5	28	19
	250	250	303903	3/8	3/8	26	31	22
	225	225	303904	1/2	1/2	31	37,5	27
	200	200	303905	3/4	3/4	34,5	40	33
	160	160	303906	1	1	41	50	41
			303907	1 1/4	1 1/4	43	60	48
			303908	1 1/2	1 1/2	53	67	65
	100	100	303909	2	2	61	76	71

Notes: If you wish to order a fitting in stainless steel, please change the first two digit from **30....** to **31....** .
Articles available on scheduled orders only.

MALE / FEMALE STUD 45° ADAPTER

Thread BSP Parallel/BSP Taper

Type: **3040..**

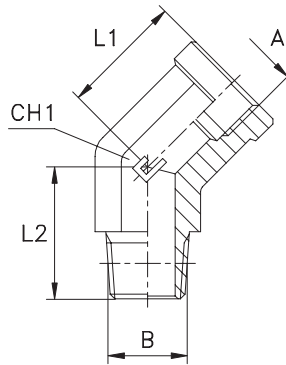

Series BS	30.... [bar]	31.... [bar]	Ordering Complete	A	B	L1	L2	CH1
UNIVERSAL	350	350	304001	1/8	1/8	15,5	18	14
			304002	1/4	1/4	21	26,5	19
	250	250	304003	3/8	3/8	22	27	22
			304004	1/2	1/2	26	34	27
	200	200	304005	3/4	3/4	29,5	35	33
			304006	1	1	33	44	41
	160	160	304007	1 1/4	1 1/4	39	45,5	48
			304008	1 1/2	1 1/2	43	53	65
	100	100	304009	2	2	55	57	71

Notes: If you wish to order a fitting in stainless steel, please change the first two digit from **30....** to **31....** .
Articles available on scheduled orders only.

MALE / FEMALE STUD 45° ADAPTER

Thread NPT

Type: **3041..**

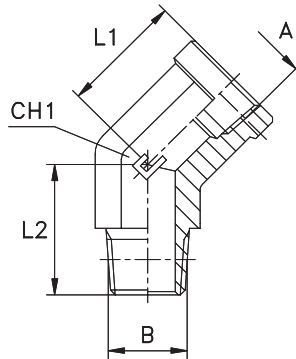

Series BS	30.... [bar]	31.... [bar]	Ordering Complete	A	B	L1	L2	CH1
UNIVERSAL	350	350	304101	1/8	1/8	13	18	14
			304102	1/4	1/4	18	26,5	19
	250	250	304103	3/8	3/8	19,5	27	22
			304104	1/2	1/2	24,5	25	27
	200	200	304105	3/4	3/4	26	35	33
			304106	1	1	31	44	41
	160	160	304107	1 1/4	1 1/4	37	45,5	48
			304108	1 1/2	1 1/2	43	53	65
	100	100	304109	2	2	55	57	71

Notes: If you wish to order a fitting in stainless steel, please change the first two digit from **30....** to **31....** .
Articles available on scheduled orders only.

FEMALE 90° ADAPTER

Thread BSP Parallel

Type: **3042..**

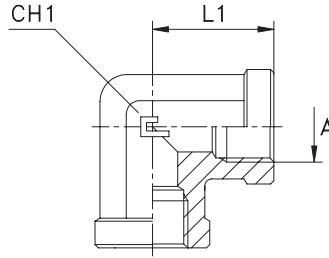

Series BS	30.... [bar]	31.... [bar]	Ordering Complete	A	L1	CH1
UNIVERSAL	350	350	304201	1/8	17	14
			304202	1/4	22,5	19
	250	250	304203	3/8	26	22
			304204	1/2	31	27
	200	200	304205	3/4	34,5	33
			304206	1	41	41
	160	160	304207	1 1/4	43	48
			304208	1 1/2	53	65
			304209	2	61	71
	100	100				

Notes: If you wish to order a fitting in stainless steel, please change the first two digit from **30....** to **31....** .

FEMALE 90° ADAPTER

Thread NPT

Type: **3043**

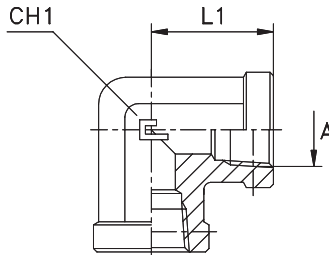

Series BS	30.... [bar]	31.... [bar]	Ordering Complete	A	L1	CH1
UNIVERSAL	350	350	304301	1/8	17	14
			304302	1/4	22,5	19
	250	250	304303	3/8	26	22
			304304	1/2	31	27
	200	200	304305	3/4	34,5	33
			304306	1	41	41
	160	160	304307	1 1/4	43	48
			304308	1 1/2	53	65
			304309	2	61	71
	100	100				

Notes: If you wish to order a fitting in stainless steel, please change the first two digit from **30....** to **31....** .
Articles available on scheduled orders only.

FEMALE 45° ADAPTER

Thread BSP Parallel

Type: **3044..**

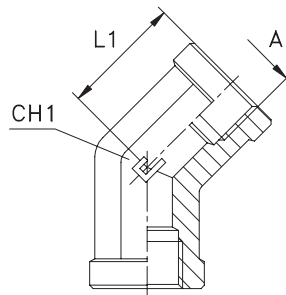

Series BS	30.... [bar]	31.... [bar]	Ordering Complete	A	L1	CH1
UNIVERSAL	350	350	304401	1/8	15,5	14
			304402	1/4	21	19
	250	250	304403	3/8	22	22
	225	225	304404	1/2	26	27
	200	200	304405	3/4	29,5	33
	160	160	304406	1	33	41
			304407	1 1/4	39	48
			304408	1 1/2	43	65
	100	100	304409	2	55	71

Notes: If you wish to order a fitting in stainless steel, please change the first two digit from **30....** to **31....** .
Articles available on scheduled orders only.

FEMALE 45° ADAPTER

Thread NPT

Type: **3045..**

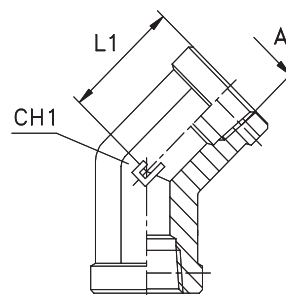

Series BS	30.... [bar]	31.... [bar]	Ordering Complete	A	L1	CH1
UNIVERSAL	350	350	304501	1/8	13	14
			304502	1/4	18	19
	250	250	304503	3/8	19,5	22
	225	225	304504	1/2	24,5	27
	200	200	304505	3/4	26	33
	160	160	304506	1	31	41
			304507	1 1/4	37	48
			304508	1 1/2	43	65
	100	100	304509	2	55	71

Notes: If you wish to order a fitting in stainless steel, please change the first two digit from **30....** to **31....** .
Articles available on scheduled orders only.

FEMALE STUD BARREL TEE ADAPTER

Thread BSP Parallel/BSP Taper

Type: **3046..**

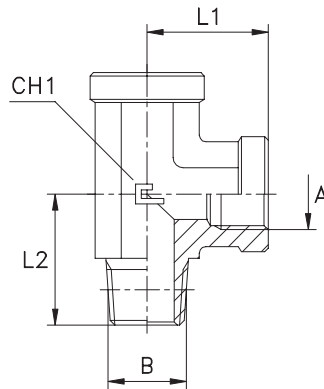

Series BS	30.... [bar]	31.... [bar]	Ordering Complete	A	B	L1	L2	CH1
UNIVERSAL	350	350	304601	1/8	1/8	17	20	14
			304602	1/4	1/4	22,5	28	19
	250	250	304603	3/8	3/8	26	31	22
	225	225	304604	1/2	1/2	31	37,5	27
	200	200	304605	3/4	3/4	34,5	40	33
	160	160	304606	1	1	41	50	41
			304607	1 1/4	1 1/4	43	60	48
			304608	1 1/2	1 1/2	53	67	65
	100	100	304609	2	2	61	76	71

Notes: If you wish to order a fitting in stainless steel, please change the first two digit from **30....** to **31....** .
Articles available on request only.

FEMALE STUD BARREL TEE ADAPTER

Thread NPT

Type: **3047..**

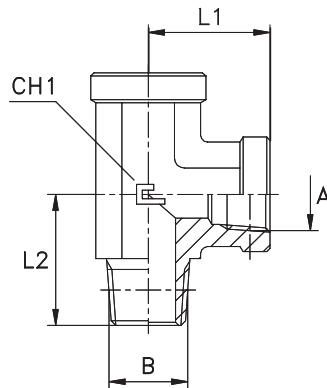

Series BS	30.... [bar]	31.... [bar]	Ordering Complete	A	B	L1	L2	CH1
UNIVERSAL	350	350	304701	1/8	1/8	17	20	14
			304702	1/4	1/4	22,5	28	19
	250	250	304703	3/8	3/8	26	31	22
	225	225	304704	1/2	1/2	31	37,5	27
	200	200	304705	3/4	3/4	34,5	40	33
	160	160	304706	1	1	41	50	41
			304707	1 1/4	1 1/4	43	60	48
			304708	1 1/2	1 1/2	53	67	65
	100	100	304709	2	2	61	76	71

Notes: If you wish to order a fitting in stainless steel, please change the first two digit from **30....** to **31....** .
Articles available on request only.

FEMALE STUD BRANCH TEE ADAPTER

Thread BSP Parallel/BSP Taper

Type: **3048..**

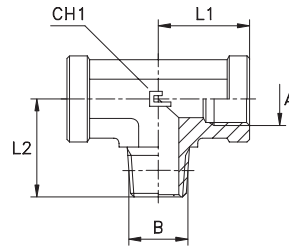

Series BS	30.... [bar]	31.... [bar]	Ordering Complete	A	B	L1	L2	CH1
UNIVERSAL	350	350	304801	1/8	1/8	17	20	14
			304802	1/4	1/4	22,5	28	19
	250	250	304803	3/8	3/8	26	31	22
	225	225	304804	1/2	1/2	31	37,5	27
	200	200	304805	3/4	3/4	34,5	40	33
	160	160	304806	1	1	41	50	41
			304807	1 1/4	1 1/4	43	60	48
			304808	1 1/2	1 1/2	53	67	65
	100	100	304809	2	2	61	76	71

Notes: If you wish to order a fitting in stainless steel, please change the first two digit from **30....** to **31....** .
Articles available on request only.

FEMALE STUD BRANCH TEE ADAPTER

Thread NPT

Type: **3049..**

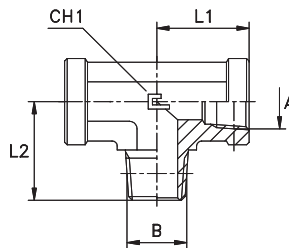

Series BS	30.... [bar]	31.... [bar]	Ordering Complete	A	B	L1	L2	CH1
UNIVERSAL	350	350	304901	1/8	1/8	17	20	14
			304902	1/4	1/4	22,5	28	19
	250	250	304903	3/8	3/8	26	31	22
	225	225	304904	1/2	1/2	31	37,5	27
	200	200	304905	3/4	3/4	34,5	40	33
	160	160	304906	1	1	41	50	41
			304907	1 1/4	1 1/4	43	60	48
			304908	1 1/2	1 1/2	53	67	65
	100	100	304909	2	2	61	76	71

Notes: If you wish to order a fitting in stainless steel, please change the first two digit from **30....** to **31....** .
Articles available on request only.

FEMALE EQUAL TEE ADAPTER

Thread BSP Parallel

Type: **3050..**

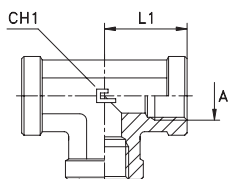

FEMALE EQUAL TEE ADAPTER

Thread NPT

Type: **3051..**

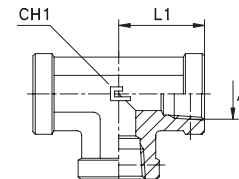

Series BS	30.... [bar]	31.... [bar]	Ordering Complete	A	L1	CH1
UNIVERSAL	350	350	305001	1/8	17	14
			305002	1/4	22,5	19
	250	250	305003	3/8	26	22
			305004	1/2	31	27
	200	200	305005	3/4	34,5	33
			305006	1	41	41
	160	160	305007	1 1/4	43	48
			305008	1 1/2	53	65
	100	100	305009	2	61	71

Notes: If you wish to order a fitting in stainless steel, please change the first two digit from **30....** to **31....** .

Series BS	30.... [bar]	31.... [bar]	Ordering Complete	A	L1	CH1
UNIVERSAL	350	350	305101	1/8	17	14
			305102	1/4	22,5	19
	250	250	305103	3/8	26	22
			305104	1/2	31	27
	200	200	305105	3/4	34,5	33
			305106	1	41	41
	160	160	305107	1 1/4	43	48
			305108	1 1/2	53	65
	100	100	305109	2	61	71

Notes: If you wish to order a fitting in stainless steel, please change the first two digit from **30....** to **31....** .
Articles available on scheduled orders only.

FEMALE EQUAL CROSS ADAPTER

Thread BSP Parallel

Type: **3052..**

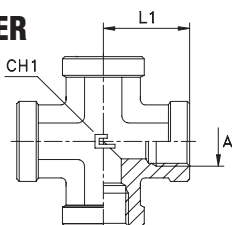

FEMALE EQUAL CROSS ADAPTER

Thread NPT

Type: **3053..**

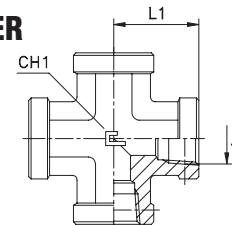

Serie BS	30.... [bar]	31.... [bar]	Ordering Complete	A	L1	CH1
UNIVERSAL	350	350	305201	1/8	17	14
			305202	1/4	22,5	19
	250	250	305203	3/8	26	22
			305204	1/2	31	27
	200	200	305205	3/4	34,5	33
			305206	1	41	41
	160	160	305207	1 1/4	43	48
			305208	1 1/2	53	65
	100	100	305209	2	61	71

Notes: If you wish to order a fitting in stainless steel, please change the first two digit from **30....** to **31....** .
Articles available on scheduled orders only.

Serie BS	30.... [bar]	31.... [bar]	Ordering Complete	A	L1	CH1
UNIVERSAL	350	350	305301	1/8	17	14
			305302	1/4	22,5	19
	250	250	305303	3/8	26	22
			305304	1/2	31	27
	200	200	305305	3/4	34,5	33
			305306	1	41	41
	160	160	305307	1 1/4	43	48
			305308	1 1/2	53	65
	100	100	305309	2	61	71

Notes: If you wish to order a fitting in stainless steel, please change the first two digit from **30....** to **31....** .
Articles available on scheduled orders only.

90° ADJUSTABLE ADAPTER WITH O-RING AND WASHER

Thread BSP Parallel

Type: 3054..

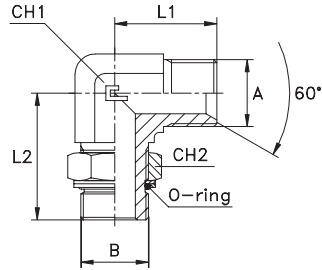

Series BS	30.... [bar]	31.... [bar]	Ordering Complete	A	B	L1	L2	CH1	CH2
UNIVERSAL	350	350	305401	1/8	1/8	21	26	11	14
			305402	1/4	1/8	26	30	14	14
	315	315	305403	1/4	1/4	26	32	14	19
			305404	3/8	1/4	29	37	19	19
	250	250	305405	3/8	3/8	29	37	19	22
			305406	1/2	3/8	34	39	22	22
			305407	1/2	1/2	34	43	22	30
			305408	3/4	1/2	41	47	27	30
			305409	3/4	3/4	41	49	27	36
			305410	1	3/4	45	50	33	36
	200	200	305411	1	1	45	52	33	41
			305412	1 1/4	1	52	58	41	41
	160	160	305413	1 1/4	1 1/4	52	58	41	50
			305414	1 1/2	1 1/4	59	59	48	50
	125	125	305415	1 1/2	1 1/2	59	60	48	55
			305416	2	1 1/2	78	74	65	55
				305417	2	2	78	74	65

Notes: If you wish to order a fitting in stainless steel, please change the first two digit from 30.... to 31.... .

90° ADJUSTABLE ADAPTER WITH O-RING AND WASHER

Thread Metric Parallel

Type: 3055..

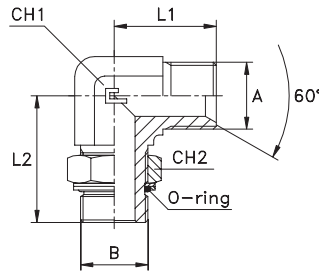

Series BS	30.... [bar]	31.... [bar]	Ordering Complete	A	B	L1	L2	CH1	CH2
UNIVERSAL	350	350	305501	12x1,5	10x1	21	27	11	14
			305502	12x1,5	12x1,5	24	31	14	17
	315	315	305503	14x1,5	12x1,5	26	31	14	17
			305504	14x1,5	14x1,5	26	33	14	19
			305505	16x1,5	14x1,5	29	36	19	19
			305506	16x1,5	16x1,5	29	38	19	22
			305507	18x1,5	16x1,5	29	38	19	22
			305508	18x1,5	18x1,5	29	38	19	24
			305509	22x1,5	18x1,5	34	40	22	24
	250	250	305510	22x1,5	22x1,5	34	42	22	27
			305511	26x1,5	22x1,5	41	46	27	27
			305512	26x1,5	27x2	41	50,5	27	32
	200	200	305513	30x1,5	27x2	45	52,5	33	32
			305514	30x1,5	33x2	45	52,5	33	41

Notes: If you wish to order a fitting in stainless steel, please change the first two digit from 30.... to 31.... .
Articles available on scheduled orders only.

45° ADJUSTABLE ADAPTER WITH O-RING AND WASHER

Thread BSP Parallel

Type: **3056..**

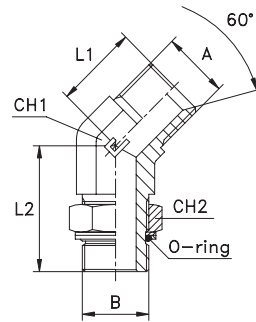

Series BS	30.... [bar]	31.... [bar]	Ordering Complete	A	B	L1	L2	CH1	CH2
UNIVERSAL	350	350	305601	1/8	1/8	20,5	26	11	14
			305602	1/4	1/8	21	27	14	14
	315	315	305603	1/4	1/4	21	29	14	19
			305604	3/8	1/4	23,5	32,5	19	19
	250	250	305605	3/8	3/8	23,5	33	19	22
			305606	1/2	3/8	26	35	22	22
			305607	1/2	1/2	26	38,5	22	30
			305608	3/4	1/2	32	38,5	27	30
			305609	3/4	3/4	32	44	27	36
			305610	1	3/4	37	44	33	36
	200	200	305611	1	1	37	47	33	41
			305612	1 1/4	1	39	45	41	41
			305613	1 1/4	1 1/4	39	48	41	50
	160	160	305614	1 1/2	1 1/4	46	48	48	50
			305615	1 1/2	1 1/2	46	48	48	55
	125	125	305616	2	1 1/2	57	57	65	55
			305617	2	2	57	57	65	70

Notes: If you wish to order a fitting in stainless steel, please change the first two digit from **30....** to **31....** .
Articles available on scheduled orders only.

45° ADJUSTABLE ADAPTER WITH O-RING AND WASHER

Thread Metric Parallel

Type: **3057..**

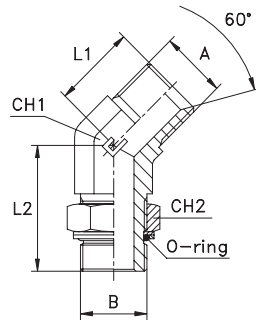

Series BS	30.... [bar]	31.... [bar]	Ordering Complete	A	B	L1	L2	CH1	CH2
UNIVERSAL	350	350	305701	12x1,5	10x1	20,5	27	11	14
			305702	12x1,5	12x1,5	21	27	14	17
	315	315	305703	14x1,5	12x1,5	21	27	14	17
			305704	14x1,5	14x1,5	21	33	14	19
			305705	16x1,5	14x1,5	23,5	30	19	19
			305706	16x1,5	16x1,5	23,5	33	19	22
			305707	18x1,5	16x1,5	23,5	33	19	22
			305708	18x1,5	18x1,5	23,5	33	19	24
			305709	22x1,5	18x1,5	26	36	22	24
	250	250	305710	22x1,5	22x1,5	26	38	22	27
			305711	26x1,5	22x1,5	32	37,5	27	27
			305712	26x1,5	27x2	32	46	27	32
	200	200	305713	30x1,5	27x2	37	46	33	32
			305714	30x1,5	33x2	37	46	33	41

Notes: If you wish to order a fitting in stainless steel, please change the first two digit from **30....** to **31....** .
Articles available on scheduled orders only.

ADJUSTABLE MALE STUD BARREL TEE WITH O-RING AND WASHER

Thread BSP Parallel

Type: **3058..**

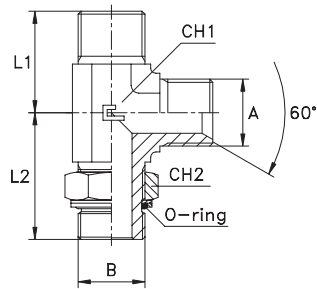

Series BS	30.... [bar]	31.... [bar]	Ordering Complete	A	B	L1	L2	CH1	CH2
UNIVERSAL	350	350	305801	1/8	1/8	21	26	11	14
			305802	1/4	1/8	26	30	14	14
	315	315	305803	1/4	1/4	26	32	14	19
			305804	3/8	1/4	29	37	19	19
	250	250	305805	3/8	3/8	29	37	19	22
			305806	1/2	3/8	34	39	22	22
			305807	1/2	1/2	34	43	22	30
			305808	3/4	1/2	41	47	27	30
			305809	3/4	3/4	41	49	27	36
	200	200	305810	1	3/4	45	50	33	36
			305811	1	1	45	52	33	41
			305812	1 1/4	1	52	58	41	41
	160	160	305813	1 1/4	1 1/4	52	58	41	50
			305814	1 1/2	1 1/4	59	59	48	50
	125	125	305815	1 1/2	1 1/2	59	60	48	55
			305816	2	1 1/2	78	74	65	55
			305817	2	2	78	74	65	70

Notes: If you wish to order a fitting in stainless steel, please change the first two digit from **30....** to **31....** .

ADJUSTABLE MALE STUD BARREL TEE WITH O-RING AND WASHER

Thread Metric Parallel

Type: **3059..**

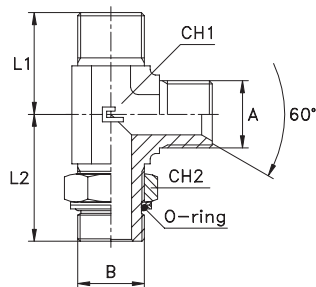

Series BS	30.... [bar]	31.... [bar]	Ordering Complete	A	B	L1	L2	CH1	CH2
UNIVERSAL	350	350	305901	12x1,5	10x1	21	27	11	14
			305902	12x1,5	12x1,5	24	31	14	17
	315	315	305903	14x1,5	12x1,5	26	31	14	17
			305904	14x1,5	14x1,5	26	33	14	19
			305905	16x1,5	14x1,5	29	36	19	19
			305906	16x1,5	16x1,5	29	38	19	22
			305907	18x1,5	16x1,5	29	38	19	22
			305908	18x1,5	18x1,5	29	38	19	24
			305909	22x1,5	18x1,5	34	40	22	24
	250	250	305910	22x1,5	22x1,5	34	42	22	27
			305911	26x1,5	22x1,5	41	46	27	27
			305912	26x1,5	27x2	41	50,5	27	32
	200	200	305913	30x1,5	27x2	45	52,5	33	32
			305914	30x1,5	33x2	45	52,5	33	41

Notes: If you wish to order a fitting in stainless steel, please change the first two digit from **30....** to **31....** .
Articles available on scheduled orders only.

ADJUSTABLE MALE STUD BRANCH TEE WITH O-RING AND WASHER

Thread BSP Parallel

Type: 3060..

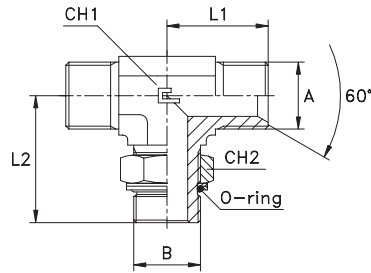

Series BS	30.... [bar]	31.... [bar]	Ordering Complete	A	B	L1	L2	CH1	CH2
UNIVERSAL	350	350	306001	1/8	1/8	21	26	11	14
			306002	1/4	1/8	26	30	14	14
	315	315	306003	1/4	1/4	26	32	14	19
			306004	3/8	1/4	29	37	19	19
	250	250	306005	3/8	3/8	29	37	19	22
			306006	1/2	3/8	34	39	22	22
			306007	1/2	1/2	34	43	22	30
			306008	3/4	1/2	41	47	27	30
			306009	3/4	3/4	41	49	27	36
			306010	1	3/4	45	50	33	36
	200	200	306011	1	1	45	52	33	41
			306012	1 1/4	1	52	58	41	41
			306013	1 1/4	1 1/4	52	58	41	50
	160	160	306014	1 1/2	1 1/4	59	59	48	50
			306015	1 1/2	1 1/2	59	60	48	55
	125	125	306016	2	1 1/2	78	74	65	55
			306017	2	2	78	74	65	70

Notes: If you wish to order a fitting in stainless steel, please change the first two digit from 30.... to 31.... .

ADJUSTABLE MALE STUD BRANCH TEE WITH O-RING AND WASHER

Thread Metric Parallel

Type: 3061..

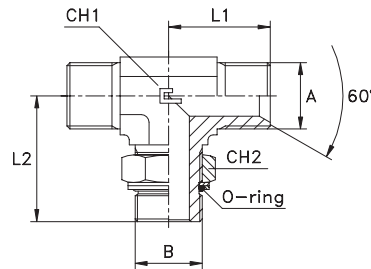

Series BS	30.... [bar]	31.... [bar]	Ordering Complete	A	B	L1	L2	CH1	CH2
UNIVERSAL	350	350	306101	12x1,5	10x1	21	27	11	14
			306102	12x1,5	12x1,5	24	31	14	17
	315	315	306103	14x1,5	12x1,5	26	31	14	17
			306104	14x1,5	14x1,5	26	33	14	19
			306105	16x1,5	14x1,5	29	34	19	19
			306106	16x1,5	16x1,5	29	38	19	22
			306107	18x1,5	16x1,5	29	38	19	22
			306108	18x1,5	18x1,5	29	38	19	24
			306109	22x1,5	18x1,5	34	40	22	24
	250	250	306110	22x1,5	22x1,5	34	42	22	27
			306111	26x1,5	22x1,5	41	44	27	27
			306112	26x1,5	27x2	41	50,5	27	32
	200	200	306113	30x1,5	27x2	45	50,5	33	32
			306114	30x1,5	33x2	45	52,5	33	41

Notes: If you wish to order a fitting in stainless steel, please change the first two digit from 30.... to 31.... .
Articles available on scheduled orders only.

90° ADAPTER WITH SWIVEL NUT

Thread BSP Parallel/BSP Taper

Type: **3062..**

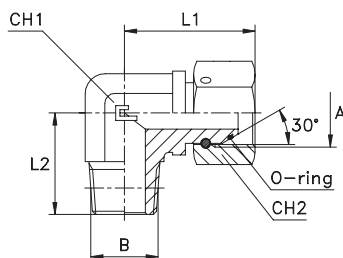

Series BS	30.... [bar]	31.... [bar]	Ordering Complete	A	B	L1	L2	CH1	CH2
UNIVERSAL	350	350	306201	1/8	1/8	25	20	11	14
			306202	1/4	1/4	33	28	14	19
	250	250	306203	3/8	3/8	37	31	19	22
	225	225	306204	1/2	1/2	43	37,5	22	27
	200	200	306205	5/8	1/2	49	37,5	27	30
			306206	3/4	3/4	53,5	40	27	32
	160	160	306207	1	1	60,5	50	33	41
			306208	1 1/4	1 1/4	64	60	41	50
			306209	1 1/2	1 1/2	72,5	67	48	55
	100	100	306210	2	2	91	76	65	70

Notes: If you wish to order a fitting in stainless steel, please change the first two digit from **30....** to **31....** .

90° ADAPTER WITH SWIVEL NUT

Thread BSP Parallel/NPT

Type: **3063..**

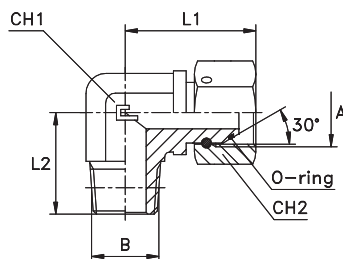

Series BS	30.... [bar]	31.... [bar]	Ordering Complete	A	B	L1	L2	CH1	CH2
UNIVERSAL	350	350	306301	1/8	1/8	25	20	11	14
			306302	1/4	1/4	33	28	14	19
	250	250	306303	3/8	3/8	37	31	19	22
	225	225	306304	1/2	1/2	43	37,5	22	27
	200	200	306305	5/8	1/2	49	37,5	27	30
			306306	3/4	3/4	53,5	40	27	32
	160	160	306307	1	1	60,5	50	33	41
			306308	1 1/4	1 1/4	64	60	41	50
			306309	1 1/2	1 1/2	72,5	67	48	55
	100	100	306310	2	2	91	76	65	70

Notes: If you wish to order a fitting in stainless steel, please change the first two digit from **30....** to **31....** .
Articles available on request only.

90° ADAPTER WITH SWIVEL NUT

Thread BSP Parallel

Type: **3064..**

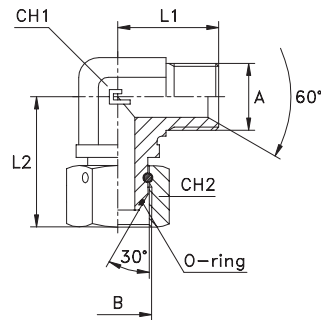

Series BS	30.... [bar]	31.... [bar]	Ordering Complete	A	B	L1	L2	CH1	CH2
UNIVERSAL	400	400	306401	1/8	1/8	21	25	11	14
			306402	1/4	1/4	26	33	14	19
			306403	3/8	3/8	29	37	19	22
	350	350	306404	1/2	1/2	34	43	22	27
			306405	5/8	5/8	38	49	27	30
	315	315	306406	3/4	3/4	41	53,5	27	32
	250	250	306407	1	1	45	60,5	33	41
	200	200	306408	1 1/4	1 1/4	57	64	41	50
	160	160	306409	1 1/2	1 1/2	59	75,5	48	55
	125	125	306410	2	2	78	91	65	70

Notes: If you wish to order a fitting in stainless steel, please change the first two digit from **30....** to **31....** .

90° ADAPTER WITH SWIVEL NUT THREAD

Thread Metric Parallel

Type: **3065..**

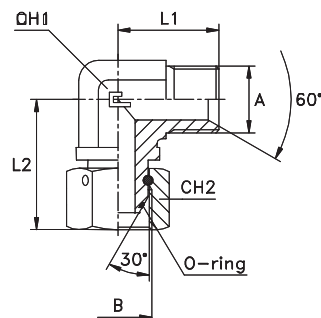

Series BS	30.... [bar]	31.... [bar]	Ordering Complete	A	B	L1	L2	CH1	CH2
UNIVERSAL	400	400	306501	12x1,5	12x1,5	21	26	11	14
			306502	14x1,5	14x1,5	26	33	14	19
			306503	16x1,5	16x1,5	29	37	19	22
			306504	18x1,5	18x1,5	29	38	19	24
	350	350	306505	20x1,5	20x1,5	34	44	22	27
			306506	22x1,5	22x1,5	34	44	22	27
	315	315	306507	26x1,5	26x1,5	41	53	27	32
	250	250	306508	30x1,5	30x1,5	45	58	33	36

Notes: If you wish to order a fitting in stainless steel, please change the first two digit from **30....** to **31....** .
Articles available on request only.

BARREL TEE ADAPTER WITH SWIVEL NUT

Thread BSP Parallel

Type: **3066..**

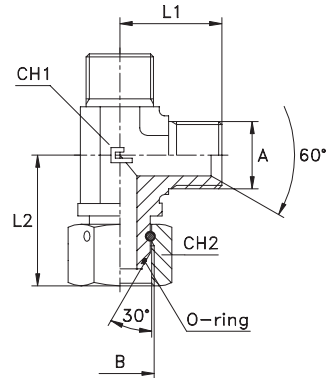

Series BS	30.... [bar]	31.... [bar]	Ordering Complete	A	B	L1	L2	CH1	CH2
UNIVERSAL	400	400	306601	1/8	1/8	21	25	11	14
			306602	1/4	1/4	26	33	14	19
			306603	3/8	3/8	29	37	19	22
	350	350	306604	1/2	1/2	34	43	22	27
			306605	5/8	5/8	38	49	27	30
	315	315	306606	3/4	3/4	41	53,5	27	32
	250	250	306607	1	1	45	60,5	33	41
	200	200	306608	1 1/4	1 1/4	57	64	41	50
	160	160	306609	1 1/2	1 1/2	59	72,5	48	55
	125	125	306610	2	2	78	91	65	70

Notes: If you wish to order a fitting in stainless steel, please change the first two digit from **30....** to **31....** .

BARREL TEE ADAPTER WITH SWIVEL NUT

Thread Metric Parallel

Type: **3067..**

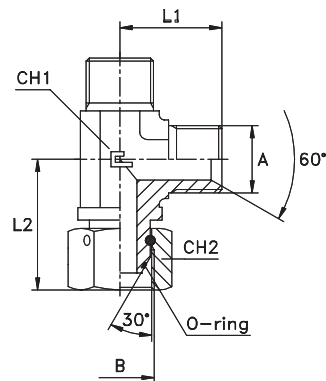

Series BS	30.... [bar]	31.... [bar]	Ordering Complete	A	B	L1	L2	CH1	CH2
UNIVERSAL	400	400	306701	12x1,5	12x1,5	21	26	11	14
			306702	14x1,5	14x1,5	26	33	14	19
			306703	16x1,5	16x1,5	29	37	19	22
			306704	18x1,5	18x1,5	29	38	19	24
	350	350	306705	20x1,5	20x1,5	34	44	22	27
			306706	22x1,5	22x1,5	34	44	22	27
	315	315	306707	26x1,5	26x1,5	41	53	27	32
	250	250	306708	30x1,5	30x1,5	45	58	33	36

Notes: If you wish to order a fitting in stainless steel, please change the first two digit from **30....** to **31....** .
Articles available on request only.

BRANCH TEE ADAPTER WITH SWIVEL NUT

Thread BSP Parallel

Type: **3068..**

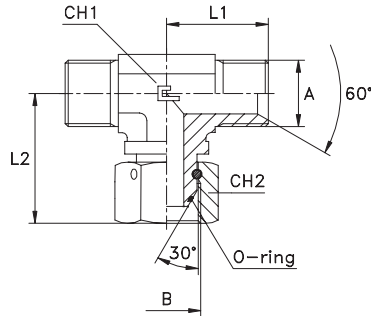

Series BS	30.... [bar]	31.... [bar]	Ordering Complete	A	B	L1	L2	CH1	CH2
UNIVERSAL	400	400	306801	1/8	1/8	21	25	11	14
			306802	1/4	1/4	26	33	14	19
			306803	3/8	3/8	29	37	19	22
	350	350	306804	1/2	1/2	34	43	22	27
			306805	5/8	5/8	38	49	27	30
	315	315	306806	3/4	3/4	41	53,5	27	32
	250	250	306807	1	1	45	60,5	33	41
	200	200	306808	1 1/4	1 1/4	57	64	41	50
	160	160	306809	1 1/2	1 1/2	59	72,5	48	55
	125	125	306810	2	2	78	91	65	70

Notes: If you wish to order a fitting in stainless steel, please change the first two digit from **30....** to **31....** .

BRANCH TEE ADAPTER WITH SWIVEL NUT

Thread Metric Parallel

Type: **3069..**

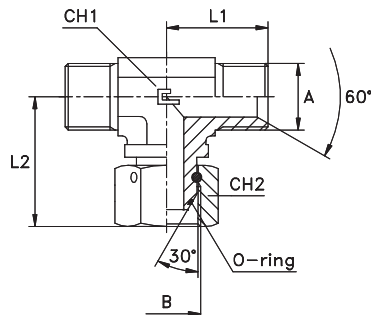

Series BS	30.... [bar]	31.... [bar]	Ordering Complete	A	B	L1	L2	CH1	CH2
UNIVERSAL	400	400	306901	12x1,5	12x1,5	21	26	11	14
			306902	14x1,5	14x1,5	26	33	14	19
			306903	16x1,5	16x1,5	29	37	19	22
			306904	18x1,5	18x1,5	29	38	19	24
	350	350	306905	20x1,5	20x1,5	34	44	22	27
			306906	22x1,5	22x1,5	34	44	22	27
	315	315	306907	26x1,5	26x1,5	41	53	27	32
	250	250	306908	30x1,5	30x1,5	45	58	33	36

Notes: If you wish to order a fitting in stainless steel, please change the first two digit from **30....** to **31....** .
Articles available on request only.

EQUAL TEE ADAPTER WITH SWIVEL NUT

Thread BSP Parallel

Type: **3070..**

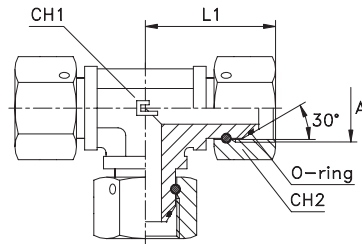

Series BS	30.... [bar]	31.... [bar]	Ordering Complete	A	L1	CH1	CH2
UNIVERSAL	400	400	307001	1/8	25	11	14
			307002	1/4	33	14	19
			307003	3/8	37	19	22
	350	350	307004	1/2	43	22	27
			307005	5/8	49	27	30
	315	315	307006	3/4	53,5	27	32
	250	250	307007	1	60,5	33	41
	200	200	307008	1 1/4	64	41	50
	160	160	307009	1 1/2	75,5	48	55
	125	125	307010	2	91	65	70

Notes: If you wish to order a fitting in stainless steel, please change the first two digit from **30....** to **31....** .

EQUAL TEE ADAPTER WITH SWIVEL NUT

Thread Metric Parallel

Type: **3071..**

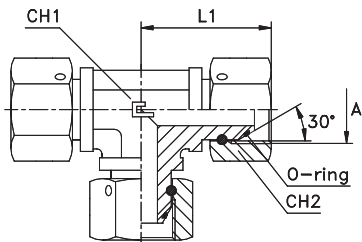

Series BS	30.... [bar]	31.... [bar]	Ordering Complete	A	L1	CH1	CH2
UNIVERSAL	400	400	307101	12x1,5	26	11	14
			307102	14x1,5	33	14	19
			307103	16x1,5	37	19	22
			307104	18x1,5	38	19	24
	350	350	307105	20x1,5	44	22	27
			307106	22x1,5	44	22	27
	315	315	307107	26x1,5	53	27	32
	250	250	307108	30x1,5	58	33	36

Notes: If you wish to order a fitting in stainless steel, please change the first two digit from **30....** to **31....** .
Articles available on request only.

MALE STUD ADAPTER WITH ELASTOMER SEAL

Thread BSP Parallel

Type: **3072..**

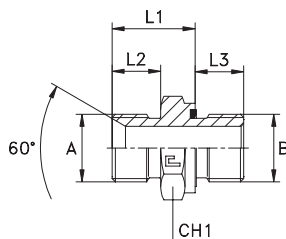

Series BS	30.... [bar]	31.... [bar]	Ordering Complete	A	B	L1	L2	L3	CH1
UNIVERSAL	350	350	307201	1/8	1/8	14,5	8	8	14
			307202	1/4	1/4	19	11	12	19
	250	250	307203	3/8	3/8	20,5	12	12	22
			307204	1/2	1/2	24	14	14	27
	200	200	307205	5/8	1/2	26	16	14	27
			307206	3/4	3/4	28	16	16	32
	160	160	307207	1	1	32	19	18	41
			307208	1 1/4	1 1/4	37	20	20	50
			307209	1 1/2	1 1/2	40	23	22	55
	100	100	307210	2	2	45,5	25	24	70

Notes: If you wish to order a fitting in stainless steel, please change the first two digit from **30....** to **31....** .
Articles available on request only.

MALE STUD ADAPTER WITH SWIVEL NUT AND ELASTOMER SEAL

Thread BSP Parallel

Type: **3073..**

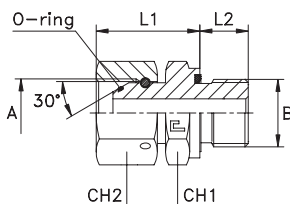

Series BS	30.... [bar]	31.... [bar]	Ordering Complete	A	B	L1	L2	CH1	CH2
UNIVERSAL	350	350	307301	1/8	1/8	20	8	14	14
			307302	1/4	1/4	25	12	19	19
	250	250	307303	3/8	3/8	27	12	22	22
			307304	1/2	1/2	31	14	27	27
	200	200	307305	5/8	1/2	35	14	27	30
			307306	3/4	3/4	37	16	32	32
	160	160	307307	1	1	44,5	18	41	41
			307308	1 1/4	1 1/4	47	20	50	50
			307309	1 1/2	1 1/2	54,5	22	55	55
	100	100	307310	2	2	62	24	70	70

Notes: If you wish to order a fitting in stainless steel, please change the first two digit from **30....** to **31....** .
Articles available on request only.

MALE STUD ADAPTER WITH O-RING AND WASHER

Thread BSP Parallel

Type: 3074..

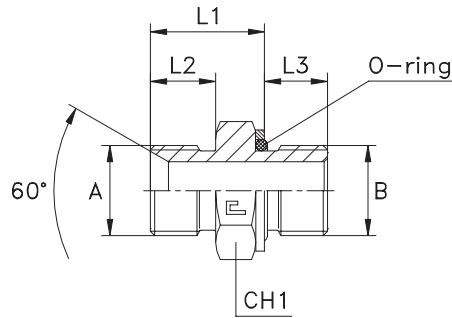

Series BS	30.... [bar]	31.... [bar]	Ordering Complete	A	B	L1	L2	L3	CH1
UNIVERSAL	350	350	307401	1/8	1/8	14,3	8	6,7	14
			307402	1/4	1/4	19,3	11	10,2	19
	250	250	307403	3/8	3/8	20,3	12	10,2	22
			307404	1/2	1/2	24,3	14	12,2	27
	200	200	307405	5/8	1/2	26,3	16	12,2	27
			307406	3/4	3/4	27,8	16	12,7	36
	160	160	307407	1	1	32,1	19	15,4	41
			307408	1 1/4	1 1/4	37	20	16	50
			307409	1 1/2	1 1/2	40	23	16	55
	100	100	307410	2	2	44,6	25	21,4	70

Notes: If you wish to order a fitting in stainless steel, please change the first two digit from 30.... to 31.... .
Articles available on request only.

MALE STUD ADAPTER WITH O-RING AND WASHER

Thread Metric Parallel

Type: 3075..

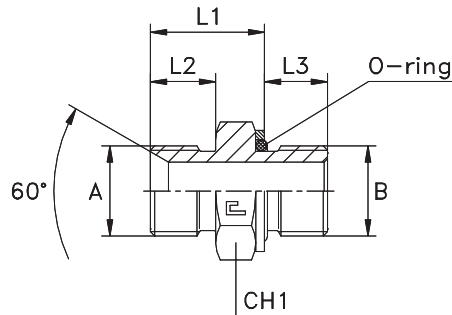

Series BS	30.... [bar]	31.... [bar]	Ordering Complete	A	B	L1	L2	L3	CH1
UNIVERSAL	350	350	307501	12x1,5	12x1,5	20,4	12	9,6	17
			307502	14x1,5	14x1,5	20,4	12	9,6	19
	250	250	307503	16x1,5	16x1,5	20,9	12	11,1	22
			307504	18x1,5	18x1,5	22,9	12	12,6	24
	225	225	307505	20x1,5	22x1,5	25,4	14	13,6	27
			307506	22x1,5	22x1,5	25,4	14	13,6	27
	200	200	307507	26x1,5	27x2	28,5	16	16,5	32
			307508	30x1,5	33x2	29,5	16	16,5	41

Notes: If you wish to order a fitting in stainless steel, please change the first two digit from 30.... to 31.... .
Articles available on request only.

MALE STUD ADAPTER WITH SWIVEL NUT O-RING AND WASHER

Thread BSP Parallel

Type: 3076..

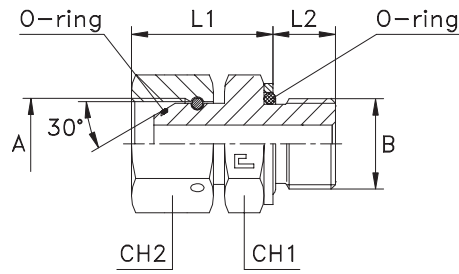

Series BS	30.... [bar]	31.... [bar]	Ordering Complete	A	B	L1	L2	CH1	CH2
UNIVERSAL	350	350	307601	1/8	1/8	19,8	6,7	14	14
			307602	1/4	1/4	25	10,2	19	19
	250	250	307603	3/8	3/8	26,3	10,2	22	22
			307604	1/2	1/2	30	12,2	27	27
	200	200	307605	5/8	1/2	33,8	12,2	27	27
			307606	3/4	3/4	35,8	12,7	36	32
	160	160	307607	1	1	44,1	15,4	41	41
			307608	1 1/4	1 1/4	46,6	16	50	50
			307609	1 1/2	1 1/2	54,1	16	55	55
	100	100	307610	2	2	61,1	21,4	70	70

Notes: If you wish to order a fitting in stainless steel, please change the first two digit from 30.... to 31.... .
Articles available on request only.

MALE STUD ADAPTER WITH SWIVEL NUT O-RING AND WASHER

Thread Metric Parallel

Type: 3077..

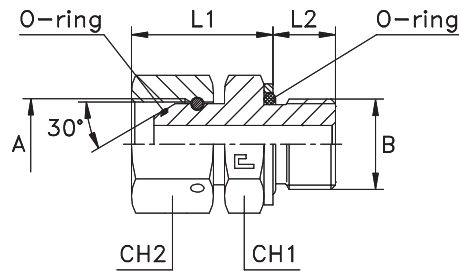

Series BS	30.... [bar]	31.... [bar]	Ordering Complete	A	B	L1	L2	CH1	CH2
UNIVERSAL	350	350	307701	12x1,5	12x1,5	23,4	9,6	17	17
	300	300	307702	14x1,5	14x1,5	25,6	9,6	19	19
	250	250	307703	16x1,5	16x1,5	26,9	11,1	22	22
			307704	18x1,5	18x1,5	29,9	12,6	24	24
	225	225	307705	20x1,5	22x1,5	33,4	13,6	27	27
			307706	22x1,5	22x1,5	34,4	13,6	27	27
	200	200	307707	26x1,5	27x2	37,7	16,5	32	32
			307708	30x1,5	33x2	40,6	16,5	36	36

Notes: If you wish to order a fitting in stainless steel, please change the first two digit from 30.... to 31.... .
Articles available on request only.

MALE PLUG

Thread BSP Parallel

Type: **3078..**

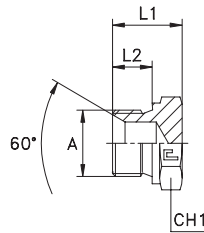

Series BS	30.... [bar]	31.... [bar]	Ordering Complete	A	L1	L2	CH1
UNIVERSAL	400	400	307801	1/8	14,5	8	14
			307802	1/4	19	11	19
			307803	3/8	20,5	12	22
	350	350	307804	1/2	24	14	27
			307805	5/8	26	16	30
	315	315	307806	3/4	28	16	32
	250	250	307807	1	32	19	41
	200	200	307808	1 1/4	35	20	50
	160	160	307809	1 1/2	40	23	55
	125	125	307810	2	45,5	25	70

Notes: If you wish to order a fitting in stainless steel, please change the first two digit from **30....** to **31....** .
Articles available on scheduled orders only.
For copper washer sealing systems refer to items **3001..** pressure rates.

FEMALE PLUG WITH SWIVEL NUT

Thread BSP Parallel

Type: **3079..**

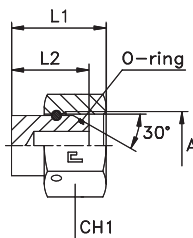

Series BS	30.... [bar]	31.... [bar]	Ordering Complete	A	L1	L2	CH1
UNIVERSAL	400	400	307901	1/8	15	12	14
			307902	1/4	19	15	19
			307903	3/8	20	15	22
	350	350	307904	1/2	24	19	27
			307905	5/8	26	19	30
	315	315	307906	3/4	30	21	32
	250	250	307907	1	35	24,5	41
	200	200	307908	1 1/4	36	27	50
	160	160	307909	1 1/2	42	29,5	55
	125	125	307910	2	45	30	70

Notes: If you wish to order a fitting in stainless steel, please change the first two digit from **30....** to **31....** .
Articles available on request only.

90° ELBOW ADAPTER WITH DOUBLE SWIVEL NUT

Thread BSP Parallel

Type: **3080..**

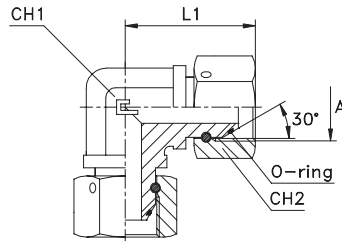

Series BS	30.... [bar]	31.... [bar]	Ordering Complete	A	L1	CH1	CH2
UNIVERSAL	400	400	308001	1/8	25	11	14
			308002	1/4	33	14	19
			308003	3/8	37	19	22
	350	350	308004	1/2	43	22	27
			308005	5/8	49	27	30
	315	315	308006	3/4	53,5	27	32
	250	250	308007	1	60,5	33	41
	200	200	308008	1 1/4	64	41	50
	160	160	308009	1 1/2	72,5	48	55
	125	125	308010	2	91	65	70

Notes: If you wish to order a fitting in stainless steel, please change the first two digit from **30....** to **31....** .
Articles available on request only.

90° ELBOW ADAPTER WITH DOUBLE SWIVEL NUT

Thread Metric Parallel

Type: **3081..**

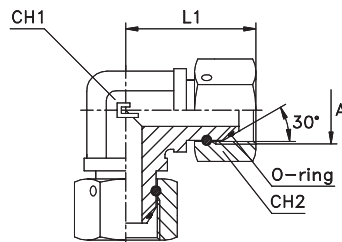

Series BS	30.... [bar]	31.... [bar]	Ordering Complete	A	L1	CH1	CH2
UNIVERSAL	400	400	308101	12x1,5	26	11	14
			308102	14x1,5	33	14	19
			308103	16x1,5	37	19	22
			308104	18x1,5	38	19	24
	350	350	308105	20x1,5	44	22	27
			308106	22x1,5	44	22	27
	315	315	308107	26x1,5	53	27	32
	250	250	308108	30x1,5	58	33	36

Notes: If you wish to order a fitting in stainless steel, please change the first two digit from **30....** to **31....** .
Articles available on request only.

45° ELBOW ADAPTER WITH SWIVEL NUT

Thread BSP Parallel

Type: **3082..**

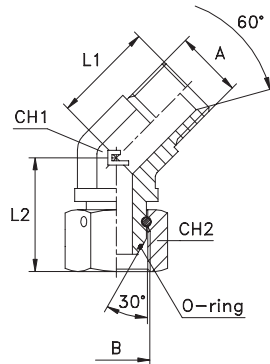

Series BS	30.... [bar]	31.... [bar]	Ordering Complete	A	B	L1	L2	CH1	CH2
UNIVERSAL	400	400	308201	1/8	1/8	20,5	23	11	14
			308202	1/4	1/4	21	25	14	19
			308203	3/8	3/8	23,5	29	19	22
	350	350	308204	1/2	1/2	26	32	22	27
			308205	5/8	5/8	29	39	27	30
	315	315	308206	3/4	3/4	32	41,5	27	32
	250	250	308207	1	1	37	45	33	41
	200	200	308208	1 1/4	1 1/4	39	47	41	50
	160	160	308209	1 1/2	1 1/2	46	58,5	48	55
	125	125	308210	2	2	56	72	65	70

Notes: If you wish to order a fitting in stainless steel, please change the first two digit from **30....** to **31....** .
Articles available on request only.

45° ELBOW ADAPTER WITH SWIVEL NUT

Thread Metric Parallel

Type: **3083..**

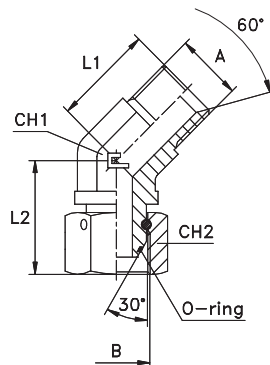

Series BS	30.... [bar]	31.... [bar]	Ordering Complete	A	B	L1	L2	CH1	CH2
UNIVERSAL	400	400	308301	12x1,5	12x1,5	18	24	11	14
			308302	14x1,5	14x1,5	21	25	14	19
			308303	16x1,5	16x1,5	25	29	19	22
			308304	18x1,5	18x1,5	28	30	19	24
	350	350	308305	20x1,5	20x1,5	30	33	22	27
			308306	22x1,5	22x1,5	30	33	22	27
	315	315	308307	26x1,5	26x1,5	33	41	27	32
	250	250	308308	30x1,5	30x1,5	37	42,5	33	36

Notes: If you wish to order a fitting in stainless steel, please change the first two digit from **30....** to **31....** .
Articles available on request only.

90° ADJUSTABLE ADAPTER WITH SWIVEL NUT O-RING AND WASHER

Thread BSP Parallel

Type: **3084..**

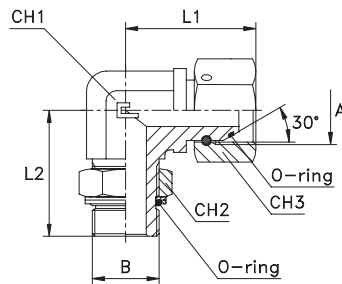

Series BS	30.... [bar]	31.... [bar]	Ordering Complete	A	B	L1	L2	CH1	CH2	CH3
UNIVERSAL	350	350	308401	1/8	1/8	25	26	11	14	14
			308402	1/4	1/8	33	30	14	14	19
	315	315	308403	1/4	1/4	33	32	14	19	19
			308404	3/8	1/4	37	37	19	19	22
	250	250	308405	3/8	3/8	37	37	19	22	22
			308406	1/2	3/8	43	39	22	22	27
			308407	1/2	1/2	43	43	22	30	27
			308408	3/4	1/2	53,5	47	27	30	32
			308409	3/4	3/4	53,5	49	27	36	32
			308410	1	3/4	60,5	50	33	36	41
	200	200	308411	1	1	60,5	52	33	41	41
			308412	1 1/4	1	64	58	41	41	50
			308413	1 1/4	1 1/4	64	58	41	50	50
	160	160	308414	1 1/2	1 1/4	72,5	59	48	50	55
			308415	1 1/2	1 1/2	72,5	60	48	55	55
	125	125	308416	2	1 1/2	91	74	65	55	70
			308417	2	2	91	74	65	70	70

Notes: If you wish to order a fitting in stainless steel, please change the first two digit from **30....** to **31....** .
Articles available on request only.

90° ADJUSTABLE ADAPTER WITH SWIVEL NUT O-RING AND WASHER

Thread Metric Parallel

Type: **3085..**

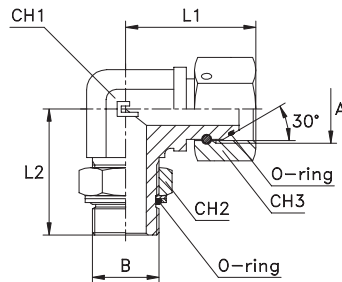

Series BS	30.... [bar]	31.... [bar]	Ordering Complete	A	B	L1	L2	CH1	CH2	CH3
UNIVERSAL	350	350	308501	12x1,5	10x1	26	27	11	14	14
			308502	12x1,5	12x1,5	26	31	14	17	14
	315	315	308503	14x1,5	12x1,5	33	31	14	17	19
			308504	14x1,5	14x1,5	33	33	14	19	19
			308505	16x1,5	14x1,5	37	36	19	19	22
			308506	16x1,5	16x1,5	37	38	19	22	22
			308507	18x1,5	16x1,5	38	38	19	22	24
			308508	18x1,5	18x1,5	38	38	19	24	24
			308509	22x1,5	18x1,5	44	40	22	24	27
	250	250	308510	22x1,5	22x1,5	44	42	22	27	27
			308511	26x1,5	22x1,5	53	46	27	27	32
			308512	26x1,5	27x2	53	50,5	27	32	32
			308513	30x1,5	27x2	58	52,5	33	32	36
	200	200	308514	30x1,5	33x2	58	52,5	33	41	36

Notes: If you wish to order a fitting in stainless steel, please change the first two digit from **30....** to **31....** .
Articles available on request only.

ADJUSTABLE ADAPTER WITH SWIVEL NUT O-RING AND WASHER

Thread BSP Parallel

Type: **3086..**

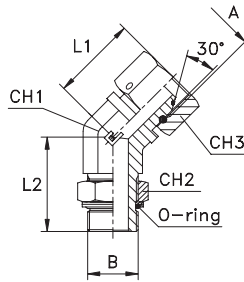

Series BS	30.... [bar]	31.... [bar]	Ordering Complete	A	B	L1	L2	CH1	CH2	CH3
UNIVERSAL	350	350	308601	1/8	1/8	23	26	11	14	14
			308602	1/4	1/8	25	27	14	14	19
	315	315	308603	1/4	1/4	25	29	14	19	19
			308604	3/8	1/4	29	30	19	19	22
	250	250	308605	3/8	3/8	29	33	19	22	22
			308606	1/2	3/8	32	35	22	22	27
			308607	1/2	1/2	32	38,5	22	30	27
			308608	3/4	1/2	41,5	38,5	27	30	32
			308609	3/4	3/4	41,5	44	27	36	32
			308610	1	3/4	45	44	33	36	41
	200	200	308611	1	1	45	47	33	41	41
			308612	1 1/4	1	47	45	41	41	50
			308613	1 1/4	1 1/4	47	48	41	50	50
	160	160	308614	1 1/2	1 1/4	58,5	48	48	50	55
			308615	1 1/2	1 1/2	58,5	48	48	55	55
	125	125	308616	2	1 1/2	72	57	65	55	70
			308617	2	2	72	57	65	70	70

Notes: If you wish to order a fitting in stainless steel, please change the first two digit from **30....** to **31....** .
Articles available on request only.

ADJUSTABLE ADAPTER WITH SWIVEL NUT O-RING AND WASHER

Thread Metric Parallel

Type: **3087..**

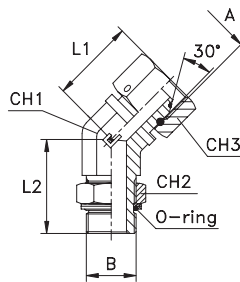

Series BS	30.... [bar]	31.... [bar]	Ordering Complete	A	B	L1	L2	CH1	CH2	CH3
UNIVERSAL	350	350	308701	12x1,5	10x1	24	27	11	14	14
			308702	12x1,5	12x1,5	24	27	14	17	14
	315	315	308703	14x1,5	12x1,5	25	27	14	17	19
			308704	14x1,5	14x1,5	25	33	14	19	19
			308705	16x1,5	14x1,5	29	30	19	19	22
			308706	16x1,5	16x1,5	29	33	19	22	22
			308707	18x1,5	16x1,5	30	33	19	22	24
			308708	18x1,5	18x1,5	30	33	19	24	24
			308709	22x1,5	18x1,5	33	36	22	24	27
	250	250	308710	22x1,5	22x1,5	33	38	22	27	27
			308711	26x1,5	22x1,5	41	37,5	27	27	32
			308712	26x1,5	27x2	41	46	27	32	32
	200	200	308713	30x1,5	27x2	42,5	46	33	32	36
			308714	30x1,5	33x2	42,5	46	33	41	36

Notes: If you wish to order a fitting in stainless steel, please change the first two digit from **30....** to **31....** .
Articles available on request only.

EXAGONAL NUT

Thread BSP Parallel

Type: **0023...**

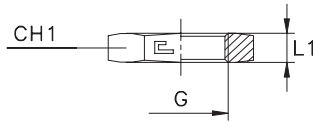

Serie BS	30... [bar]	31... [bar]	Ordering Complete	G	L1	CH1
UNIVERSAL	400	400	002301	1/8	5,5	14
			002302	1/4	6	19
			002303	3/8	7	22
	350	350	002304	1/2	8,5	27
	315	315	002305-CH32	3/4	9	32
	250	250	002306	1	10,4	41
	200	200	002307	1 1/4	11	50
	160	160	002308	1 1/2	12	55
	125	125	002309	2	12	70

Notes: If you wish to order a fitting in stainless steel, please change the first two digit from **00...** to **01....**

FEMALE NON RETURN VALVE THREAD BSP PARALLEL

Thread BSP Parallel - Thread Metric Parallel

Type: **5010..**
Type: **5011..**

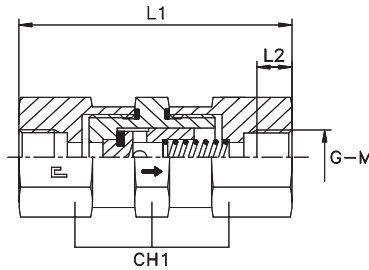

Serie BS	50... [bar]	51... [bar]	Ordering Complete	G	L1	L2	CH1	Ø pass.
S	400	400	501001	1/8	70	10	19	4
			501002	1/4	80	14	19	4
			501003	3/8	88	14	32	8
			501004	1/2	103	17	41	11
			501005	3/4	110	19	50	16
	250	250	501006	1	122	21,5	50	18
			501007	1 1/4	142	23,5	70	29
			501008	1 1/2	142	25,5	70	29

Notes: If you wish to order a fitting in stainless steel, please change the first two digit from **50...** to **51....**
Articles available on scheduled orders only.

Serie BS	50... [bar]	51... [bar]	Ordering Complete	M	L1	L2	CH1	Ø pass.
S	400	400	501101	10x1	70	10	19	4
			501102	14x1,5	80	14,5	19	4
			501103	16x1,5	88	14,5	32	8
			501104	22x1,5	103	16,5	41	11
			501105	27x2	110	19	50	16
	250	250	501106	33x2	122	21	50	18
			501107	42x2	142	23	70	29
			501108	48x2	142	25	70	29

Notes: If you wish to order a fitting in stainless steel, please change the first two digit from **50...** to **51....**
Articles available on scheduled orders only.

FEMALE NON RETURN VALVE THREAD BSP TAPER

Thread BSP Taper -Thread NPT

Type: **5012..**

Type: **5013..**

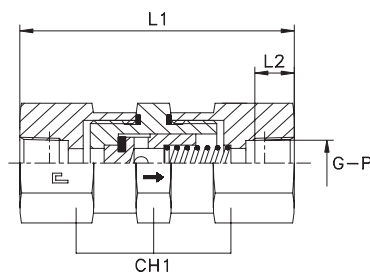

Serie BS	50.... [bar]	51.... [bar]	Ordering Complete	G	L1	L2	CH1	Ø pass.
UNIVERSAL	400	400	501201	1/8	70	9,5	19	4
			501202	1/4	80	14	19	4
			501203	3/8	88	14,5	32	8
			501204	1/2	103	19	41	11
			501205	3/4	110	19,5	50	16
	250	250	501206	1	122	23,5	50	18
			501207	1 1/4	142	24	70	29
			501208	1 1/2	142	24	70	29

Notes: If you wish to order a fitting in stainless steel, please change the first two digit from **50....** to **51....** .
Articles available on scheduled orders only.

Serie BS	50.... [bar]	51.... [bar]	Ordering Complete	P	L1	L2	CH1	Ø pass.
UNIVERSAL	400	400	501301	1/8	70	9,5	19	4
			501302	1/4	80	14	19	4
			501303	3/8	88	14,5	32	8
			501304	1/2	103	19	41	11
			501305	3/4	110	19,5	50	16
	250	250	501306	1	122	23,5	50	18
			501307	1 1/4	142	24	70	29
			501308	1 1/2	142	24	70	29

Notes: If you wish to order a fitting in stainless steel, please change the first two digit from **50....** to **51....** .
Articles available on scheduled orders only.

PRODUCTION PLANT no. 1-2 OF CASALGRASSO (CN)

Production plant of CAST S.p.A.





SAE-J1453



















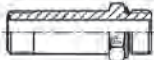





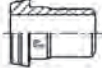

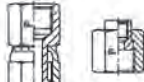















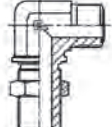
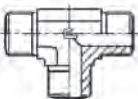
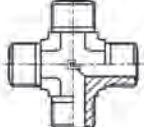
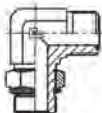
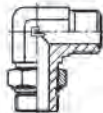

ORFS

AVAILABLE IN CARBON AND STAINLESS STEEL

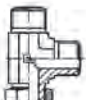
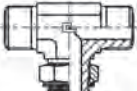
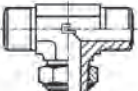
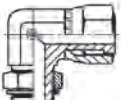
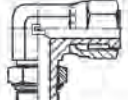
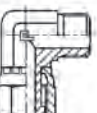
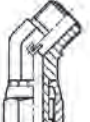
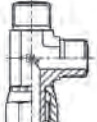
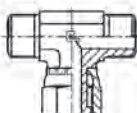
40

FIGURATIVE INDEX – FITTINGS SAE J1453 - ISO 8434-3

General instructions	Quality assurance	Allowed temperatures	Finish treatments	Tubes to be used	Threaded ends	Prescriptions to comply with
Utilisation standards	Safety factors	Seals on threads	End treatments	Tables follow up	Gas - Metric UNF - NPT	Assembly instructions
Page 215	Page 22	Page 23	Page 24	Page 25-26	Page 27-32	Page 33;39;216-219
Type: 4001.. 	Type: 4002.. 	Type: 4003.. 	Type: 4004.. BSPP Type: 4005.. Metric paral. 	Type: 4006.. UNF/UN-2A 	Type: 4007.. BSPP Type: 4008.. Metric paral. 	Type: 4009.. NPTF 
Page 220	Page 221	Page 222	Page 222-223	Page 224	Page 225-226	Page 226
Type: 4010.. BSPP 	Type: 4011.. NPTF 	Type: 4012.. BSPP 	Type: 4015.. BSPP 	Type: 4017.. 	Type: 4018.. 	Type: 4019.. 
Page 227	Page 227	Page 228	Page 228	Page 229	Page 229	Page 230
Type: 4020.. 	Type: 4021.. 	Type: 4022.. BSPP Type: 4023.. Metric paral. 	Type: 4024.. BSPP Type: 4025.. Metric paral. 	Type: 4026.. ORFS/DIN 	Type: 4027.. ORFS/DIN gir. 	Type: 4028.. 3 ORFS/JIC 
Page 231-232	Page 232	Page 233	Page 234	Page 235	Page 235	Page 236
Type: 4029.. ORFS/JIC gir. 	Type: 4030...3 ORFS gir. JIC 	Type: 4031.. ORFS/BSI 	Type: 4032.. ORFS gir. BSI 	Type: 4033.. BSPP Type: 4034.. Metric paral. 	Type: 4035.. ORFS/UN-2A 	Type: 4036.. BSPP Type: 4037.. Metric paral. 
Page 236	Page 237	Page 237	Page 238	Page 239	Page 240	Page 240-241
Type: 4038.. 	Type: 4039.. NPTF 	Type: 4040.. NPTF 	Type: 4041.. 	Type: 4042.. 	Type: 4043.. 	Type: 4044.. 
Page 241	Page 242	Page 242	Page 243	Page 243	Page 244	Page 244
Type: 4045.. 	Type: 4046.. 	Type: 4049.. 	Type: 4050.. 	Type: 4051.. BSPP Type: 4052.. Metric paral. 	Type: 4053.. UNF/UN-2A 	Type: 4054.. BSPP 
Page 245	Page 245	Page 246	Page 246	Page 247	Page 248	Page 249
Type: 4056.. UNF/UN-2A 	Type: 4057.. BSPP 	Type: 4059.. UNF/UN-2A 	Type: 4060.. BSPP 	Type: 4062.. UNF/UN-2A 	Type: 4069.. BSPP 	Type: 4071.. UNF/UN-2A 
Page 250	Page 251	Page 252	Page 253	Page 254	Page 255	Page 255
Type: 4072.. 	Type: 4073.. 	Type: 4074.. 	Type: 4075.. 	Type: 4076.. 	Type: 4077.. 	Type: 4078.. 
Page 256	Page 256	Page 257	Page 257	Page 258	Page 258	Page 258

ORDERING EXAMPLES (Carbon steel)

ORDERING EXAMPLES (Stainless steel)

ORFS

- If you require a male stud coupling for a \varnothing 20 mm tube with 3/4" BSP parallel thread made of carbon steel with elastomeric NBR seal on the threaded end, order: 400405

- If you require the VITON® seal, add "V" at the end.

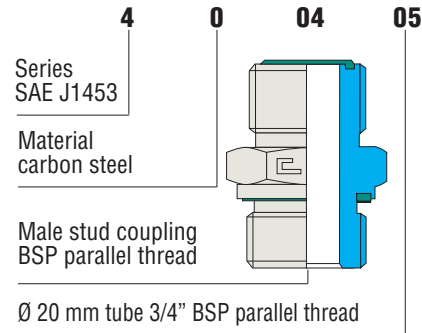

ORFS

- If you require a male stud coupling for a \varnothing 20 mm tube with 3/4" BSP parallel thread made of stainless steel with elastomeric VITON® seal on the threaded end, order: 410405

- If you require the NBR seal, add ".N" at the end.

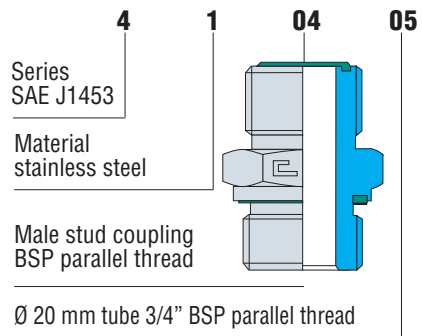

ORFS

- If you wish to use a steel tube with inch measurements, add the letter ".W" to the code of the pressure sleeve to order: 400105.W

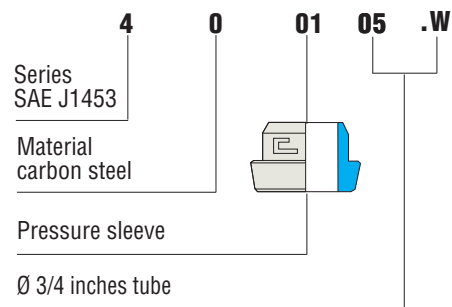

DELIVERIES

- Cast S.p.A. fittings are delivered in the configurations shown in the tables of this catalogue.
- Available on scheduled orders only: it means that the article is slow moving and will be delivered within 90 days.
- Available on request only: it means that the article is not commonly in stock; please contact our offices for further delivery details.

VITON® is a DuPont Dow Elastomers Trade Mark

THEORY OF OPERATION-FLARED TUBE

The CAST fitting, manufactured according to ISO 8434-3/SAE J1453, is a mechanical fitting traditionally used for high pressure fluid-dynamic systems. The sealing is made between two flat surfaces, metal to metal, with no deformation of the components, plus an elastomeric sealing (O-Ring) placed into a groove on the front surface of the fitting.

The coupling between the body of the fitting and the flared tube is guaranteed by the tightening nut and by the sleeve on the inside. It helps fast assembly of removable tubes, avoids welding and tapping, thus assuring maximum simplicity for complex oleo-dynamic systems. Repeated assemblies do not alter the performance of the coupling.

COUPLING SYSTEM SAE J1453

Reference prescriptions:

Traceability decoding:

CAST =
Logo of the Manufacturer

- T =
Production plant
- 3 =
Year of manufacture
- CE =
Made in EEC
- 50 =
Type of steel used
- 01 =
Heat number of the steel used

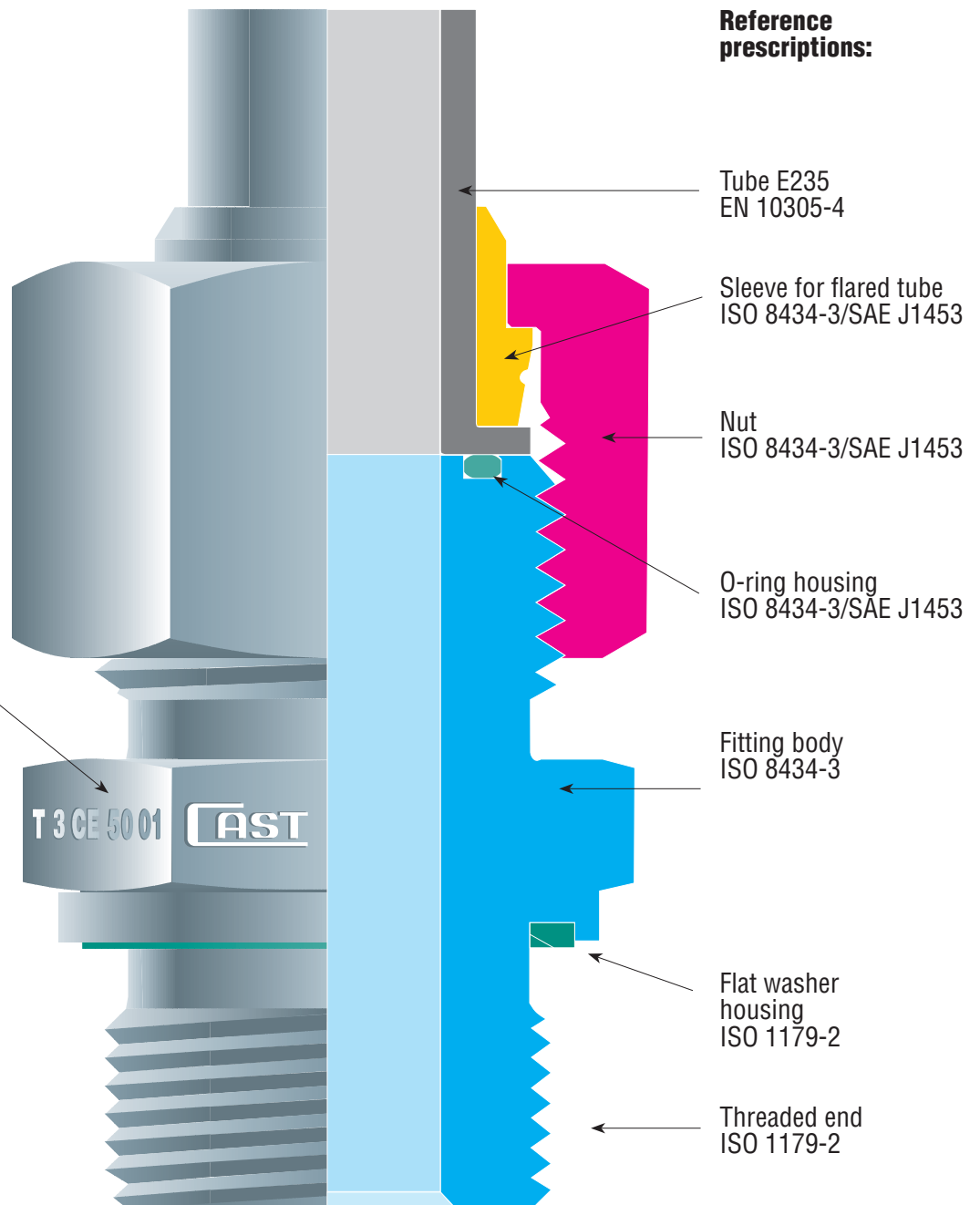

THEORY OF OPERATION - BRAZED TUBE

The CAST fitting, manufactured according to ISO 8434-3/SAE J1453, is a mechanical fitting traditionally used for high pressure fluid-dynamic systems. The sealing is made between two flat surfaces, metal to metal, with no deformation of the components, plus an elastomeric sealing (O-Ring) placed into a groove on the front surface of the fitting.

The coupling between the body of the fitting and the brazed tube is guaranteed by the tightening nut. It helps fast assembly of removable tubes, avoids flarings and tapping, thus assuring maximum simplicity for complex oleo-dynamic systems. Repeated assemblies do not alter the performance of the coupling.

COUPLING SYSTEM SAE J1453

Traceability decoding:

CAST =
Logo of the
Manufacturer

- T =
Production plant
- 3 =
Year of manufacture
- CE =
Made in EEC
- 50 =
Type of steel used
- 01 =
Heat number of the
steel used

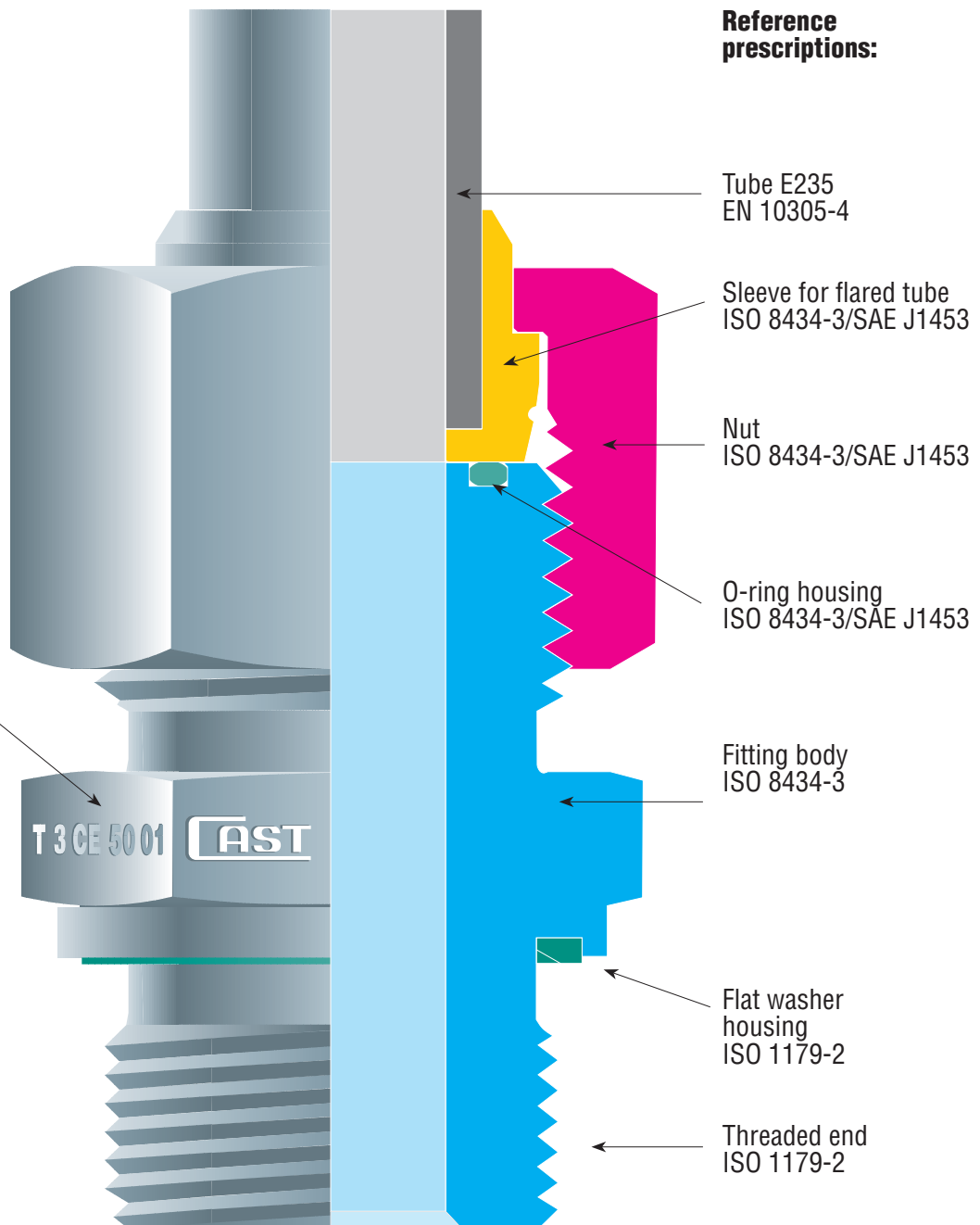

Reference prescriptions:

- Tube E235
EN 10305-4
- Sleeve for flared tube
ISO 8434-3/SAE J1453
- Nut
ISO 8434-3/SAE J1453
- O-ring housing
ISO 8434-3/SAE J1453
- Fitting body
ISO 8434-3
- Flat washer housing
ISO 1179-2
- Threaded end
ISO 1179-2

TECHNICAL CHARACTERISTICS - FLARED TUBE

The CAST ORFS fittings assure perfect seal regardless of the fluid used, provided that no corrosive fluids be employed, the nominal pressures of the fittings and the indicated temperatures be respected and the prescriptions of the manufacturer be followed scrupulously.

These fittings are manufactured in a single series defined "UNIVERSAL" since the fitting body and the tightening nut remain the same also when switching from a metric tube at an inches sized tube. There are no doubles of diameters with different working pressures.

Normal vibrations do not alter the functionality of this type of fitting, also at the top quoted values. Therefore the fitting maintains its best characteristics of absolute guarantee, safety and reliability. For these specific reasons this fitting may be used in hard working conditions.

Under the mechanical strength given by the tightening of the nut on the fitting body, the part of the flared tube and the part of the brazed tube united with the sleeve couple with the front surface of the fitting body to provide a very effective metal to metal seal supported by the elastomeric seal as well.

The flared sleeve housed inside the tightening nut ensures the self-alignment of the flared tube to the axis of the fitting body, supports the tube during operation, lowers the vibrations and avoids damage to the tube while tightening.

Before assembly on the metal tube



After assembly on the metal tube

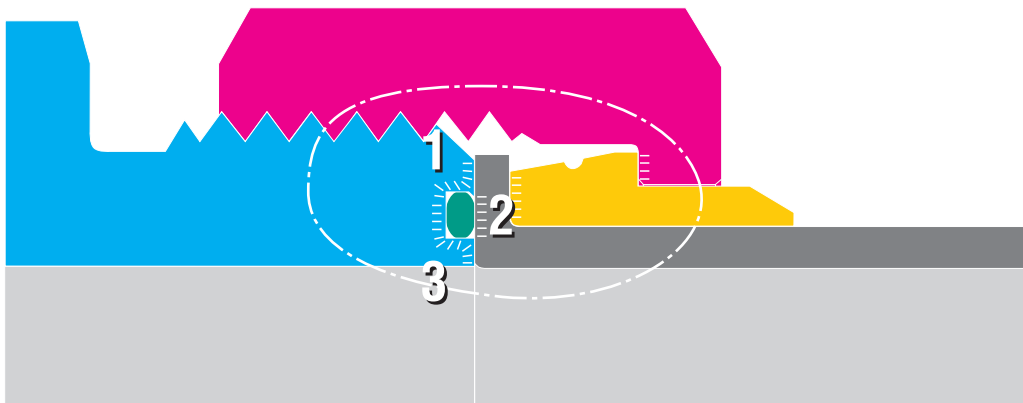

Field of force
- - - - -

Pressure surfaces
|||||

Sealing points
1-2-3

SEALING

The new ORFS fitting solves the total sealing problem in the following way:

- On the front side of the fitting a groove was created to insert an O-ring. This elastomeric seal guarantees a perfect seal at all times, as dry as dust.
- The particular shape of the groove, according to the new prescriptions of standards ISO 8434-3 and SAE J1453, guarantees the containment of the O-Ring inside its groove without the assistance of adhesives.
- The presence of the O-Ring groove improves the sealing metal to metal characteristics, since the groove divides the front seal surface of the fitting in two. The new ORFS fitting solves the problem of small leakages, leaks and sweating that are typical of a metal to metal sealing system on high pressure fittings.
- Strenuous tests carried out in our technical laboratory in Casalgrasso (CN) have clarified, beyond any doubt, the reliability of the sealing of this range of oleo-dynamic fittings.

GENERAL INSTRUCTIONS

- Before starting to flare the tubes, please check that all the tools to be used in the process conform to the standards. Carefully check the tools every 30-50 flarings.
- Before starting to braze the tubes, please check that all the tools to be used in the process conform to the standards. Always check the compliance of the brazing.
- Before assembling the preassembled tube to the equipment it is necessary to check that the tube and the fitting are aligned. Fittings should never be used to correct a wrong alignment or to be a support for the tube. Extremely long tubes or tubes undergoing high stress must be fixed by using some support to avoid excessive vibrations. A poor alignment could damage the operation of the system.
- The proper lubrication of the components involved in the tightening is essential for good system operation. We advise the use of mineral oils or torquen tension for carbon steel fittings, consisting of anti-seizing compound (Nickel based), Chesterton or similar, for stainless steel fittings.
- Indicated pressures are for steel tubes only.
- The fittings in this technical catalogue may be used for fluid-dynamic connections only.
- Mixing carbon and stainless steel components is not allowed.

UTILISATION STANDARDS

CARBON STEEL FITTINGS

- High quality tubes must be employed to assure correct use and related technical performance of the carbon steel fitting. The use of tubes without the aforementioned characteristics may seriously impair the efficiency of the fitting. We recommend using the following tubes only: calibrated and polished, cold drawn seamless tubes, normalised with inert gas, in E235 material according to EN 10305-4 (ST 37.4 according to DIN 1630 I DIN 2391). The maximum hardness allowed on the outside diameter of the tube is 75 HRB.
- The flaring of the tube must be carried out with extreme care and precision. It is important that the flaring is concentric and perpendicular compared to the tube and sleeve.
- Brazing the tube must be carried out with suitable materials. It is important that the brazing is carried out in a way to ensure the perfect perpendicularity of the sleeve to the tube.
- In order to obtain a curve of the tube as close to the tightening point as possible (fitting body), the structural constructing ties that are typical of the ORFS fittings must be considered. This product forces the user to leave a part of the ending section of the tube perfectly straight. This part must be used during the flaring operation to block the tube. Please refer to the table on page 218 "C" quote.

STAINLESS STEEL FITTINGS

- High quality tubes must be employed to assure correct use and related technical performance of stainless steel fittings. The use of tubes without the aforementioned characteristics may seriously impair the efficiency of the fitting. We recommend using the following tubes only: calibrated and polished, cold drawn seamless tubes 1.4571 as per UNI EN 10216-5 or ASTM A 269; the maximum permitted hardness, measured on the outer diameter of the tube, is 85 HRB.
- The flaring of the tube must be carried out with extreme care and precision. It is important that the flaring is concentric and perpendicular compared to the tube and sleeve.
- Brazing the tube must be carried out with suitable materials. It is important that the brazing is carried out in a way to ensure the perfect perpendicularity of the sleeve to the tube.
- In order to obtain a curve of the tube as close to the tightening point as possible (fitting body), the structural constructing ties that are typical of the ORFS fittings must be considered. This product forces the user to leave a part of the ending section of the tube perfectly straight. This part must be used during the flaring operation to block the tube. Please refer to the table on page 218 "C" quote.

ASSEMBLY INSTRUCTIONS ACCORDING TO SAE J1453 FOR FLARED TUBES

1. Before starting the tube flaring and assembly operations, please check that all the tools to be used are in perfect working order. Substitute those not complying to the requirements.
2. Cut the tube square by using an appropriate hack-saw (do not use roller type tube cutters). Check that the cut is properly made at 90°. Remove any internal and external burrs with the suitable deburring tool.
3. To obtain the desired length of the tube please add the L1 quote to the desired length of the tube in the table on page 218.
4. Check for any leakage line and other structural defects that may impair the seal of the fitting body. Reject any non complying tube.
5. Thoroughly clean the part of the tube to be flared and lubricate it with appropriate products.
6. Assemble the nut and sleeve on the tube as shown below, taking care that the open part of the nut faces the end of the tube to be flared; likewise, the end of the tube to be flared must face the greater diameter of the sleeve.
7. Flare the tube using the appropriate flaring machine, carefully respecting all the indications in the table on page 218.
8. Check that the flaring of the tube has been done correctly and that no peeling of the material appears inside it.
9. Clean the nut, fitting and tube and lubricate with the suggested products.
10. Couple the flared tube and tighten by hand the nut on the body of the fitting to check the correct alignment of the parts; using a wrench tighten until reaching the contact of the sealing surfaces and tighten according to the table (tightening torques of page 219).
11. Repeated assembly and disassembly will not alter the functionality of the system which, each time is closed, will always provide an immediate seal, which will last over time, guaranteeing the required seal.

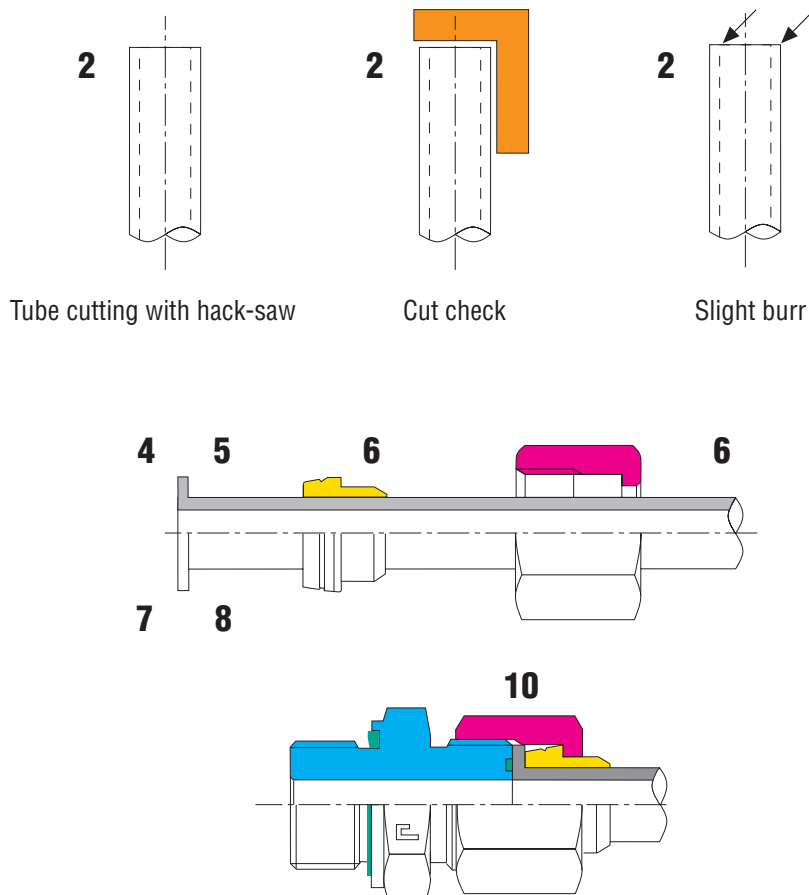

ASSEMBLY INSTRUCTIONS ACCORDING TO SAE J1453 FOR BRAZED TUBES

1. Before starting the tube brazing and assembly operations, please check that all the tools to be used are in perfect working order. Substitute those not complying to the requirements.
2. Cut the tube square by using an appropriate hack-saw (do not use roller type tube cutters). Check that the cut is properly made at 90°. Remove any internal and external burrs with the suitable deburring tool.
3. To obtain the desired length of the tube please subtract the L2 quote from the desired length of the tube in the table on page 218.
4. Check for any leakage line and other structural defects that may impair the seal of the fitting body. Reject any non complying tube.
5. Clean properly the sleeve and the part of the tube to be brazed.
6. Assemble the nut and sleeve on the tube taking care that the open part of the nut faces the end of the tube to be brazed and that the tube is inserted in the related groove obtained in the sleeve.
7. Then apply the mould on the tip of the tube making sure that the tube is completely in touch with the sleeve and carry out the brazing making sure not to overheat and carbonize the mould.
8. Clean the area where the brazing was carried out and check that the brazing seam is even along the entire external diameter of the tube.
9. Clean the nut, fitting and sleeve and lubricate with the suggested products.
10. Couple the brazed tube and tighten by hand the nut on the body of the fitting to check the correct alignment of the parts; using a wrench tighten until reaching the contact of the sealing surfaces and tighten according to the table (tightening torques of page 219).
11. Repeated assembly and disassembly will not alter the functionality of the system which, each time is closed, will always provide an immediate seal, which will last over time, guaranteeing the required seal.

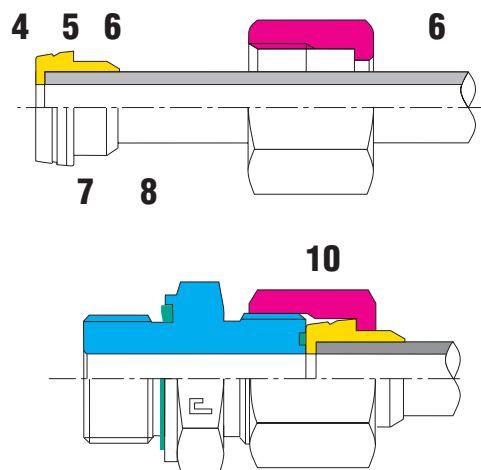
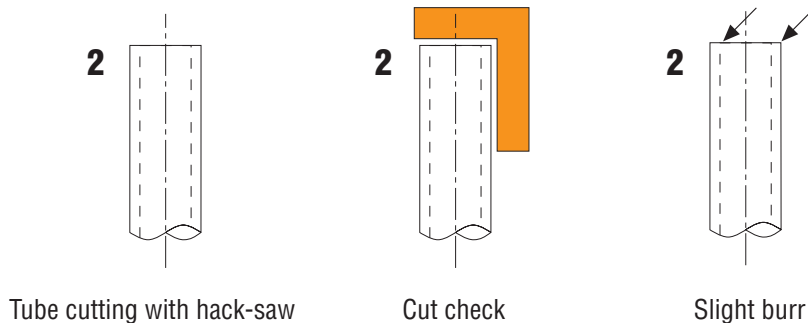

TECHNICAL DATA FOR THE PREPARATION OF FLARED AND BRAZED TUBES

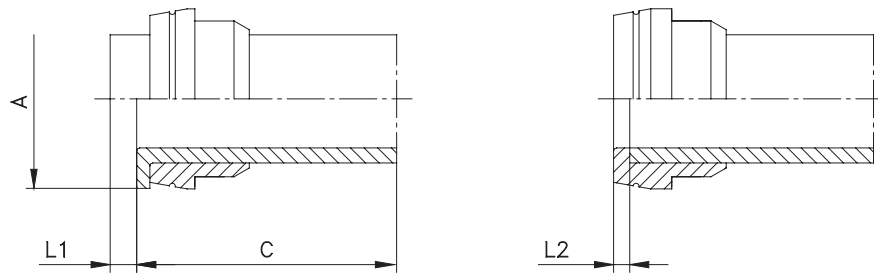

Ø tube Metric	Ø tube Inches	Ø flaring		L1	L2	C
		A min	A max			
6x1	1/4x0,035	12,10	12,75	-	1	32
6x1,5	1/4x0,065			-		
8x1	5/16x0,035	14,85	15,75	-	1	40
8x1,5	5/16x0,065			-		
10x1	3/8x0,035			2,5		
10x1,5	3/8x0,065	18	18,90	2	1	45
10x2	3/8x0,083			1,5		
12x1	1/2x0,035			-		
12x1,5	1/2x0,065	18	18,90	3	1	45
12x2	1/2x0,083			2,5		
12x2,5	1/2x0,095			2		
14x1,5	-			-		
14x2	-	22,20	23,45	-	1,5	45
14x2,5	-			-		
15x1,5	-			4,5		
15x2	-			4		
15x2,5	-			3,5		
16x1,5	5/8x0,065			4		
16x2	5/8x0,083			3,5		
16x2,5	5/8x0,095			3		
16x3	5/8x0,120			2,5		
18x1,5	-			26,60		
18x2	-	5				
18x2,5	-	4,5				
18x3	-	4				

Ø tube Metric	Ø tube Inches	Ø flaring		L1	L2	C
		A min	A max			
20x2	3/4x0,083	26,60	27,85	4	1,5	50
20x2,5	3/4x0,095			3,5		
20x3	3/4x0,120			3		
20x3,5	3/4x0,134			2,5		
22x2	7/8x0,083	32,95	34,20	-	1,5	60
22x2,5	7/8x0,095			-		
22x3	7/8x0,120			-		
25x2,5	1x0,095			4,5		
25x3	1x0,120			4		
25x4	1x0,156	39,35	40,55	3	1,5	60
25x5	1x0,188			2		
28x2	-			-		
28x2,5	-			-		
28x3	-			-		
30x2	-			5,5		
30x2,5	-			5		
30x3	-			4,5		
30x4	-			4		
32x3	1 1/4x0,120			4		
32x4	1 1/4x0,156	-				
35x3	-	47,25	48,50	-	1,5	70
35x4	-			-		
38x3	1 1/2x0,120			7		
38x4	1 1/2x0,156			6		

FUNCTIONALITY

- The correct execution of the flaring and brazing is an essential condition for the functionality of the seal of the coupling.
- It is necessary to be aware of the importance of preparing the tubes, and total precision in the process is required.
- The quality of the processed tubes is a guarantee of safe functionality, easy assembly and a system created simply with an excellent yield.

TIGHTENING TORQUES FOR TUBE ENDS

FLARED

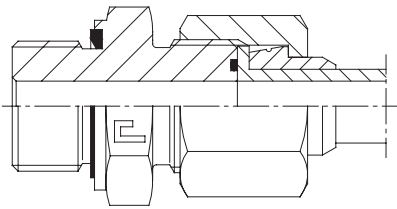

BRAZED

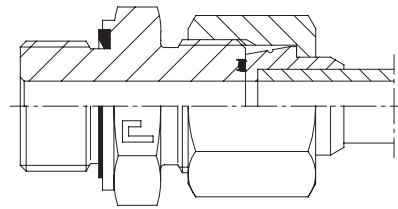

TIGHTENING TORQUES FOR STAPLED SEAM ENDS

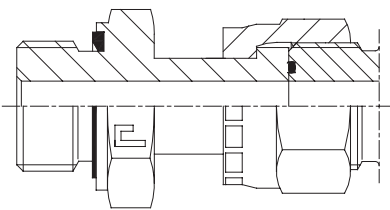

ASSEMBLY INSTRUCTIONS FOR FITTINGS WITH SWIVEL NUT

1. Before the assembly, check for the correct parameters of all the tools to be used and substitute those not complying to the requirements.
2. Clean the nut, fitting and tube and lubricate with the suggested products.
3. Check the correct alignment of the parts involved, then using a wrench tighten the stapled nut until reaching the contact of the seal surfaces and tighten according to the values of the table.
4. Repeated assembly and disassembly will not alter the functionality of the system which, each time is closed, will provide an immediate seal, which will last over time, guaranteeing the required seal.

Series	Ø tube Metric	Ø tube Inches	Thread UNF/UNS UN-2A	Tube side torque (Nm) ^{+10%} ₀	Stapled nut torque (Nm) ^{+10%} ₀
UNIVERSAL	6	1/4	9/16-18	25	25
	8-10	5/16-3/8	11/16-16	40	40
	12	1/2	13/16-16	55	55
	14-15-16	5/8	1-14	60	60
	18-20	3/4	1 3/16-12	90	90
	22-25	7/8-1	1 7/16-12	125	125
	28-30-32	1 1/4	1 11/16-12	170	170
	35-38	1 1/2	2-12	200	200

Notes:

The values in the tightening tables are approximate and derive from practical tests run at the laboratory in Casalgrasso (CN), which may vary based on the materials and tolerances of the components used.

All the values expressed in Newton Meters (Nm) for the tightening torques on the ORFS side tube represent the torquing moment, calculated on the maximum thickness of the utilisation tube, needed to obtain the correct tightness.

All the values expressed in Newton Meters (Nm) for the tightening torques on the ORFS stapled seam represent the torquing moment needed to obtain the correct tightness. The tightening torques indicated in the table refer to carbon steel fittings. For stainless steel fittings, use the tightening torque values at maximum tolerance.

SLEEVE

Type: 4001..

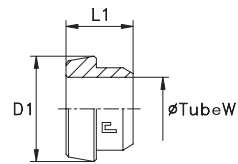
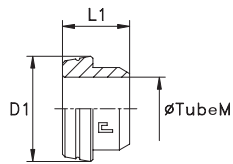

Series ORFS	40.... [bar]	41.... [bar]	Ordering metric Pipe	Ordering Inch Pipe	Ø Tube M	Ø Tube W	D1	L1
UNIVERSAL	630	630	400101	400101.W	6	1/4	12,75	7,5
			400102	400102.W	10	3/8	15,75	8,5
			400103	400103.W	12	1/2	18,9	10,5
	420	420	400104	400104.W	16	5/8	23,45	10,5
			400105	400105.W	20	3/4	27,85	12
			400106	400106.W	25	1	34,2	13,5
	280	280	400107	400107.W	30	1 1/4	40,55	13
			400108	400108.W	38	1 1/2	48,5	12,5
	630	630	400109	400109.W	8	5/16	15,75	8,5
	420	420	400110	-	14	-	23,45	10,5
			400111	-	15	-	23,45	10,5
			400112	-	18	-	27,85	12
			400113	400113.W	22	7/8	34,2	13,5
	280	280	400114	-	28	-	40,55	13
			400115	-	32	-	40,55	13
			400116	-	35	-	48,5	12,5

Notes: If you wish to order a fitting in stainless steel, please change the first two digit from 40.... to 41.... .

BRAZE SLEEVE

Type: 4002..

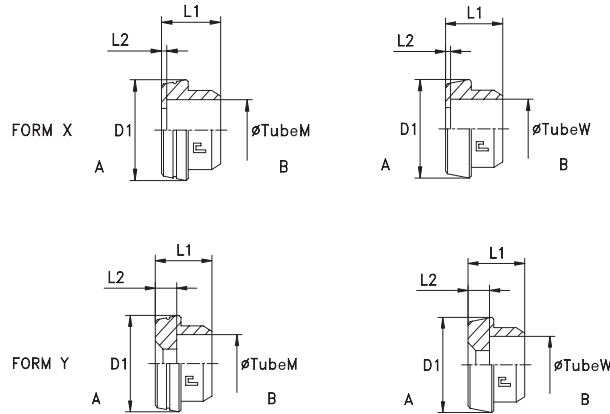

Series	40.... [bar]	41.... [bar]	Ordering metric Pipe	Ordering Inch Pipe	Ø Tube A ^M	Ø Tube B ^M	Ø Tube A ^W	Ø Tube B ^W	Form	D1	L1	L2	
UNIVERSAL	STANDARD	630	400201	400201.W	6	6	1/4	1/4	X	12,75	9,5	1	
			400202	400202.W	10	10	3/8	3/8	X	15,75	9,5	1	
			400203	400203.W	12	12	1/2	1/2	X	18,9	9,5	1	
		420	400204	400204.W	16	16	5/8	5/8	X	23,45	10,5	1,5	
			400205	400205.W	20	20	3/4	3/4	X	27,85	14	1,5	
			400206	400206.W	25	25	1	1	X	34,2	15,5	1,5	
		280	400207	400207.W	30	30	1 1/4	1 1/4	X	40,55	15,5	1,5	
			400208	400208.W	38	38	1 1/2	1 1/2	X	48,5	15,5	1,5	
		630	630	400209	400209.W	8	8	5/16	5/16	X	15,75	9,5	1
		420	420	400210	-	14	14	-	-	X	23,45	10,5	1,5
				400211	-	15	15	-	-	X	23,45	10,5	1,5
				400212	-	18	18	-	-	X	27,85	14	1,5
				400213	400213.W	22	22	7/8	7/8	X	34,2	15,5	1,5
				400214	-	28	28	-	-	X	40,55	15,5	1,5
				400215	-	32	32	-	-	X	40,55	15,5	1,5
	280	280	400216	-	35	35	-	-	X	48,5	15,5	1,5	
	JUMP SIZES	630	630	400217	400217.W	8-10	6	5/16-3/8	1/4	Y	15,75	10,5	2
				400218	400218.W	12	6	1/2	1/4	Y	18,9	12	3,5
				400219	400219.W	12	10	1/2	3/8	Y	18,9	12	3,5
		420	420	400220	400220.W	14-15-16	6	5/8	1/4	Y	23,45	13,5	5
				400221	400221.W	14-15-16	10	5/8	3/8	Y	23,45	13,5	5
				400222	400222.W	14-15-16	12	5/8	1/2	Y	23,45	13,5	5
				400223	400223.W	18-20	6	3/4	1/4	Y	27,85	14,5	6
				400224	400224.W	18-20	10	3/4	3/8	Y	27,85	14,5	6
				400225	400225.W	18-20	12	3/4	1/2	Y	27,85	14,5	6
				400226	400226.W	18-20	16	3/4	5/8	Y	27,85	14,5	5,5
				400227	400227.W	22-25	12	7/8-1	1/2	Y	34,2	15,5	7
				400228	400228.W	22-25	16	7/8-1	5/8	Y	34,2	15,5	6,5
				400229	400229.W	22-25	20	7/8-1	3/4	Y	34,2	17	4,5
		400230	400230.W	22-25	22	7/8-1	7/8	Y	34,2	17	3		
280		280	400231	400231.W	28-30-32	20	1 1/4	3/4	Y	40,55	19,5	7	
	400232		400232.W	28-30-32	25	1 1/4	1	Y	40,55	21	7		
	400233		400233.W	35-38	25	1 1/2	1	Y	48,5	21	7		
	400234		400234.W	35-38	30	1 1/2	1 1/4	Y	48,5	21	7		

Notes: If you wish to order a fitting in stainless steel, please change the first two digit from 40.... to 41....

NUT

Type: 4003..

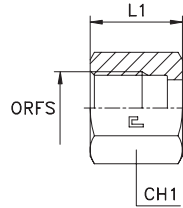

Series ORFS	40.... [bar]	41.... [bar]	Ordering Complete	Ø Tube M	Ø Tube W	ORFS	L1	CH1
UNIVERSAL	630	630	400301	6	1/4	9/16-18	15	17
			400302	8-10	5/16-3/8	11/16-16	17	22
			400303	12	1/2	13/16-16	20	24
	420	420	400304	14-15-16	5/8	1-14	24	30
			400305	18-20	3/4	13/16-12	26,5	36
			400306	22-25	7/8-1	17/16-12	27,5	41
	280	280	400307	28-30-32	1 1/4	1 11/16-12	27,5	50
			400308	35-38	1 1/2	2-12	27,5	60

Notes: If you wish to order AISI 316 stainless steel fittings, please change the first two digits from 40.... to 41....
If you wish to order AISI 304 stainless steel fittings, please change the first two digits from 40.... to 44....

MALE STUD COUPLING WITH ELASTOMER SEAL

Thread BSP Parallel

Type: 4004..

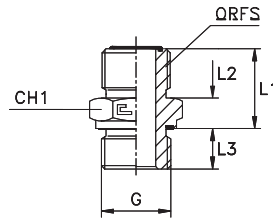

Series ORFS	40.... [bar]	41.... [bar]	Ordering Complete	Ø Tube M	Ø Tube W	G	L1	L2	L3	CH1	ORFS
UNIVERSAL	630	630	400401	6	1/4	1/8	17,5	10	8	17	9/16-18
			400402	8-10	5/16-3/8	1/4	20	11	12	19	11/16-16
			400403	12	1/2	3/8	22,5	13	12	22	13/16-16
	420	420	400404	14-15-16	5/8	1/2	27	15,5	14	27	1-14
			400405	18-20	3/4	3/4	30	17	16	32	13/16-12
			400406	22-25	7/8-1	1	32	17,5	18	41	17/16-12
	280	280	400407	28-30-32	1 1/4	1 1/4	34	17,5	20	50	11/16-12
			400408	35-38	1 1/2	1 1/2	35,5	17,5	22	55	2-12
	630	630	400409	6	1/4	1/4	19	10	12	19	9/16-18
			400410	6	1/4	3/8	19,5	10	12	22	9/16-18
			400411	6	1/4	1/2	21,5	10	14	27	9/16-18
			400412	8-10	5/16-3/8	1/8	19,5	11	8	19	11/16-16
			400413	8-10	5/16-3/8	3/8	20,5	11	12	22	11/16-16
			400414	8-10	5/16-3/8	1/2	22,5	11	14	27	11/16-16
	420	420	400415	8-10	5/16-3/8	3/4	24	11	16	32	11/16-16
	630	630	400416	12	1/2	1/4	22	13	12	22	13/16-16
			400417	12	1/2	1/2	24,5	13	14	27	13/16-16
	420	420	400418	12	1/2	3/4	26	13	16	32	13/16-16
			400419	14-15-16	5/8	1/4	26	15,5	12	27	1-14
			400420	14-15-16	5/8	3/8	26,5	15,5	12	27	1-14
			400421	14-15-16	5/8	3/4	28,5	15,5	16	32	1-14
			400422	14-15-16	5/8	1	30	15,5	18	41	1-14
			400423	18-20	3/4	1/4	29	17	12	32	13/16-12
			400424	18-20	3/4	1/2	30	17	14	32	13/16-12
			400425	18-20	3/4	1	31,5	17	18	41	13/16-12
			400426	18-20	3/4	1 1/4	33,5	17	20	50	13/16-12
			400427	22-25	7/8-1	1/4	31	17,5	12	41	17/16-12
			400428	22-25	7/8-1	3/4	32	17,5	16	41	17/16-12
	280	280	400429	22-25	7/8-1	1 1/4	34	17,5	20	50	17/16-12
			400430	22-25	7/8-1	1 1/2	35,5	17,5	22	55	17/16-12
			400431	28-30-32	1 1/4	1	34	17,5	18	46	11/16-12
			400432	28-30-32	1 1/4	1 1/2	35,5	17,5	22	55	11/16-12

Notes: If you wish to order a fitting in stainless steel, please change the first two digit from 40.... to 41....

MALE STUD COUPLING WITH ELASTOMER SEAL

Thread Metric Parallel

Type: **4005..**

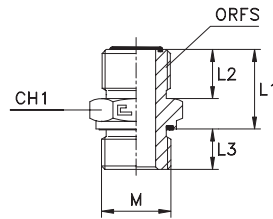

Series	40.... [bar]	41.... [bar]	Ordering Complete	Ø Tube M	Ø Tube W	M	L1	L2	L3	CH1	ORFS
UNIVERSAL	630	630	400501	6	1/4	12x1,5	18	10	12	17	9/16-18
			400502	8-10	5/16-3/8	14x1,5	20	11	12	19	11/16-16
			400503	12	1/2	18x1,5	22,5	13	12	24	13/16-16
	420	420	400504	14-15-16	5/8	22x1,5	27	15,5	14	27	1-14
			400505	18-20	3/4	27x2	30	17	16	32	13/16-12
			400506	22-25	7/8-1	33x2	32	17,5	18	41	17/16-12
	280	280	400507	28-30-32	1 1/4	42x2	34	17,5	20	50	11 1/16-12
			400508	35-38	1 1/2	48x2	35,5	17,5	22	55	2-12
	350	350	400509	6	1/4	10x1	17,5	10	8	17	9/16-18
			400510	6	1/4	14x1,5	19	10	12	19	9/16-18
	630	630	400511	8-10	5/16-3/8	12x1,5	20	11	12	19	11/16-16
			400512	8-10	5/16-3/8	16x1,5	20	11	12	22	11/16-16
			400513	8-10	5/16-3/8	18x1,5	20,5	11	12	24	11/16-16
			400514	12	1/2	14x1,5	22	13	12	22	13/16-16
			400515	12	1/2	16x1,5	22,5	13	12	22	13/16-16
			400516	12	1/2	22x1,5	24,5	13	14	27	13/16-16
	420	420	400517	14-15-16	5/8	18x1,5	26,5	15,5	12	27	1-14
			400518	14-15-16	5/8	27x2	28,5	15,5	16	32	1-14
			400519	18-20	3/4	22x1,5	30	17	14	32	13/16-12
			400520	18-20	3/4	33x2	31,5	17	18	41	13/16-12
			400521	22-25	7/8-1	27x2	32	17,5	16	41	17/16-12
			400522	22-25	7/8-1	42x2	34	17,5	20	50	17/16-12
	280	280	400523	28-30-32	1 1/4	33x2	34	17,5	18	46	11 1/16-12
			400524	28-30-32	1 1/4	48x2	35,5	17,5	22	55	11 1/16-12

Notes: If you wish to order a fitting in stainless steel, please change the first two digit from **40....** to **41....** .

MALE STUD COUPLING WITH O-RING

Thread UNF/UN-2A

Type: 4006..

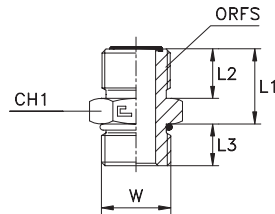

Series ORFS	40.... [bar]	41.... [bar]	Ordering Complete	Ø Tube M	Ø Tube W	W	L1	L2	L3	CH1	ORFS
UNIVERSAL	630	630	400601	6	1/4	7/16-20	18	10	11	17	9/16-18
			400602	8-10	5/16-3/8	9/16-18	20	11	12	19	11/16-16
			400603	12	1/2	3/4-16	22,5	13	14	22	13/16-16
	420	420	400604	14-15-16	5/8	7/8-14	27	15,5	16	27	1-14
			400605	18-20	3/4	1 1/16-12	30	17	18,5	32	13/16-12
			400606	22-25	7/8-1	1 5/16-12	32	17,5	18,5	41	17/16-12
	280	280	400607	28-30-32	1 1/4	1 5/8-12	33,5	17,5	18,5	46	1 1/16-12
			400608	35-38	1 1/2	1 7/8-12	35,5	17,5	18,5	55	2-12
	630	630	400609	6	1/4	1/2-20	18	10	11	17	9/16-18
			400610	6	1/4	9/16-18	18	10	12	19	9/16-18
			400611	6	1/4	3/4-16	19,5	10	14	22	9/16-18
			400612	8-10	5/16-3/8	7/16-20	20	11	11	19	11/16-16
			400613	8-10	5/16-3/8	1/2-20	20	11	11	19	11/16-16
			400614	8-10	5/16-3/8	3/4-16	20,5	11	14	22	11/16-16
	420	420	400615	8-10	5/16-3/8	7/8-14	22,5	11	16	27	11/16-16
			400616	8-10	5/16-3/8	1 1/16-12	24	11	18,5	32	11/16-16
	630	630	400617	12	1/2	9/16-18	22,5	13	12	22	13/16-16
			400618	12	1/2	7/8-14	24,5	13	16	27	13/16-16
	420	420	400619	12	1/2	1 1/16-12	26	13	18,5	32	13/16-16
			400620	12	1/2	1 5/16-12	27,5	13	18,5	41	13/16-16
			400621	14-15-16	5/8	3/4-16	27	15,5	14	27	1-14
			400622	14-15-16	5/8	1 1/16-12	28,5	15,5	18,5	32	1-14
			400623	18-20	3/4	3/4-16	30	17	14	32	13/16-12
			400624	18-20	3/4	7/8-14	30	17	16	32	13/16-12
			400625	18-20	3/4	1 5/16-12	31,5	17	18,5	41	13/16-12
	280	280	400626	22-25	7/8-1	1 1/16-12	32	17,5	18,5	41	17/16-12
			400627	22-25	7/8-1	1 5/8-12	33,5	17,5	18,5	46	17/16-12
			400628	28-30-32	1 1/4	1 5/16-12	33,5	17,5	18,5	46	1 1/16-12
			400629	28-30-32	1 1/4	1 7/8-12	35,5	17,5	18,5	55	1 1/16-12
				400630	35-38	1 1/2	1 5/8-12	35,5	17,5	18,5	55

Notes: If you wish to order a fitting in stainless steel, please change the first two digit from 40.... to 41.... .

MALE STUD COUPLING WITH O-RING AND WASHER

Thread BSP Parallel

Type: 4007..

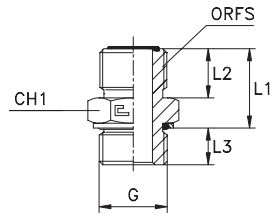

Series ORFS	40.... [bar]	41.... [bar]	Ordering Complete	Ø Tube M	Ø Tube W	G	L1	L2	L3	CH1	ORFS
UNIVERSAL	350	350	400701	6	1/4	1/8	18,8	10	6,7	17	9/16-18
	400	400	400702	8-10	5/16-3/8	1/4	21,8	11	10,2	19	11/16-16
	350	350	400703	12	1/2	3/8	24,3	13	10,2	22	13/16-16
	315	315	400704	14-15-16	5/8	1/2	28,8	15,5	12,2	27	1-14
			400705	18-20	3/4	3/4	31,8	17	12,7	36	13/16-12
	280	280	400706	22-25	7/8-1	1	34,6	17,5	15,4	41	17/16-12
			400707	28-30-32	1 1/4	1 1/4	36,5	17,5	16	50	111/16-12
	250	250	400708	35-38	1 1/2	1 1/2	38	17,5	16	55	2-12
	400	400	400709	6	1/4	1/4	20,8	10	10,2	19	9/16-18
	350	350	400710	6	1/4	3/8	21,3	10	10,2	22	9/16-18
	315	315	400711	6	1/4	1/2	23,3	10	12,2	27	9/16-18
	350	350	400712	8-10	5/16-3/8	1/8	20,8	11	6,7	19	11/16-16
			400713	8-10	5/16-3/8	3/8	22,3	11	10,2	22	11/16-16
	315	315	400714	8-10	5/16-3/8	1/2	24,3	11	12,2	27	11/16-16
			400715	8-10	5/16-3/8	3/4	25,8	11	12,7	36	11/16-16
	400	400	400716	12	1/2	1/4	24,8	13	10,2	22	13/16-16
	315	315	400717	12	1/2	1/2	26,3	13	12,2	27	13/16-16
			400718	12	1/2	3/4	27,8	13	12,7	36	13/16-16
	400	400	400719	14-15-16	5/8	1/4	27,8	15,5	10,2	27	1-14
	350	350	400720	14-15-16	5/8	3/8	28,3	15,5	10,2	27	1-14
	315	315	400721	14-15-16	5/8	3/4	30,3	15,5	12,7	36	1-14
	280	280	400722	14-15-16	5/8	1	32,6	15,5	15,4	41	1-14
	400	400	400723	18-20	3/4	1/4	30,8	17	10,2	32	13/16-12
	315	315	400724	18-20	3/4	1/2	31,8	17	12,2	32	13/16-12
			400725	18-20	3/4	1	34,1	17	15,4	41	13/16-12
	200	200	400726	18-20	3/4	1 1/4	36	17	16	50	13/16-12
			400727	22-25	7/8-1	1/4	32,8	17,5	10,2	41	17/16-12
	315	315	400728	22-25	7/8-1	3/4	33,8	17,5	12,7	41	17/16-12
	280	280	400729	22-25	7/8-1	1 1/4	36,5	17,5	16	50	17/16-12
	250	250	400730	22-25	7/8-1	1 1/2	38	17,5	16	55	17/16-12
	280	280	400731	28-30-32	1 1/4	1	36,6	17,5	15,4	46	111/16-12
	250	250	400732	28-30-32	1 1/4	1 1/2	38	17,5	16	55	111/16-12

Notes: If you wish to order a fitting in stainless steel, please change the first two digit from 40.... to 41.... .

MALE STUD COUPLING WITH O-RING AND WASHER

Thread Metric Parallel

Type: 4008..

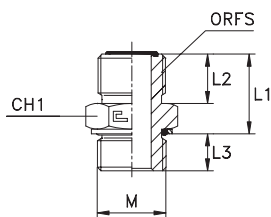

MALE STUD COUPLING

Thread NPTF

Type: 4009..

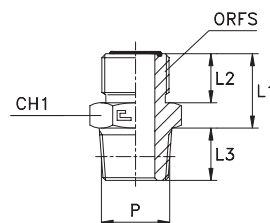

Series ORFS	40.... [bar]	41.... [bar]	Ordering Complete	Ø Tube M	Ø Tube W	M	L1	L2	L3	CH1	ORFS
UNIVERSAL	400	400	400801	6	1/4	12x1,5	18,9	10	9,6	17	9/16-18
			400802	8-10	5/16-3/8	14x1,5	21,4	11	9,6	19	11/16-16
			400803	12	1/2	18x1,5	25,4	13	12,6	24	13/16-16
	315	315	400804	14-15-16	5/8	22x1,5	28,4	15,5	13,6	27	1-14
			400805	18-20	3/4	27x2	32	17	16,5	32	13/16-12
	280	280	400806	22-25	7/8-1	33x2	35,5	17,5	16,5	41	17/16-12
			400807	28-30-32	1 1/4	42x2	37,5	17,5	17	50	11/16-12
	250	250	400808	35-38	1 1/2	48x2	37,5	17,5	19,5	55	2-12
	400	400	400809	6	1/4	10x1	19	10	8,5	17	9/16-18
			400810	6	1/4	14x1,5	20,4	10	9,6	19	9/16-18
			400811	8-10	5/16-3/8	12x1,5	21,4	11	9,6	19	11/16-16
			400812	8-10	5/16-3/8	16x1,5	22,4	11	11,1	22	11/16-16
			400813	8-10	5/16-3/8	18x1,5	23,4	11	12,6	24	11/16-16
			400814	12	1/2	14x1,5	24,4	13	9,6	22	13/16-16
			400815	12	1/2	16x1,5	24,4	13	11,1	22	13/16-16
			400816	12	1/2	22x1,5	25,9	13	13,6	27	13/16-16
	400	400	400817	14-15-16	5/8	18x1,5	28,4	15,5	12,6	27	1-14
	315	315	400818	14-15-16	5/8	27x2	30,5	15,5	16,5	32	1-14
			400819	18-20	3/4	22x1,5	31,4	17	13,6	32	13/16-12
	280	280	400820	18-20	3/4	33x2	35	17	16,5	41	13/16-12
	315	315	400821	22-25	7/8-1	27x2	35,5	17,5	16,5	41	17/16-12
	280	280	400822	22-25	7/8-1	42x2	37,5	17,5	17	50	17/16-12
			400823	28-30-32	1 1/4	33x2	37,5	17,5	16,5	46	11/16-12
	250	250	400824	28-30-32	1 1/4	48x2	37,5	17,5	19,5	55	11/16-12

Notes: If you wish to order a fitting in stainless steel, please change the first two digit from 40.... to 41....

Series ORFS	40.... [bar]	41.... [bar]	Ordering Complete	Ø Tube M	Ø Tube W	P	L1	L2	L3	CH1	ORFS
UNIVERSAL	420	420	400901	6	1/4	1/8	17,5	10	10	17	9/16-18
			400902	8-10	5/16-3/8	1/4	20	11	14,5	19	11/16-16
			400903	12	1/2	3/8	22,5	13	14,5	22	13/16-16
	420	420	400904	14-15-16	5/8	1/2	27	15,5	19	27	1-14
			400905	18-20	3/4	3/4	30	17	19	32	13/16-12
			400906	22-25	7/8-1	1	32	17,5	24	41	17/16-12
	280	280	400907	28-30-32	1 1/4	1 1/4	34	17,5	25	46	11/16-12
			400908	35-38	1 1/2	1 1/2	35,5	17,5	26	55	2-12
	630	630	400909	6	1/4	1/4	17,5	10	14,5	17	9/16-18
			400910	6	1/4	3/8	17,5	10	14,5	17	9/16-18
			400911	8-10	5/16-3/8	3/8	20	11	14,5	19	11/16-16
			400912	8-10	5/16-3/8	1/2	20,5	11	19	22	11/16-16
			400913	12	1/2	1/4	22,5	13	14,5	22	13/16-16
			400914	12	1/2	1/2	22,5	13	19	22	13/16-16
	420	420	400915	12	1/2	3/4	24,5	13	19	27	13/16-16
			400916	14-15-16	5/8	3/8	27	15,5	14,5	27	1-14
			400917	14-15-16	5/8	3/4	27	15,5	19	27	1-14
			400918	18-20	3/4	1/2	30	17	19	32	13/16-12
			400919	18-20	3/4	1	30	17	24	36	13/16-12
			400920	22-25	7/8-1	3/4	32	17,5	19	41	17/16-12
	280	280	400921	28-30-32	1 1/4	1	34	17,5	24	46	11/16-12
			400922	35-38	1 1/2	1 1/4	35,5	17,5	25	55	2-12

Notes: If you wish to order a fitting in stainless steel, please change the first two digit from 40.... to 41....

FEMALE STUD COUPLING

Thread BSP Parallel

Type: 4010..

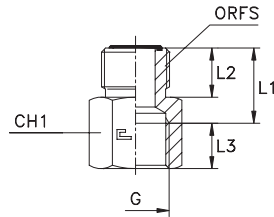

Series ORFS	40.... [bar]	41.... [bar]	Ordering Complete	Ø Tube M	Ø Tube W	G	L1	L2	L3	CH1	ORFS
UNIVERSAL	400	400	401001	6	1/4	1/4	17	10	14	19	9/16-18
			401002	8-10	5/16-3/8	1/4	18	11	14	19	11/16-16
			401003	12	1/2	3/8	21	13	14	24	13/16-16
			401004	14-15-16	5/8	1/2	24,5	15,5	17	30	1-14
	315	315	401005	18-20	3/4	3/4	27	17	19	36	13/16-12
			401006	22-25	7/8-1	1	27	17,5	21,5	41	17/16-12
	280	280	401007	28-30-32	1 1/4	1 1/4	30	17,5	23,5	55	1 11/16-12
	250	250	401008	35-38	1 1/2	1 1/2	30	17,5	25,5	60	2-12
	400	400	401009	12	1/2	1/4	20	13	14	22	13/16-16
			401010	18-20	3/4	1/2	26	17	17	32	13/16-12

Notes: If you wish to order a fitting in stainless steel, please change the first two digit from 40.... to 41.... .

FEMALE STUD COUPLING

Thread NPTF

Type: 4011..

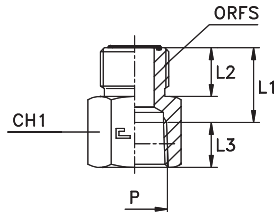

Series ORFS	40.... [bar]	41.... [bar]	Ordering Complete	Ø Tube M	Ø Tube W	P	L1	L2	L3	CH1	ORFS
UNIVERSAL	400	400	401101	6	1/4	1/4	17,5	10	14	19	9/16-18
			401102	8-10	5/16-3/8	1/4	18,5	11	14	19	11/16-16
			401103	12	1/2	3/8	21,5	13	14,5	24	13/16-16
			401104	14-15-16	5/8	1/2	25	15,5	19	30	1-14
	315	315	401105	18-20	3/4	3/4	27,5	17	19,5	36	13/16-12
			401106	22-25	7/8-1	1	30,5	17,5	23,5	41	17/16-12
	280	280	401107	28-30-32	1 1/4	1 1/4	32,5	17,5	24	55	1 11/16-12
	250	250	401108	35-38	1 1/2	1 1/2	32,5	17,5	24	60	2-12
	400	400	401109	12	1/2	1/4	20,5	13	14	22	13/16-16
			401110	18-20	3/4	1/2	26,5	17	19	32	13/16-12

Notes: If you wish to order a fitting in stainless steel, please change the first two digit from 40.... to 41.... .

LONG MALE STUD COUPLING WITH O-RING AND WASHER

Thread BSP Parallel

Type: 4012..

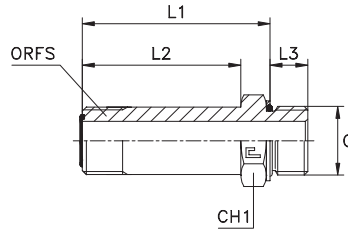

Series ORFS	40.... [bar]	41.... [bar]	Ordering Complete	Ø Tube M	Ø Tube W	G	L1	L2	L3	CH1	ORFS
UNIVERSAL	350	350	401201	6	1/4	1/8	42,3	33,5	6,7	17	9/16-18
	400	400	401202	8-10	5/16-3/8	1/4	47,8	37	10,2	19	11/16-16
	350	350	401203	12	1/2	3/8	55,8	44,5	10,2	22	13/16-16
	315	315	401204	14-15-16	5/8	1/2	65,8	52,5	12,2	27	1-14
			401205	18-20	3/4	3/4	78,8	64	12,7	36	13/16-12
	280	280	401206	22-25	7/8-1	1	90,1	73	15,4	41	17/16-12
			401207	28-30-32	1 1/4	1 1/4	105,5	86,5	16	50	111/16-12
	250	250	401208	35-38	1 1/2	1 1/2	117,5	97	16	55	2-12
	400	400	401209	6	1/4	1/4	44,3	33,5	10,2	19	9/16-18
	350	350	401210	6	1/4	3/8	44,8	33,5	10,2	22	9/16-18
			401211	8-10	5/16-3/8	3/8	48,3	37	10,2	22	11/16-16
	315	315	401212	8-10	5/16-3/8	1/2	50,3	37	12,2	27	11/16-16
	400	400	401213	12	1/2	1/4	56,3	44,5	10,2	22	13/16-16
	315	315	401214	12	1/2	1/2	57,8	44,5	12,2	27	13/16-16
			401215	12	1/2	3/4	59,3	44,5	12,7	36	13/16-16
	350	350	401216	14-15-16	5/8	3/8	65,3	52,5	10,2	27	1-14
	315	315	401217	14-15-16	5/8	3/4	67,3	52,5	12,7	36	1-14
			401218	18-20	3/4	1/2	78,8	64	12,2	32	13/16-12
	200	200	401219	18-20	3/4	1	81,1	64	15,4	41	13/16-12
			401220	18-20	3/4	1 1/4	83	64	16	50	13/16-12
	315	315	401221	22-25	7/8-1	3/4	89,3	73	12,7	41	17/16-12
	280	280	401222	22-25	7/8-1	1 1/4	92	73	16	50	17/16-12
			401223	28-30-32	1 1/4	1	105,6	86,5	15,4	46	111/16-12

Notes: If you wish to order a fitting in stainless steel, please change the first two digit from 40.... to 41.... .

FEMALE BULKHEAD CONNECTION

Thread BSP Parallel

Type: 4015..

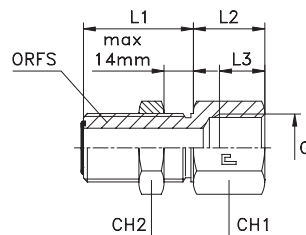

Series ORFS	40.... [bar]	41.... [bar]	Ordering Complete	Ø Tube M	Ø Tube W	G	L1	L2	L3	CH1	CH2	ORFS
UNIVERSAL	400	400	401501	6	1/4	1/4	31,5	21	14	22	22	9/16-18
			401502	8-10	5/16-3/8	1/4	34	21	14	27	27	11/16-16
			401503	12	1/2	3/8	36,5	22	14	30	30	13/16-16
			401504	14-15-16	5/8	1/2	40,5	26	17	36	36	1-14
			401505	18-20	3/4	3/4	41,5	29	19	41	41	13/16-12
	315	315	401506	22-25	7/8-1	1	42	31	21,5	46	46	17/16-12
	280	280	401507	28-30-32	1 1/4	1 1/4	42	36	23,5	55	50	111/16-12
	250	250	401508	35-38	1 1/2	1 1/2	42	38	25,5	60	60	2-12

Notes: If you wish to order a fitting in stainless steel, please change the first two digit from 40.... to 41.... .

STRAIGHT COUPLING

Type: 4017..

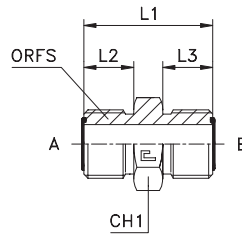

Series ORFS	40.... [bar]	41.... [bar]	Ordering Complete	Ø Tube A ^M	Ø Tube B ^M	Ø Tube A ^W	Ø Tube B ^W	L1	L2	L3	CH1	ORFS A	ORFS B
UNIVERSAL	630	630	401701	6	6	1/4	1/4	27,5	10	10	17	9/16-18	9/16-18
			401702	8-10	8-10	5/16-3/8	5/16-3/8	31	11	11	19	11/16-16	11/16-16
			401703	12	12	1/2	1/2	35,5	13	13	22	13/16-16	13/16-16
	420	420	401704	14-15-16	14-15-16	5/8	5/8	42,5	15,5	15,5	27	1-14	1-14
			401705	18-20	18-20	3/4	3/4	47	17	17	32	13/16-12	13/16-12
			401706	22-25	22-25	7/8-1	7/8-1	49,5	17,5	17,5	41	17/16-12	17/16-12
	280	280	401707	28-30-32	28-30-32	1 1/4	1 1/4	51,5	17,5	17,5	46	111/16-12	111/16-12
			401708	35-38	35-38	1 1/2	1 1/2	53	17,5	17,5	55	2-12	2-12
	630	630	401709	8-10	6	5/16-3/8	1/4	30	11	10	19	11/16-16	9/16-18
			401710	12	8-10	1/2	5/16-3/8	33,5	13	11	22	13/16-16	11/16-16
	420	420	401711	14-15-16	12	5/8	1/2	40	15,5	13	27	1-14	13/16-16
			401712	18-20	8-10	3/4	5/16-3/8	41	17	11	32	13/16-12	11/16-16
			401713	18-20	12	3/4	1/2	43	17	13	32	13/16-12	13/16-16
			401714	18-20	14-15-16	3/4	5/8	45,5	17	15,5	32	13/16-12	1-14
			401715	22-25	18-20	7/8-1	3/4	49	17,5	17	41	17/16-12	13/16-12
	280	280	401716	28-30-32	22-25	1 1/4	7/8-1	51,5	17,5	17,5	46	111/16-12	17/16-12

Notes: If you wish to order a fitting in stainless steel, please change the first two digit from 40.... to 41....

BULKHEAD STRAIGHT CONNECTION

Type: 4018..

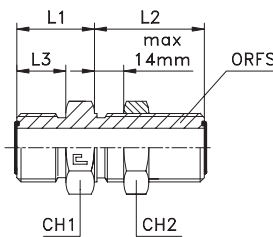

Series ORFS	40.... [bar]	41.... [bar]	Ordering Complete	Ø Tube M	Ø Tube W	L1	L2	L3	CH1	CH2	ORFS
UNIVERSAL	630	630	401801	6	1/4	16,5	31,5	10	22	22	9/16-18
			401802	8-10	5/16-3/8	19	34	11	27	27	11/16-16
			401803	12	1/2	22	36,5	13	30	30	13/16-16
	420	420	401804	14-15-16	5/8	26	40,5	15,5	36	36	1-14
			401805	18-20	3/4	27,5	41,5	17	41	41	13/16-12
	280	280	401806	22-25	7/8-1	28	42	17,5	46	46	17/16-12
			401807	28-30-32	1 1/4	28	42	17,5	50	50	111/16-12
			401808	35-38	1 1/2	28	42	17,5	60	60	2-12

Notes: If you wish to order a fitting in stainless steel, please change the first two digit from 40.... to 41....

STRAIGHT INTERMEDIATE REDUCTION

Type: 4019..

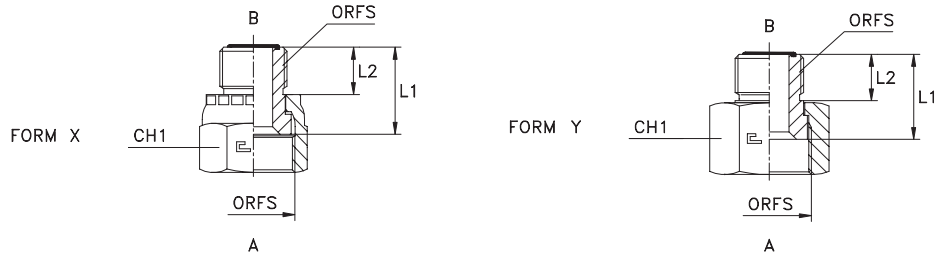

Series	40.... ORFS [bar]	41.... [bar]	Ordering Complete	Ø Tube A ^M	Ø Tube B ^M	Ø Tube A ^W	Ø Tube B ^W	Form	L1	L2	CH1	ORFS A	ORFS B
UNIVERSAL	630	630	401901	8-10	6	5/16-3/8	1/4	X	20	10	22	11/16-16	9/16-18
			401902	12	6	1/2	1/4	Y	22	10	24	13/16-16	9/16-18
	420	420	401903	14-15-16	6	5/8	1/4	Y	23	10	30	1-14	9/16-18
			401904	18-20	6	3/4	1/4	Y	25	10	36	13/16-12	9/16-18
			401905	22-25	6	7/8-1	1/4	Y	26	10	41	17/16-12	9/16-18
	280	280	401906	28-30-32	6	1 1/4	1/4	Y	26,5	10	50	11/16-12	9/16-18
			401907	35-38	6	1 1/2	1/4	Y	26,5	10	60	2-12	9/16-18
	630	630	401908	12	8-10	1/2	5/16-3/8	X	23	11	24	13/16-16	11/16-16
			401909	14-15-16	8-10	5/8	5/16-3/8	Y	24	11	30	1-14	11/16-16
	420	420	401910	18-20	8-10	3/4	5/16-3/8	Y	26	11	36	13/16-12	11/16-16
			401911	22-25	8-10	7/8-1	5/16-3/8	Y	27	11	41	17/16-12	11/16-16
			401912	28-30-32	8-10	1 1/4	5/16-3/8	Y	27,5	11	50	11/16-12	11/16-16
	280	280	401913	35-38	8-10	1 1/2	5/16-3/8	Y	27,5	11	60	2-12	11/16-16
			401914	14-15-16	12	5/8	1/2	Y	25,5	13	30	1-14	13/16-16
	420	420	401915	18-20	12	3/4	1/2	Y	27,5	13	36	13/16-12	13/16-16
			401916	22-25	12	7/8-1	1/2	Y	29	13	41	17/16-12	13/16-16
			401917	28-30-32	12	1 1/4	1/2	Y	29,5	13	50	11/16-12	13/16-16
	280	280	401918	35-38	12	1 1/2	1/2	Y	29,5	13	60	2-12	13/16-16
			401919	18-20	14-15-16	3/4	5/8	X	29,5	15,5	36	13/16-12	1-14
	420	420	401920	22-25	14-15-16	7/8-1	5/8	Y	32	15,5	41	17/16-12	1-14
			401921	28-30-32	14-15-16	1 1/4	5/8	Y	32	15,5	50	11/16-12	1-14
	280	280	401922	35-38	14-15-16	1 1/2	5/8	Y	32	15,5	60	2-12	1-14
			401923	22-25	18-20	7/8-1	3/4	X	33	17	46	17/16-12	13/16-12
	280	280	401924	28-30-32	18-20	1 1/4	3/4	Y	33,5	17	50	11/16-12	13/16-12
			401925	35-38	18-20	1 1/2	3/4	Y	33,5	17	60	2-12	13/16-12
			401926	28-30-32	22-25	1 1/4	7/8-1	X	34	17,5	50	11/16-12	17/16-12
			401927	35-38	22-25	1 1/2	7/8-1	Y	34	17,5	60	2-12	17/16-12
			401928	35-38	28-30-32	1 1/2	1 1/4	Y	34	17,5	60	2-12	11/16-12

Notes: If you wish to order a fitting in stainless steel, please change the first two digit from 40.... to 41.... .

If you wish to order AISI 316 form Y stainless steel fittings with AISI 304 stainless steel nuts, please change the first two digits from 40.... to 44.... .

WELDABLE STRAIGHT FEMALE

Type: 4020..

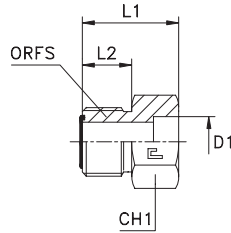

Series ORFS	40.... [bar]	41.... [bar]	Ordering metric Pipe	Ordering Inch Pipe	Ø Tube M	Ø Tube W	D1 ^m	D1 ^w	L1	L2	CH1	ORFS
UNIVERSAL	630	630	402001	402001.W	6	1/4	6	1/4	22	10	17	9/16-18
			402002	402002.W	8-10	5/16-3/8	10	3/8	23	11	19	11/16-16
			402003	402003.W	12	1/2	12	1/2	24,5	13	22	13/16-16
	420	420	402004	402004.W	14-15-16	5/8	16	5/8	28	15,5	27	1-14
			402005	402005.W	18-20	3/4	20	3/4	33,5	17	32	13/16-12
			402006	402006.W	22-25	7/8-1	25	1	38,5	17,5	41	17/16-12
	280	280	402007	402007.W	28-30-32	1 1/4	30	1 1/4	38,5	17,5	46	11 1/16-12
			402008	402008.W	35-38	1 1/2	38	1 1/2	38,5	17,5	55	2-12
	630	630	402009	402009.W	6	1/4	8	5/16	22	10	17	9/16-18
			402010	402010.W	6	1/4	10	3/8	22	10	17	9/16-18
			402011	402011.W	6	1/4	12	1/2	22	10	19	9/16-18
			402012	402012.W	8-10	5/16-3/8	6	1/4	23	11	19	11/16-16
			402013	402013.W	8-10	5/16-3/8	8	5/16	23	11	19	11/16-16
			402014	402014.W	8-10	5/16-3/8	12	1/2	23	11	19	11/16-16
	420	420	402015	-	8-10	5/16-3/8	14	-	23,5	11	22	11/16-16
			402016	-	8-10	5/16-3/8	15	-	23,5	11	22	11/16-16
			402017	402017.W	8-10	5/16-3/8	16	5/8	23,5	11	22	11/16-16
	630	630	402018	402018.W	12	1/2	6	1/4	24,5	13	22	13/16-16
			402019	402019.W	12	1/2	8	5/16	24,5	13	22	13/16-16
			402020	402020.W	12	1/2	10	3/8	24,5	13	22	13/16-16
	420	420	402021	-	12	1/2	14	-	25	13	22	13/16-16
			402022	-	12	1/2	15	-	25	13	22	13/16-16
			402023	402023.W	12	1/2	16	5/8	25	13	22	13/16-16
			402024	-	12	1/2	18	-	29	13	27	13/16-16
			402025	402025.W	12	1/2	20	3/4	29	13	27	13/16-16
			402026	402026.W	12	1/2	22	7/8	29,5	13	32	13/16-16
			402027	402027.W	12	1/2	25	1	31	13	32	13/16-16
			402028	402028.W	14-15-16	5/8	10	3/8	27,5	15,5	27	1-14
			402029	402029.W	14-15-16	5/8	12	1/2	27,5	15,5	27	1-14
			402030	-	14-15-16	5/8	14	-	28	15,5	27	1-14
			402031	-	14-15-16	5/8	15	-	28	15,5	27	1-14
			402032	-	14-15-16	5/8	18	-	31,5	15,5	27	1-14
			402033	402033.W	14-15-16	5/8	20	3/4	31,5	15,5	27	1-14
			402034	402034.W	18-20	3/4	12	1/2	29,5	17	32	13/16-12
			402035	-	18-20	3/4	14	-	30	17	32	13/16-12
			402036	-	18-20	3/4	15	-	30	17	32	13/16-12
			402037	402037.W	18-20	3/4	16	5/8	30	17	32	13/16-12
			402038	-	18-20	3/4	18	-	33,5	17	32	13/16-12
			402039	402039.W	18-20	3/4	22	7/8	33,5	17	32	13/16-12
			402040	402040.W	18-20	3/4	25	1	35	17	32	13/16-12
			402041	402041.W	22-25	7/8-1	12	1/2	33	17,5	41	17/16-12
			402042	-	22-25	7/8-1	14	-	33,5	17,5	41	17/16-12
			402043	-	22-25	7/8-1	15	-	33,5	17,5	41	17/16-12
			402044	402044.W	22-25	7/8-1	16	5/8	33,5	17,5	41	17/16-12
			402045	-	22-25	7/8-1	18	-	37	17,5	41	17/16-12
			402046	402046.W	22-25	7/8-1	20	3/4	37	17,5	41	17/16-12
			402047	402047.W	22-25	7/8-1	22	7/8	37	17,5	41	17/16-12
	280	280	402048	-	22-25	7/8-1	28	-	38,5	17,5	41	17/16-12
			402049	402049.W	22-25	7/8-1	30	1 1/4	38,5	17,5	41	17/16-12
			402050	-	22-25	7/8-1	32	-	38,5	17,5	41	17/16-12

Notes: If you wish to order a fitting in stainless steel, please change the first two digit from 40.... to 41....

WELDABLE STRAIGHT FEMALE

Type: 4020..

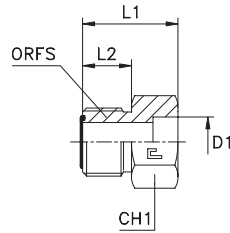

Series ORFS	40.... [bar]	41.... [bar]	Ordering metric Pipe	Ordering Inch Pipe	Ø Tube M	Ø Tube W	D1 ^M	D1 ^W	L1	L2	CH1	ORFS
UNIVERSAL	280	280	402051	-	28-30-32	1/4	18	-	37	17,5	46	11/16-12
			402052	402052.W	28-30-32	1/4	20	3/4	37	17,5	46	11/16-12
			402053	402053.W	28-30-32	1/4	22	7/8	37	17,5	46	11/16-12
			402054	402054.W	28-30-32	1/4	25	1	38,5	17,5	46	11/16-12
			402055	-	28-30-32	1/4	28	-	38,5	17,5	46	11/16-12
			402056	-	28-30-32	1/4	32	-	38,5	17,5	46	11/16-12
			402057	-	28-30-32	1/4	35	-	38,5	17,5	50	11/16-12
			402058	402058.W	28-30-32	1/4	38	1/2	38,5	17,5	50	11/16-12
			402059	402059.W	35-38	1/2	25	1	38,5	17,5	55	2-12
			402060	-	35-38	1/2	28	-	38,5	17,5	55	2-12
			402061	402061.W	35-38	1/2	30	1/4	38,5	17,5	55	2-12
			402062	-	35-38	1/2	32	-	38,5	17,5	55	2-12
			402063	-	35-38	1/2	35	-	38,5	17,5	55	2-12

Notes: If you wish to order a fitting in stainless steel, please change the first two digit from 40.... to 41.... .

WELDING NIPPLE

Type: 4021..

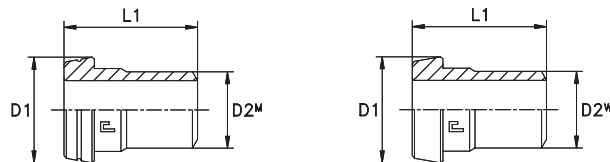

Series ORFS	40.... [bar]	41.... [bar]	Ordering metric Pipe	Ordering Inch Pipe	Ø Tube M	Ø Tube W	D1	D2 ^M	D2 ^W	L1
UNIVERSAL	630	630	402101	402101.W	6	1/4	12,75	6	1/4	25
			402102	402102.W	8-10	5/16-3/8	15,75	10	3/8	26
			402103	402103.W	12	1/2	18,9	12	1/2	26
	420	420	402104	402104.W	14-15-16	5/8	23,45	16	5/8	32
			402105	402105.W	18-20	3/4	27,85	20	3/4	37
			402106	402106.W	22-25	7/8-1	34,2	25	1	42
	280	280	402107	402107.W	28-30-32	1/4	40,55	30	11/4	44
			402108	402108.W	35-38	1/2	48,5	38	11/2	49
	630	630	402109	402109.W	8-10	5/16-3/8	15,75	8	5/16	25
	420	420	402110	-	14-15-16	5/8	23,45	14	-	32
			402111	-	14-15-16	5/8	23,45	15	-	32
			402112	-	18-20	3/4	27,85	18	-	37
			402113	402113.W	22-25	7/8-1	34,2	22	7/8	42
	280	280	402114	-	28-30-32	1/4	40,55	28	-	44
			402115	-	28-30-32	1/4	40,55	32	-	44
			402116	-	35-38	1/2	48,5	35	-	49

Notes: If you wish to order a fitting in stainless steel, please change the first two digit from 40.... to 41.... .

FEMALE GAUGE COUPLING

Thread BSP Parallel

Type: 4022..

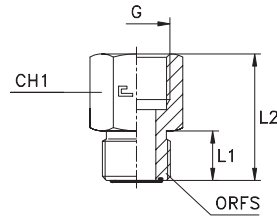

Series ORFS	40.... [bar]	41.... [bar]	Ordering Complete	Ø Tube M	Ø Tube W	G	L1	L2	CH1	ORFS
UNIVERSAL	400	400	402201	6	1/4	1/4	10	27	19	9/16-18
			402202	8-10	5/16-3/8	1/4	11	28	19	11/16-16
			402203	12	1/2	1/4	13	30	22	13/16-16
			402204	6	1/4	1/2	10	37	30	9/16-18
			402205	8-10	5/16-3/8	1/2	11	38	30	11/16-16
			402206	12	1/2	1/2	13	40	30	13/16-16

Notes: If you wish to order a fitting in stainless steel, please change the first two digit from 40.... to 41.... .

FEMALE GAUGE COUPLING

Thread Metric Parallel

Type: 4023..

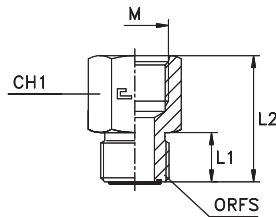

Series ORFS	40.... [bar]	41.... [bar]	Ordering Complete	Ø Tube M	Ø Tube W	M	L1	L2	CH1	ORFS
UNIVERSAL	400	400	402301	6	1/4	14x1,5	10	29	19	9/16-18
			402302	8-10	5/16-3/8	14x1,5	11	30	19	11/16-18
			402303	12	1/2	14x1,5	13	32	22	13/16-16
			402304	14-15-16	5/8	14x1,5	15,5	34,5	27	1-14
			402305	18-20	3/4	14x1,5	17	36	32	13/16-12

Notes: If you wish to order a fitting in stainless steel, please change the first two digit from 40.... to 41.... .

ADJUSTABLE FEMALE GAUGE COUPLING

Thread BSP Parallel

Type: 4024..

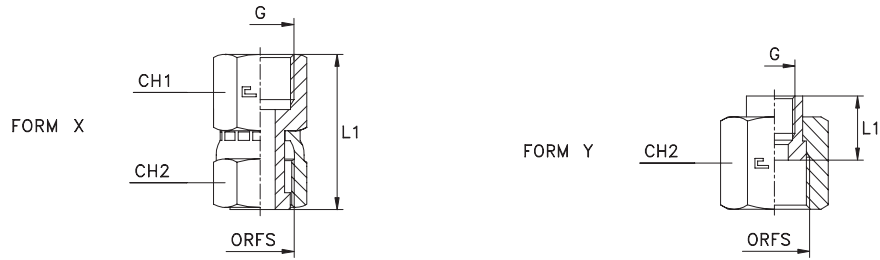

Series ORFS	40.... [bar]	41.... [bar]	Ordering Complete	Ø Tube M	Ø Tube W	Form	G	L1	CH1	CH2	ORFS
UNIVERSAL	630	630	402401	6	1/4	X	1/4	37	19	19	9/16-18
			402402	8-10	5/16-3/8	X	1/4	39	19	22	11/16-16
			402403	12	1/2	X	1/4	42	22	24	13/16-16
	420	420	402404	14-15-16	5/8	Y	1/4	14	-	30	1-14
			402405	18-20	3/4	Y	1/4	14	-	36	13/16-12
			402406	22-25	7/8-1	Y	1/4	15	-	41	17/16-12
	280	280	402407	28-30-32	1 1/4	Y	1/4	15	-	50	1 11/16-12
			402408	35-38	1 1/2	Y	1/4	15	-	60	2-12

Notes: If you wish to order a fitting in stainless steel, please change the first two digit from 40.... to 41....

If you wish to order AISI 316 form Y stainless steel fittings with AISI 304 stainless steel nuts, please change the first two digits from 40.... to 44....

ADJUSTABLE FEMALE GAUGE COUPLING

Thread Metric Parallel

Type: 4025..

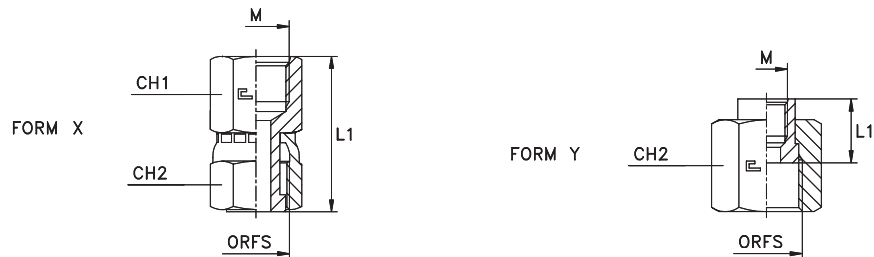

Series ORFS	40.... [bar]	41.... [bar]	Ordering Complete	Ø Tube M	Ø Tube W	Form	M	L1	CH1	CH2	ORFS
UNIVERSAL	630	630	402501	6	1/4	X	10x1	37	19	19	9/16-18
			402502	8-10	5/16-3/8	X	10x1	39	19	22	11/16-16
			402503	12	1/2	X	10x1	42	22	24	13/16-16
	420	420	402504	14-15-16	5/8	Y	10x1	14	-	30	1-14
			402505	18-20	3/4	Y	10x1	14	-	36	13/16-12
			402506	22-25	7/8-1	Y	10x1	15	-	41	17/16-12
	280	280	402507	28-30-32	1 1/4	Y	10x1	15	-	50	1 11/16-12
			402508	35-38	1 1/2	Y	10x1	15	-	60	2-12

Notes: If you wish to order a fitting in stainless steel, please change the first two digit from 40.... to 41....

If you wish to order AISI 316 form Y stainless steel fittings with AISI 304 stainless steel nuts, please change the first two digits from 40.... to 44....

ADAPTER SAE J1453 / DIN 2353

Type: 4026..

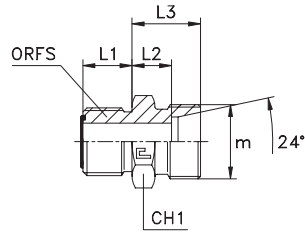

Series ORFS	40.... [bar]	41.... [bar]	Ordering Complete	Ø Tube M	Ø Tube W	Ø Tube 24°	m	L1	L2	L3	CH1	ORFS
UNIVERSAL	315	315	402601	6	1/4	6L	12x1,5	10	10,5	17,5	17	9/16-18
			402602	6	1/4	8L	14x1,5	10	10,5	17,5	17	9/16-18
			402603	8-10	5/16-3/8	10L	16x1,5	11	13	20	19	11/16-16
			402604	12	1/2	12L	18x1,5	13	13,5	20,5	22	13/16-16
			402605	14-15-16	5/8	15L	22x1,5	15,5	16,5	23,5	27	1-14
			402606	18-20	3/4	18L	26x1,5	17	17,5	25	32	13/16-12
	160	160	402607	22-25	7/8-1	22L	30x2	17,5	21	28,5	41	17/16-12
			402608	28-30-32	1 1/4	28L	36x2	17,5	23	30,5	46	11/16-12
			402609	35-38	1 1/2	35L	45x2	17,5	23,5	34	55	2-12
			402610	35-38	1 1/2	42L	52x2	17,5	23	34	55	2-12
	630	630	402611	6	1/4	6S	14x1,5	10	12,5	19,5	17	9/16-18
			402612	6	1/4	8S	16x1,5	10	12,5	20	17	9/16-18
			402613	8-10	5/16-3/8	10S	18x1,5	11	13,5	21	19	11/16-16
			402614	12	1/2	12S	20x1,5	13	14	22	22	13/16-16
	420	420	402615	14-15-16	5/8	14S	22x1,5	15,5	19,5	25,5	27	1-14
	400	400	402616	14-15-16	5/8	16S	24x1,5	15,5	20	25,5	27	1-14
			402617	18-20	3/4	20S	30x2	17	18,5	29	32	13/16-12
			402618	22-25	7/8-1	25S	36x2	17,5	20,5	32,5	41	17/16-12
	280	280	402619	28-30-32	1 1/4	30S	42x2	17,5	23	36,5	46	11/16-12
			402620	35-38	1 1/2	38S	52x2	17,5	24	40	55	2-12

Notes: If you wish to order a fitting in stainless steel, please change the first two digit from 40.... to 41....

ADAPTER SAE J1453 / DIN 2353 WITH SWIVEL NUT

Type: 4027..

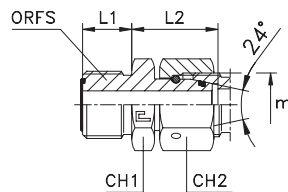

Series ORFS	40.... [bar]	41.... [bar]	Ordering Complete	Ø Tube M	Ø Tube W	Ø Tube 24°	m	L1	L2	CH1	CH2	ORFS
UNIVERSAL	315	315	402701	6	1/4	6L	12x1,5	10	24,5	17	14	9/16-18
			402702	6	1/4	8L	14x1,5	10	24,5	17	17	9/16-18
			402703	8-10	5/16-3/8	10L	16x1,5	11	26,5	19	19	11/16-16
			402704	12	1/2	12L	18x1,5	13	27	22	22	13/16-16
			402705	14-15-16	5/8	15L	22x1,5	15,5	31	27	27	1-14
			402706	18-20	3/4	18L	26x1,5	17	33,5	32	32	13/16-12
	160	160	402707	22-25	7/8-1	22L	30x2	17,5	36	41	36	17/16-12
			402708	28-30-32	1 1/4	28L	36x2	17,5	39	46	41	11/16-12
			402709	35-38	1 1/2	35L	45x2	17,5	45	55	50	2-12
			402710	35-38	1 1/2	42L	52x2	17,5	45	55	60	2-12
	630	630	402711	6	1/4	6S	14x1,5	10	24,5	17	17	9/16-18
			402712	6	1/4	8S	16x1,5	10	25	17	19	9/16-18
			402713	8-10	5/16-3/8	10S	18x1,5	11	27	19	22	11/16-16
			402714	12	1/2	12S	20x1,5	13	27,5	22	24	13/16-16
	420	420	402715	14-15-16	5/8	14S	22x1,5	15,5	32,5	27	27	1-14
	400	400	402716	14-15-16	5/8	16S	24x1,5	15,5	35	27	30	1-14
			402717	18-20	3/4	20S	30x2	17	39	32	36	13/16-12
			402718	22-25	7/8-1	25S	36x2	17,5	43	41	46	17/16-12
	280	280	402719	28-30-32	1 1/4	30S	42x2	17,5	47,5	46	50	11/16-12
			402720	35-38	1 1/2	38S	52x2	17,5	51	55	60	2-12

Notes: If you wish to order a fitting in stainless steel, please change the first two digit from 40.... to 41....

ADAPTER SAE J1453 / SAE J514

Type: 4028...3

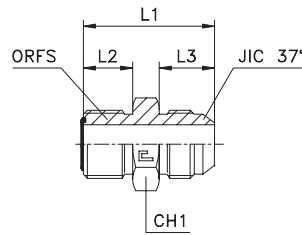

Series ORFS	40.... [bar]	41.... [bar]	Ordering Complete	Ø Tube M	Ø Tube W	Ø Tube 37°-M	Ø Tube 37°-W	L1	L2	L3	CH1	ORFS	JIC 37°
UNIVERSAL	450	450	402801.3	6	1/4	6	1/4	31,5	10	13,9	17	9/16-18	7/16-20
			402802.3	8-10	5/16-3/8	10	3/8	34	11	14	19	11/16-16	9/16-18
	350	350	402803.3	12	1/2	12	1/2	39	13	16,7	22	13/16-16	3/4-16
			402804.3	14-15-16	5/8	14-15-16	5/8	46,5	15,5	19,3	27	1-14	7/8-14
			402805.3	18-20	3/4	18-20	3/4	52	17	21,9	32	13/16-12	11/16-12
	290	290	402806.3	22-25	7/8-1	25	1	55	17,5	23,1	41	17/16-12	15/16-12
	240	240	402807.3	28-30-32	1 1/4	30-32	1 1/4	58,5	17,5	24,3	46	111/16-12	15/8-12
			402808.3	35-38	1 1/2	38	1 1/2	63	17,5	27,5	55	2-12	17/8-12
	450	450	402809.3	8-10	5/16-3/8	8	5/16	34	11	14	19	11/16-16	1/2-20

Notes: If you wish to order a fitting in stainless steel, please change the first two digit from 40.... to 41.... .

ADAPTER SAE J1453 / SAE J514 WITH SWIVEL NUT

Type: 4029..

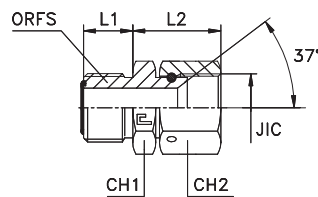

Series ORFS	40.... [bar]	41.... [bar]	Ordering Complete	Ø Tube M	Ø Tube W	Ø Tube 37°- M	Ø Tube 37°- W	L1	L2	CH1	CH2	ORFS	JIC 37°
UNIVERSAL	450	450	402901	6	1/4	6	1/4	10	25	17	14	9/16-18	7/16-20
			402902	8-10	5/16-3/8	10	3/8	11	29	19	19	11/16-16	9/16-18
	350	350	402903	12	1/2	12	1/2	13	31,5	22	22	13/16-16	3/4-16
			402904	14-15-16	5/8	14-15-16	5/8	15,5	37,5	27	27	1-14	7/8-14
			402905	18-20	3/4	18-20	3/4	17	39	32	32	13/16-12	11/16-12
	290	290	402906	22-25	7/8-1	25	1	17,5	44,5	41	41	17/16-12	15/16-12
	240	240	402907	28-30-32	1 1/4	30-32	1 1/4	17,5	45,5	46	50	111/16-12	15/8-12
			402908	35-38	1 1/2	38	1 1/2	17,5	55,5	55	60	2-12	17/8-12
	450	450	402909	8-10	5/16-3/8	8	5/16	11	28	19	17	11/16-16	1/2-20

Notes: If you wish to order a fitting in stainless steel, please change the first two digit from 40.... to 41.... .

ADAPTER SAE J1453 WITH SWIVEL NUT / SAE J514

Type: 4030...3

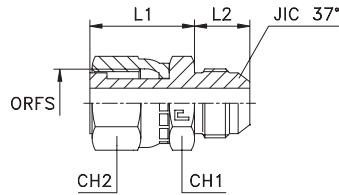

Series ORFS	40.... [bar]	41.... [bar]	Ordering Complete	Ø Tube M	Ø Tube W	Ø Tube 37°-M	Ø Tube 37°-W	L1	L2	CH1	CH2	ORFS	JIC 37°
UNIVERSAL	450	450	403001.3	6	1/4	6	1/4	23,5	13,9	17	19	9/16-18	7/16-20
	350	350	403002.3	8-10	5/16-3/8	10	3/8	26,9	14	19	22	11/16-16	9/16-18
			403003.3	12	1/2	12	1/2	30,3	16,7	22	24	13/16-16	3/4-16
			403004.3	14-15-16	5/8	14-15-16	5/8	36,7	19,3	27	30	1-14	7/8-14
			403005.3	18-20	3/4	18-20	3/4	40,6	21,9	32	36	13/16-12	11/16-12
	290	290	403006.3	22-25	7/8-1	25	1	42,9	23,1	41	46	17/16-12	15/16-12
	240	240	403007.3	28-30-32	1 1/4	30-32	1 1/4	45,2	24,3	46	50	111/16-12	15/8-12
			403008.3	35-38	1 1/2	38	1 1/2	46,5	27,5	55	60	2-12	17/8-12
	450	450	403009.3	8-10	5/16-3/8	8	5/16	27	14	19	22	11/16-16	1/2-20

Notes: If you wish to order a fitting in stainless steel, please change the first two digit from 40.... to 41.... .

ADAPTER SAE J1453 / BS 5200

Type: 4031..

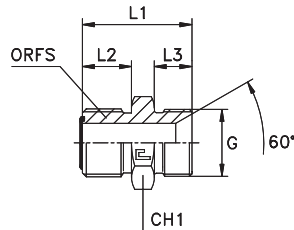

Series ORFS	40.... [bar]	41.... [bar]	Ordering Complete	Ø Tube M	Ø Tube W	G	L1	L2	L3	CH1	ORFS	
UNIVERSAL	400	400	403101	6	1/4	1/8	25,5	10	8	17	9/16-18	
			403102	8-10	5/16-3/8	1/4	31	11	11	19	11/16-16	
			403103	12	1/2	3/8	34,5	13	12	22	13/16-16	
	350	350	403104	14-15-16	5/8	1/2	41	15,5	14	27	1-14	
	315	315	403105	18-20	3/4	3/4	46	17	16	32	13/16-12	
	250	250	403106	22-25	7/8-1	1	51	17,5	19	41	17/16-12	
	200	200	403107	28-30-32	1 1/4	1 1/4	54	17,5	20	46	111/16-12	
	160	160	403108	35-38	1 1/2	1 1/2	58,5	17,5	23	55	2-12	
	400	400	403109	6	1/4	1/4	28,5	10	11	17	9/16-18	
			403110	6	1/4	3/8	29,5	10	12	17	9/16-18	
			403111	8-10	5/16-3/8	3/8	32	11	12	19	11/16-16	
		350	350	403112	8-10	5/16-3/8	1/2	34,5	11	14	22	11/16-16
		400	400	403113	12	1/2	1/4	33,5	13	11	22	13/16-16
		350	350	403114	12	1/2	1/2	36,5	13	14	22	13/16-16
		315	315	403115	12	1/2	3/4	40,5	13	16	27	13/16-16
		400	400	403116	14-15-16	5/8	3/8	39	15,5	12	27	1-14
		350	350	403117	14-15-16	5/8	5/8	43	15,5	16	27	1-14
		315	315	403118	14-15-16	5/8	3/4	43	15,5	16	27	1-14
		350	350	403119	18-20	3/4	1/2	44	17	14	32	13/16-12
		250	250	403120	18-20	3/4	1	49	17	19	36	13/16-12
		315	315	403121	22-25	7/8-1	3/4	48	17,5	16	41	17/16-12
		200	200	403122	22-25	7/8-1	1 1/4	54	17,5	20	46	17/16-12

Notes: If you wish to order a fitting in stainless steel, please change the first two digit from 40.... to 41.... .

ADAPTER SAE J1453 WITH SWIVEL NUT / BS 5200

Type: 4032..

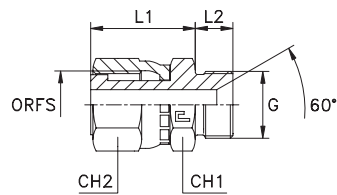

Series ORFS	40.... [bar]	41.... [bar]	Ordering Complete	Ø Tube M	Ø Tube W	G	L1	L2	CH1	CH2	ORFS
UNIVERSAL	400	400	403201	6	1/4	1/8	23,5	8	17	19	9/16-18
			403202	8-10	5/16-3/8	1/4	27	11	19	22	11/16-16
			403203	12	1/2	3/8	30,5	12	22	24	13/16-16
	350	350	403204	14-15-16	5/8	1/2	36,5	14	27	30	1-14
	315	315	403205	18-20	3/4	3/4	40,5	16	32	36	13/16-12
	250	250	403206	22-25	7/8-1	1	43	19	41	46	17/16-12
	200	200	403207	28-30-32	1 1/4	1 1/4	45	20	46	50	1 11/16-12
	160	160	403208	35-38	1 1/2	1 1/2	46,5	23	55	60	2-12
	400	400	403209	6	1/4	1/4	23,5	11	17	19	9/16-18
			403210	6	1/4	3/8	23,5	12	17	19	9/16-18
			403211	8-10	5/16-3/8	3/8	27	12	19	22	11/16-16
	350	350	403212	8-10	5/16-3/8	1/2	27,5	14	22	22	11/16-16
	400	400	403213	12	1/2	1/4	30,5	11	22	24	13/16-16
	350	350	403214	12	1/2	1/2	30,5	14	22	24	13/16-16
	315	315	403215	12	1/2	3/4	32,5	16	27	24	13/16-16
	400	400	403216	14-15-16	5/8	3/8	36,5	12	27	30	1-14
	350	350	403217	14-15-16	5/8	5/8	36,5	16	27	30	1-14
	315	315	403218	14-15-16	5/8	3/4	36,5	16	27	30	1-14
	350	350	403219	18-20	3/4	1/2	40,5	14	32	36	13/16-12
	250	250	403220	18-20	3/4	1	40,5	19	36	36	13/16-12
	315	315	403221	22-25	7/8-1	3/4	43	16	41	46	17/16-12
	200	200	403222	22-25	7/8-1	1 1/4	45	20	46	46	17/16-12

Notes: If you wish to order a fitting in stainless steel, please change the first two digit from 40.... to 41.... .

MALE STUD CRIMPED NUT COUPLING WITH CRIMPED NUT AND ELASTOMERIC SEAL

Thread BSP Parallel

Type: 4033..

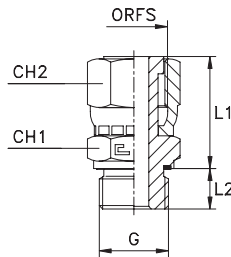

Series ORFS	40.... [bar]	41.... [bar]	Ordering Complete	Ø Tube M	Ø Tube W	G	L1	L2	CH1	CH2	ORFS
UNIVERSAL	630	630	403301	6	1/4	1/8	26,5	8	17	19	9/16-18
			403302	8-10	5/16-3/8	1/4	28,5	12	19	22	11/16-16
			403303	12	1/2	3/8	35,5	12	22	24	13/16-16
	420	420	403304	14-15-16	5/8	1/2	38	14	27	30	1-14
			403305	18-20	3/4	3/4	41,5	16	32	36	13/16-12
			403306	22-25	7/8-1	1	49	18	41	46	17/16-12
	280	280	403307	28-30-32	1 1/4	1 1/4	49	20	50	50	111/16-12
			403308	35-38	1 1/2	1 1/2	49	22	55	60	2-12
	630	630	403309	6	1/4	1/4	26,5	12	19	19	9/16-18
			403310	8-10	5/16-3/8	3/8	32,5	12	22	22	11/16-16
			403311	12	1/2	1/2	34	14	27	24	13/16-16
	420	420	403312	18-20	3/4	1 1/4	48	20	50	36	13/16-12

Notes: If you wish to order a fitting in stainless steel, please change the first two digit from 40.... to 41.... .
Articles available on scheduled orders only.

MALE NUT COUPLING WITH CRIMPED NUT AND ELASTOMERIC SEAL

Thread Metric Parallel

Type: 4034..

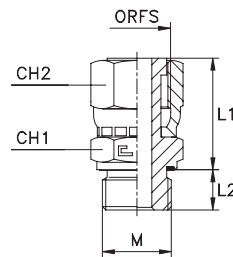

Series ORFS	40.... [bar]	41.... [bar]	Ordering Complete	Ø Tube M	Ø Tube W	G	L1	L2	CH1	CH2	ORFS
UNIVERSAL	630	630	403401	6	1/4	12x1,5	26,5	12	17	19	9/16-18
			403402	8-10	5/16-3/8	14x1,5	28,5	12	19	22	11/16-16
			403403	12	1/2	18x1,5	35,5	12	24	24	13/16-16
	420	420	403404	14-15-16	5/8	22x1,5	38	14	27	30	1-14
			403405	18-20	3/4	27x2	41,5	16	32	36	13/16-12
			403406	22-25	7/8-1	33x2	49	18	41	46	17/16-12
	280	280	403407	28-30-32	1 1/4	42x2	49	20	50	50	111/16-12
			403408	35-38	1 1/2	48x2	49	22	55	60	2-12
	350	350	403409	6	1/4	10x1	26,5	8	17	19	9/16-18
	630	630	403410	8-10	5/16-3/8	16x1,5	28,5	12	22	22	11/16-16
			403411	12	1/2	16x1,5	31,5	12	22	24	13/16-16
	420	420	403412	14-15-16	5/8	18x1,5	38	12	27	30	1-14
			403413	18-20	3/4	22x1,5	41,5	14	32	36	13/16-12
			403414	22-25	7/8-1	27x2	49	16	41	46	17/16-12

Notes: If you wish to order a fitting in stainless steel, please change the first two digit from 40.... to 41.... .

MALE STUD COUPLING WITH CRIMPED NUT AND O-RING

Thread UNF/UN-2A

Type: 4035..

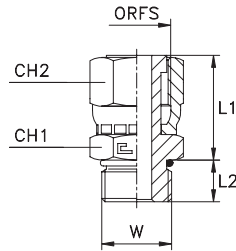

Series ORFS	40.... [bar]	41.... [bar]	Ordering Complete	Ø Tube M	Ø Tube W	W	L1	L2	CH1	CH2	ORFS
UNIVERSAL	630	630	403501	6	1/4	7/16-20	26,5	11	17	19	9/16-18
			403502	8-10	5/16-3/8	9/16-18	28,5	12	19	22	11/16-16
			403503	12	1/2	3/4-16	35,5	14	22	24	13/16-16
	420	420	403504	14-15-16	5/8	7/8-14	38	16	27	30	1-14
			403505	18-20	3/4	1 1/16-12	41,5	18,5	32	36	13/16-12
			403506	22-25	7/8-1	15/16-12	49	18,5	41	46	17/16-12
	280	280	403507	28-30-32	1 1/4	15/8-12	49	18,5	46	50	1 11/16-12
			403508	35-38	1 1/2	17/8-12	49	18,5	55	60	2-12
	630	630	403509	8-10	5/16-3/8	7/16-20	28,5	11	19	22	11/16-16
			403510	8-10	5/16-3/8	3/4-16	32,5	14	22	22	11/16-16
			403511	12	1/2	7/8-14	34	16	27	24	13/16-16
	420	420	403512	14-15-16	5/8	3/4-16	38	14	27	30	1-14
			403513	14-15-16	5/8	1 1/16-12	39	18,5	32	30	1-14
			403514	18-20	3/4	7/8-14	41,5	16	32	36	13/16-12
			403515	18-20	3/4	15/16-12	48	18,5	41	36	13/16-12

Notes: If you wish to order a fitting in stainless steel, please change the first two digit from 40.... to 41.... .

MALE STUD COUPLING WITH O-RING CRIMPED NUT AND WASHER

Thread BSP Parallel

Type: 4036..

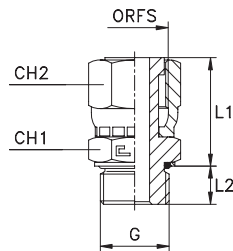

Series ORFS	40.... [bar]	41.... [bar]	Ordering Complete	Ø Tube M	Ø Tube W	G	L1	L2	CH1	CH2	ORFS
UNIVERSAL	350	350	403601	6	1/4	1/8	27,8	6,7	17	19	9/16-18
	400	400	403602	8-10	5/16-3/8	1/4	30,3	10,2	19	22	11/16-16
	350	350	403603	12	1/2	3/8	37,3	10,2	22	24	13/16-16
	315	315	403604	14-15-16	5/8	1/2	39,8	12,2	27	30	1-14
			403605	18-20	3/4	3/4	43,3	12,7	32	36	13/16-12
	280	280	403606	22-25	7/8-1	1	51,6	15,4	41	46	17/16-12
			403607	28-30-32	1 1/4	1 1/4	51,5	16	50	50	1 11/16-12
	250	250	403608	35-38	1 1/2	1 1/2	51,5	16	55	60	2-12
	400	400	403609	6	1/4	1/4	28,3	10,2	19	19	9/16-18
	350	350	403610	8-10	5/16-3/8	3/8	34,3	10,2	22	22	11/16-16
	315	315	403611	12	1/2	1/2	35,8	12,2	27	24	13/16-16
	200	200	403612	18-20	3/4	1 1/4	50,5	16	50	36	13/16-12

Notes: If you wish to order a fitting in stainless steel, please change the first two digit from 40.... to 41.... .

MALE STUD COUPLING WITH CRIMPED NUT O-RING AND WASHER

Thread Metric Parallel

Type: 4037..

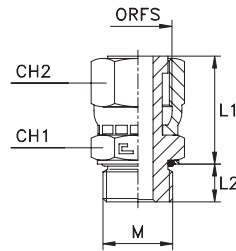

Series ORFS	40.... [bar]	41.... [bar]	Ordering Complete	Ø Tube M	Ø Tube W	M	L1	L2	CH1	CH2	ORFS
UNIVERSAL	400	400	403701	6	1/4	12x1,5	27,9	9,6	17	19	9/16-18
			403702	8-10	5/16-3/8	14x1,5	28,9	9,6	19	22	11/16-16
			403703	12	1/2	18x1,5	36,9	12,6	24	24	13/16-16
	315	315	403704	14-15-16	5/8	22x1,5	39,4	13,6	27	30	1-14
			403705	18-20	3/4	27x2	43,5	16,5	32	36	13/16-12
	280	280	403706	22-25	7/8-1	33x2	51	16,5	41	46	17/16-12
			403707	28-30-32	1 1/4	42x2	51	17	50	50	111/16-12
	250	250	403708	35-38	1 1/2	48x2	51	19,5	55	60	2-12
	400	400	403709	6	1/4	10x1	27,5	7,5	17	19	9/16-18
			403710	8-10	5/16-3/8	16x1,5	29,9	11,1	22	22	11/16-16
			403711	12	1/2	16x1,5	32,9	11,1	22	24	13/16-16
			403712	14-15-16	5/8	18x1,5	39,4	12,6	27	30	1-14
	315	315	403713	18-20	3/4	22x1,5	42,9	13,6	32	36	13/16-12
			403714	22-25	7/8-1	27x2	51	16,5	41	46	17/16-12

Notes: If you wish to order a fitting in stainless steel, please change the first two digit from 40.... to 41.... .

STRAIGHT WITH DOUBLE CRIMPED NUT COUPLING

Type: 4038..

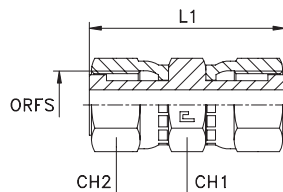

Series ORFS	40.... [bar]	41.... [bar]	Ordering Complete	Ø Tube M	Ø Tube W	L1	CH1	CH2	ORFS
UNIVERSAL	630	630	403801	6	1/4	39,5	17	19	9/16-18
			403802	8-10	5/16-3/8	45	19	22	11/16-16
			403803	12	1/2	51,5	22	24	13/16-16
	420	420	403804	14-15-16	5/8	61,5	27	30	1-14
			403805	18-20	3/4	68	32	36	13/16-12
			403806	22-25	7/8-1	71,5	41	46	17/16-12
	280	280	403807	28-30-32	1 1/4	73,5	46	50	111/16-12
			403808	35-38	1 1/2	75	55	60	2-12

Notes: If you wish to order a fitting in stainless steel, please change the first two digit from 40.... to 41.... .

MALE STUD ELBOW

Thread NPTF

Type: **4039..**

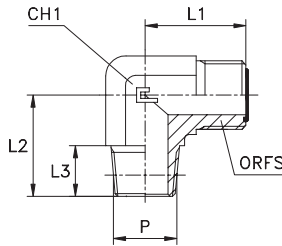

MALE STUD ELBOW 45°

Thread NPTF

Type: **4040..**

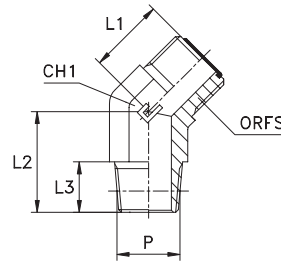

Series ORFS	40.... [bar]	41.... [bar]	Ordering Complete	Ø Tube M	Ø Tube W	P	L1	L2	L3	CH1	ORFS
UNIVERSAL	420	420	403901	6	1/4	1/8	21,5	20	10	14	9/16-18
	630	630	403902	8-10	5/16-3/8	1/4	25	31	14,5	19	11/16-16
			403903	12	1/2	3/8	28	31	14,5	19	13/16-16
	420	420	403904	14-15-16	5/8	1/2	33,5	37,5	19	27	1-14
			403905	18-20	3/4	3/4	37,5	40	19	30	13/16-12
			403906	22-25	7/8-1	1	41,5	50	24	36	17/16-12
	280	280	403907	28-30-32	1 1/4	1 1/4	44,5	60	25	41	11/16-12
			403908	35-38	1 1/2	1 1/2	49	67	26	48	2-12
	630	630	403909	6	1/4	1/4	21,5	28	14,5	14	9/16-18
			403910	6	1/4	3/8	23,5	31	14,5	19	9/16-18
			403911	8-10	5/16-3/8	3/8	25	31	14,5	19	11/16-16
			403912	8-10	5/16-3/8	1/2	28	37,5	19	22	11/16-16
			403913	12	1/2	1/4	28	31	14,5	19	13/16-16
			403914	12	1/2	1/2	30	37,5	19	22	13/16-16
	420	420	403915	12	1/2	3/4	31,5	40	19	27	13/16-16
			403916	14-15-16	5/8	3/8	33,5	33	14,5	27	1-14
			403917	14-15-16	5/8	3/4	33,5	40	19	27	1-14
			403918	18-20	3/4	1/2	37,5	40	19	30	13/16-12
			403919	18-20	3/4	1	38	50	24	33	13/16-12
			403920	22-25	7/8-1	3/4	41,5	45,5	19	36	17/16-12
	280	280	403921	28-30-32	1 1/4	1	44,5	51	24	41	11/16-12
			403922	35-38	1 1/2	1 1/4	49	66	25	48	2-12

Notes: If you wish to order a fitting in stainless steel, please change the first two digit from **40....** to **41....** .

Series ORFS	40.... [bar]	41.... [bar]	Ordering Complete	Ø Tube M	Ø Tube W	P	L1	L2	L3	CH1	ORFS
UNIVERSAL	420	420	404001	6	1/4	1/8	16	16,5	10	14	9/16-18
	630	630	404002	8-10	5/16-3/8	1/4	19	24	14,5	19	11/16-16
			404003	12	1/2	3/8	20,5	24	14,5	19	13/16-16
	420	420	404004	14-15-16	5/8	1/2	23,5	30,5	19	27	1-14
			404005	18-20	3/4	3/4	26	30,5	19	30	13/16-12
			404006	22-25	7/8-1	1	30	38	24	36	17/16-12
	280	280	404007	28-30-32	1 1/4	1 1/4	32	42	25	41	11/16-12
			404008	35-38	1 1/2	1 1/2	37	45	26	48	2-12
	630	630	404009	6	1/4	1/4	16	22	14,5	14	9/16-18
			404010	6	1/4	3/8	17,5	24	14,5	19	9/16-18
			404011	8-10	5/16-3/8	3/8	19	24	14,5	19	11/16-16
			404012	8-10	5/16-3/8	1/2	20	29,5	19	22	11/16-16
			404013	12	1/2	1/4	20,5	24	14,5	19	13/16-16
			404014	12	1/2	1/2	21	29,5	19	22	13/16-16
	420	420	404015	12	1/2	3/4	21,5	30,5	19	27	13/16-16
			404016	14-15-16	5/8	3/8	23,5	27	14,5	27	1-14
			404017	14-15-16	5/8	3/4	23,5	30,5	19	27	1-14
			404018	18-20	3/4	1/2	26	30,5	19	30	13/16-12
			404019	18-20	3/4	1	29,5	38	24	33	13/16-12
			404020	22-25	7/8-1	3/4	30	33	19	36	17/16-12
	280	280	404021	28-30-32	1 1/4	1	32	41	24	41	11/16-12
			404022	35-38	1 1/2	1 1/4	37	44	25	48	2-12

Notes: If you wish to order a fitting in stainless steel, please change the first two digit from **40....** to **41....** .

MALE WELDABLE ELBOW

Type: 4041..

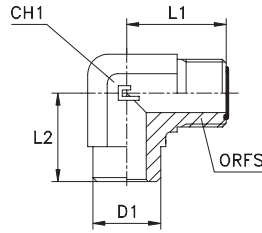

Series ORFS	40.... [bar]	41.... [bar]	Ordering Complete	Ø Tube M	Ø Tube W	D1	L1	L2	CH1	ORFS
UNIVERSAL	630	630	404101	6	1/4	6	21,5	20	14	9/16-18
			404102	8-10	5/16-3/8	10	25	25	19	11/16-16
			404103	12	1/2	12	28	25	19	13/16-16
	420	420	404104	14-15-16	5/8	16	33,5	33,5	27	1-14
			404105	18-20	3/4	20	37,5	37,5	30	13/16-12
			404106	22-25	7/8-1	25	41,5	42	36	17/16-12
	280	280	404107	28-30-32	1 1/4	30	44,5	45	41	1 11/16-12
			404108	35-38	1 1/2	38	49	49	48	2-12
	630	630	404109	8-10	5/16-3/8	8	25	25	19	11/16-16
			404110	14-15-16	5/8	14	33,5	33,5	27	1-14
	420	420	404111	14-15-16	5/8	15	33,5	33,5	27	1-14
			404112	18-20	3/4	18	37,5	37,5	30	13/16-12
			404113	22-25	7/8-1	22	41,5	42	36	17/16-12
	280	280	404114	28-30-32	1 1/4	28	44,5	45	41	1 11/16-12
			404115	28-30-32	1 1/4	32	44,5	45	41	1 11/16-12
			404116	35-38	1 1/2	35	49	49	48	2-12

Notes: If you wish to order a fitting in stainless steel, please change the first two digit from 40.... to 41....

FEMALE WELDABLE ELBOW

Type: 4042..

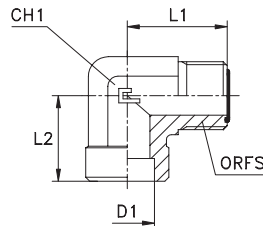

Series ORFS	40.... [bar]	41.... [bar]	Ordering Complete	Ø Tube M	Ø Tube W	D1	L1	L2	CH1	ORFS
UNIVERSAL	630	630	404201	6	1/4	6	21,5	20	14	9/16-18
			404202	8-10	5/16-3/8	10	25	23	19	11/16-16
			404203	12	1/2	12	28	25	19	13/16-16
	420	420	404204	14-15-16	5/8	16	33,5	30	27	1-14
			404205	18-20	3/4	20	37,5	32	30	13/16-12
			404206	22-25	7/8-1	25	41,5	36	36	17/16-12
	280	280	404207	28-30-32	1 1/4	30	44,5	42	41	1 11/16-12
			404208	35-38	1 1/2	38	49	44	48	2-12
	630	630	404209	8-10	5/16-3/8	8	25	23	19	11/16-16
			404210	14-15-16	5/8	14	33,5	30	27	1-14
	420	420	404211	14-15-16	5/8	15	33,5	30	27	1-14
			404212	18-20	3/4	18	37,5	32	30	13/16-12
			404213	22-25	7/8-1	22	41,5	36	36	17/16-12
	280	280	404214	28-30-32	1 1/4	28	44,5	42	41	1 11/16-12
			404215	28-30-32	1 1/4	32	44,5	42	41	1 11/16-12
			404216	35-38	1 1/2	35	49	44	48	2-12

Notes: If you wish to order a fitting in stainless steel, please change the first two digit from 40.... to 41....

EQUAL ELBOW

Type: 4043..

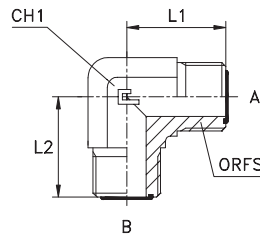

Series ORFS	40.... [bar]	41.... [bar]	Ordering Complete	Ø Tube A ^M	Ø Tube B ^M	Ø Tube A ^W	Ø Tube B ^W	L2	L3	CH1	ORFS A	ORFS B
UNIVERSAL	630	630	404301	6	6	1/4	1/4	21,5	21,5	14	9/16-18	9/16-18
			404302	8-10	8-10	5/16-3/8	5/16-3/8	25	25	19	11/16-16	11/16-16
			404303	12	12	1/2	1/2	28	28	19	13/16-16	13/16-16
	420	420	404304	14-15-16	14-15-16	5/8	5/8	33,5	33,5	27	1-14	1-14
			404305	18-20	18-20	3/4	3/4	37,5	37,5	30	13/16-12	13/16-12
			404306	22-25	22-25	7/8-1	7/8-1	41,5	41,5	36	17/16-12	17/16-12
	280	280	404307	28-30-32	28-30-32	1 1/4	1 1/4	44,5	44,5	41	1 11/16-12	1 11/16-12
			404308	35-38	35-38	1 1/2	1 1/2	49	49	48	2-12	2-12
	630	630	404309	8-10	6	5/16-3/8	1/4	25	23,5	19	11/16-16	9/16-18
			404310	12	8-10	1/2	3/8-5/16	28	25	19	13/16-16	11/16-16
	420	420	404311	14-15-16	12	5/8	1/2	33,5	31,5	27	1-14	13/16-16
			404312	18-20	8-10	3/4	5/16-3/8	37,5	32,5	30	13/16-12	11/16-16
			404313	18-20	12	3/4	1/2	37,5	34,5	30	13/16-12	13/16-16
			404314	18-20	14-15-16	3/4	5/8	37,5	36,5	30	13/16-12	1-14
			404315	22-25	18-20	7/8-1	3/4	41,5	41	36	17/16-12	13/16-12
	280	280	404316	28-30-32	22-25	1 1/4	7/8-1	44,5	44,5	41	1 11/16-12	17/16-12

Notes: If you wish to order a fitting in stainless steel, please change the first two digit from 40.... to 41.... .

EQUAL 45° ELBOW

Type: 4044..

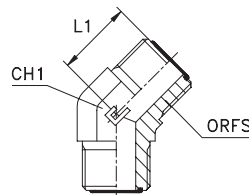

Series ORFS	40.... [bar]	41.... [bar]	Ordering Complete	Ø Tube M	Ø Tube W	L1	CH1	ORFS
UNIVERSAL	630	630	404401	6	1/4	16	14	9/16-18
			404402	8-10	5/16-3/8	19	19	11/16-16
			404403	12	1/2	20,5	19	13/16-16
	420	420	404404	14-15-16	5/8	23,5	27	1-14
			404405	18-20	3/4	26	30	13/16-12
			404406	22-25	7/8-1	30	36	17/16-12
	280	280	404407	28-30-32	1 1/4	32	41	1 11/16-12
			404408	35-38	1 1/2	37	48	2-12

Notes: If you wish to order a fitting in stainless steel, please change the first two digit from 40.... to 41.... .

45° BULKHEAD ELBOW

Type: 4045..

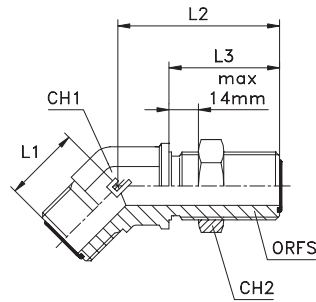

Series ORFS	40.... [bar]	41.... [bar]	Ordering Complete	Ø Tube M	Ø Tube W	L1	L2	L3	CH1	CH2	ORFS
UNIVERSAL	630	630	404501	6	1/4	16	44	31,5	14	22	9/16-18
			404502	8-10	5/16-3/8	19	48,5	34	19	27	11/16-16
			404503	12	1/2	20,5	51	36,5	19	30	13/16-16
	420	420	404504	14-15-16	5/8	23,5	56,5	40,5	27	36	1-14
			404505	18-20	3/4	26	60,5	41,5	30	41	13/16-12
			404506	22-25	7/8-1	30	65	42	36	46	17/16-12
	280	280	404507	28-30-32	1 1/4	32	67	42	41	50	111/16-12
			404508	35-38	1 1/2	37	67	42	48	60	2-12

Notes: If you wish to order a fitting in stainless steel, please change the first two digit from 40.... to 41....

BULKHEAD ELBOW

Type: 4046..

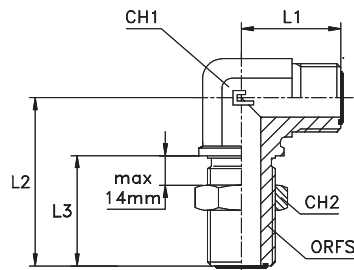

Series ORFS	40.... [bar]	41.... [bar]	Ordering Complete	Ø Tube M	Ø Tube W	L1	L2	L3	CH1	CH2	ORFS
UNIVERSAL	630	630	404601	6	1/4	21,5	47	31,5	14	22	9/16-18
			404602	8-10	5/16-3/8	25	52	34	19	27	11/16-16
			404603	12	1/2	28	55,5	36,5	19	30	13/16-16
	420	420	404604	14-15-16	5/8	33,5	63	40,5	27	36	1-14
			404605	18-20	3/4	37,5	67	41,5	30	41	13/16-12
			404606	22-25	7/8-1	41,5	71	42	36	46	17/16-12
	280	280	404607	28-30-32	1 1/4	44,5	75,5	42	41	50	111/16-12
			404608	35-38	1 1/2	49	79,5	42	48	60	2-12

Notes: If you wish to order a fitting in stainless steel, please change the first two digit from 40.... to 41....

EQUAL TEE

Type: 4049..

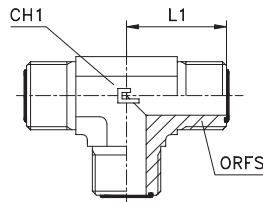

Series ORFS	40.... [bar]	41.... [bar]	Ordering Complete	Ø Tube M	Ø Tube W	L1	CH1	ORFS
UNIVERSAL	630	630	404901	6	1/4	21,5	14	9/16-18
			404902	8-10	5/16-3/8	25	19	11/16-16
			404903	12	1/2	28	19	13/16-16
	420	420	404904	14-15-16	5/8	33,5	27	1-14
			404905	18-20	3/4	37,5	30	13/16-12
			404906	22-25	7/8-1	41,5	36	17/16-12
	280	280	404907	28-30-32	1 1/4	44,5	41	1 11/16-12
			404908	35-38	1 1/2	49	48	2-12

Notes: If you wish to order a fitting in stainless steel, please change the first two digit from 40.... to 41.... .

EQUAL CROSS

Type: 4050..

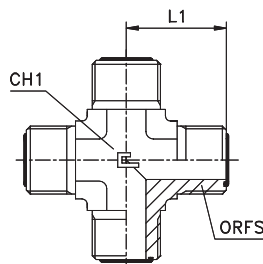

Series ORFS	40.... [bar]	41.... [bar]	Ordering Complete	Ø Tube M	Ø Tube W	L1	CH1	ORFS
UNIVERSAL	630	630	405001	6	1/4	21,5	14	9/16-18
			405002	8-10	5/16-3/8	25	19	11/16-16
			405003	12	1/2	28	19	13/16-16
	420	420	405004	14-15-16	5/8	33,5	27	1-14
			405005	18-20	3/4	37,5	30	13/16-12
			405006	22-25	7/8-1	41,5	36	17/16-12
	280	280	405007	28-30-32	1 1/4	44,5	41	1 11/16-12
			405008	35-38	1 1/2	49	48	2-12

Notes: If you wish to order a fitting in stainless steel, please change the first two digit from 40.... to 41.... .

ADJUSTABLE MALE STUD ELBOW WITH O-RING AND WASHER

Thread BSP Parallel - Thread Metric Parallel

Type: 4051..

Type: 4052..

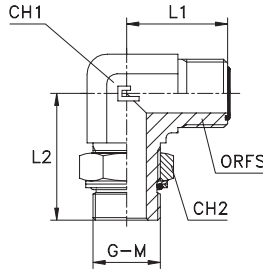

Series ORFS	40.... [bar]	41.... [bar]	Ordering Complete	Ø Tube M	Ø Tube W	G	L1	L2	CH1	CH2	ORFS
UNIVERSAL	350	350	405101	6	1/4	1/8	21,5	30	14	14	9/16-18
	315	315	405102	8-10	5/16-3/8	1/4	25	37	19	19	11/16-16
	250	250	405103	12	1/2	3/8	28	38	19	22	13/16-16
			405104	14-15-16	5/8	1/2	33,5	48	27	27	1-14
			405105	18-20	3/4	3/4	37,5	51,5	30	36	13/16-12
	200	200	405106	22-25	7/8-1	1	41,5	58,5	36	41	17/16-12
			405107	28-30-32	1 1/4	1 1/4	44,5	60,5	41	50	1 11/16-12
	160	160	405108	35-38	1 1/2	1 1/2	49	64	48	55	2-12
	315	315	405109	6	1/4	1/4	21,5	35	14	19	9/16-18
	250	250	405110	6	1/4	3/8	23,5	38	19	22	9/16-18
			405111	8-10	5/16-3/8	3/8	25	38	19	22	11/16-16
			405112	8-10	5/16-3/8	1/2	28	48	22	27	11/16-16
	315	315	405113	12	1/2	1/4	28	37	19	19	13/16-16
	250	250	405114	12	1/2	1/2	30	48	22	27	13/16-16
			405115	12	1/2	3/4	31,5	51,5	27	36	13/16-16
	315	315	405116	14-15-16	5/8	1/4	33,5	42,5	27	19	1-14
	250	250	405117	14-15-16	5/8	3/8	33,5	42,5	27	22	1-14
			405118	14-15-16	5/8	3/4	33,5	51,5	27	36	1-14
	200	200	405119	14-15-16	5/8	1	37	58,5	33	41	1-14
	315	315	405120	18-20	3/4	1/4	37,5	43,5	30	19	13/16-12
	250	250	405121	18-20	3/4	1/2	37,5	49	30	27	13/16-12
	200	200	405122	18-20	3/4	1	38	58,5	33	41	13/16-12
	315	315	405123	22-25	7/8-1	1/4	41,5	52	36	19	17/16-12
	250	250	405124	22-25	7/8-1	3/4	41,5	57,5	36	36	17/16-12
			405125	22-25	7/8-1	1 1/4	44,5	60,5	41	50	17/16-12
	200	200	405126	28-30-32	1 1/4	1	44,5	60,5	41	41	1 11/16-12
			405127	28-30-32	1 1/4	1 1/2	48,5	64	48	55	1 11/16-12

Notes: If you wish to order a fitting in stainless steel, please change the first two digit from 40.... to 41....

Series ORFS	40.... [bar]	41.... [bar]	Ordering Complete	Ø Tube M	Ø Tube W	M	L1	L2	CH1	CH2	ORFS
UNIVERSAL	315	315	405201	6	1/4	12x1,5	21,5	33	14	17	9/16-18
			405202	8-10	5/16-3/8	14x1,5	25	35,5	19	19	11/16-16
			405203	12	1/2	18x1,5	28	41	19	24	13/16-16
	250	250	405204	14-15-16	5/8	22x1,5	33,5	49	27	27	1-14
			405205	18-20	3/4	27x2	37,5	55,5	30	32	13/16-12
			405206	22-25	7/8-1	33x2	41,5	59,5	36	41	17/16-12
	160	160	405207	28-30-32	1 1/4	42x2	44,5	63	41	50	1 11/16-12
			405208	35-38	1 1/2	48x2	49	68,5	48	55	2-12
			405209	6	1/4	10x1	21,5	30	14	14	9/16-18
	315	315	405210	8-10	5/16-3/8	16x1,5	25	37,5	19	22	11/16-16
			405211	12	1/2	16x1,5	28	37,5	19	22	13/16-16
			405212	12	1/2	22x1,5	31,5	49	27	27	13/16-16
	315	315	405213	14-15-16	5/8	18x1,5	33,5	47,5	27	24	1-14
	250	250	405214	14-15-16	5/8	27x2	33,5	55,5	27	32	1-14
			405215	18-20	3/4	22x1,5	37,5	49,5	30	27	13/16-12
	160	160	405216	18-20	3/4	33x2	38	59,5	33	41	13/16-12
	250	250	405217	22-25	7/8-1	27x2	41,5	59,5	36	32	17/16-12
			405218	22-25	7/8-1	42x2	44,5	63	41	50	17/16-12
	160	160	405219	28-30-32	1 1/4	48x2	48,5	68,5	48	55	1 11/16-12

Notes: If you wish to order a fitting in stainless steel, please change the first two digit from 40.... to 41....

ADJUSTABLE MALE STUD ELBOW WITH O-RING

Thread UNF/UN-2A

Type: 4053..

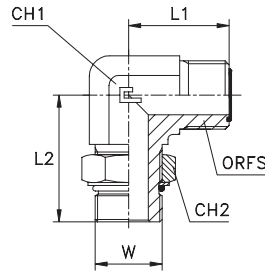

Series ORFS	40.... [bar]	41.... [bar]	Ordering Complete	Ø Tube M	Ø Tube W	W	L1	L2	CH1	CH2	ORFS
UNIVERSAL	420	420	405301	6	1/4	7/16-20	21,5	32,5	14	14	9/16-18
			405302	8-10	5/16-3/8	9/16-18	25	37	19	17	11/16-16
			405303	12	1/2	3/4-16	28	40,5	19	22	13/16-16
			405304	14-15-16	5/8	7/8-14	33,5	50	27	27	1-14
			405305	18-20	3/4	1 1/16-12	37,5	55	30	32	1 3/16-12
	380	380	405306	22-25	7/8-1	1 5/16-12	41,5	59,5	36	41	1 7/16-12
	280	280	405307	28-30-32	1 1/4	1 5/8-12	44,5	62	41	50	1 11/16-12
			405308	35-38	1 1/2	1 7/8-12	49	66	48	55	2-12
	420	420	405309	6	1/4	9/16-18	21,5	34,5	14	17	9/16-18
			405310	6	1/4	3/4-16	23,5	40,5	19	22	9/16-18
			405311	8-10	5/16-3/8	7/16-20	25	35	19	14	11/16-16
			405312	8-10	5/16-3/8	3/4-16	25	40,5	19	22	11/16-16
			405313	8-10	5/16-3/8	7/8-14	28	50	22	27	11/16-16
			405314	8-10	5/16-3/8	1 1/16-12	29,5	55	27	32	11/16-16
			405315	12	1/2	9/16-18	28	37	19	17	13/16-16
			405316	12	1/2	7/8-14	30	50	22	27	13/16-16
			405317	12	1/2	1 1/16-12	31,5	55	27	32	13/16-16
			405318	14-15-16	5/8	3/4-16	33,5	46	27	22	1-14
			405319	14-15-16	5/8	1 1/16-12	33,5	55	27	32	1-14
			405320	18-20	3/4	3/4-16	37,5	47	30	22	1 3/16-12
			405321	18-20	3/4	7/8-14	37,5	51	30	27	1 3/16-12
			380	380	405322	18-20	3/4	1 5/16-12	38	59,5	33
	420	420	405323	22-25	7/8-1	1 1/16-12	41,5	59	36	32	1 7/16-12
	280	280	405324	22-25	7/8-1	1 5/8-12	44,5	62	41	50	1 7/16-12
			405325	28-30-32	1 1/4	1 5/16-12	44,5	62	41	41	1 11/16-12
			405326	28-30-32	1 1/4	1 7/8-12	48,5	66	48	55	1 11/16-12
			405327	35-38	1 1/2	1 5/8-12	49	66	48	50	2-12

Notes: If you wish to order a fitting in stainless steel, please change the first two digit from 40.... to 41....

45° ADJUSTABLE MALE STUD ELBOW WITH O-RING AND WASHER

Thread BSP Parallel

Type: 4054..

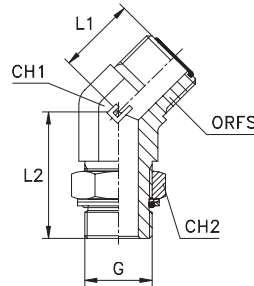

Series	40.... [bar]	41.... [bar]	Ordering Complete	Ø Tube M	Ø Tube W	G	L1	L2	CH1	CH2	ORFS
UNIVERSAL	350	350	405401	6	1/4	1/8	16	27,5	14	14	9/16-18
	315	315	405402	8-10	5/16-3/8	1/4	19	32,5	19	19	11/16-16
	250	250	405403	12	1/2	3/8	20,5	33,5	19	22	13/16-16
			405404	14-15-16	5/8	1/2	23,5	43	27	27	1-14
			405405	18-20	3/4	3/4	26	46,5	30	36	13/16-12
	200	200	405406	22-25	7/8-1	1	30	51	36	41	17/16-12
			405407	28-30-32	1 1/4	1 1/4	32	52,5	41	50	111/16-12
	160	160	405408	35-38	1 1/2	1 1/2	37	52,5	48	55	2-12
	315	315	405409	6	1/4	1/4	16	31,5	14	19	9/16-18
	250	250	405410	6	1/4	3/8	17,5	33,5	19	22	9/16-18
			405411	8-10	5/16-3/8	3/8	19	33,5	19	22	11/16-16
			405412	8-10	5/16-3/8	1/2	20	43	22	27	11/16-16
	315	315	405413	12	1/2	1/4	20,5	32,5	19	19	13/16-16
	250	250	405414	12	1/2	1/2	21	43	22	27	13/16-16
			405415	12	1/2	3/4	21,5	46,5	27	36	13/16-16
	315	315	405416	14-15-16	5/8	1/4	23,5	36	27	19	1-14
	250	250	405417	14-15-16	5/8	3/8	23,5	37	27	22	1-14
			405418	14-15-16	5/8	3/4	23,5	46,5	27	36	1-14
	200	200	405419	14-15-16	5/8	1	28,5	51	33	41	1-14
	315	315	405420	18-20	3/4	1/4	26	40,5	30	19	13/16-12
	250	250	405421	18-20	3/4	1/2	26	44,5	30	27	13/16-12
	200	200	405422	18-20	3/4	1	29,5	51	33	41	13/16-12
	315	315	405423	22-25	7/8-1	1/4	30	41	36	19	17/16-12
	250	250	405424	22-25	7/8-1	3/4	30	47	36	36	17/16-12
			405425	22-25	7/8-1	1 1/4	32	52,5	41	50	17/16-12
	200	200	405426	28-30-32	1 1/4	1	32	52,5	41	41	111/16-12
			405427	28-30-32	1 1/4	1 1/2	35,5	52,5	48	55	111/16-12

Notes: If you wish to order a fitting in stainless steel, please change the first two digit from 40.... to 41....

45° ADJUSTABLE MALE STUD ELBOW WITH O-RING

Thread UNF/UN-2A

Type: 4056..

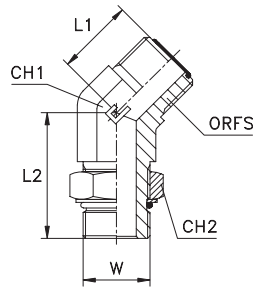

Series ORFS	40.... [bar]	41.... [bar]	Ordering Complete	Ø Tube M	Ø Tube W	W	L1	L2	CH1	CH2	ORFS
UNIVERSAL	420	420	405601	6	1/4	7/16-20	16	30	14	14	9/16-18
			405602	8-10	5/16-3/8	9/16-18	19	33	19	17	11/16-16
			405603	12	1/2	3/4-16	20,5	36,5	19	22	13/16-16
			405604	14-15-16	5/8	7/8-14	23,5	45	27	27	1-14
			405605	18-20	3/4	1 1/16-12	26	50	30	32	13/16-12
	380	380	405606	22-25	7/8-1	15/16-12	30	52,5	36	41	17/16-12
	280	280	405607	28-30-32	1 1/4	15/8-12	32	53,5	41	50	111/16-12
			405608	35-38	1 1/2	1 7/8-12	37	53,5	48	55	2-12
	420	420	405609	6	1/4	9/16-18	16	33	14	17	9/16-18
			405610	6	1/4	3/4-16	17,5	36,5	19	22	9/16-18
			405611	8-10	5/16-3/8	7/16-20	19	31	19	14	11/16-16
			405612	8-10	5/16-3/8	3/4-16	19	36,5	19	22	11/16-16
			405613	8-10	5/16-3/8	7/8-14	20	45	22	27	11/16-16
			405614	8-10	5/16-3/8	1 1/16-12	19,5	50	27	32	11/16-16
			405615	12	1/2	9/16-18	20,5	32,5	19	17	13/16-16
			405616	12	1/2	7/8-14	21	45	22	27	13/16-16
			405617	12	1/2	1 1/16-12	21,5	50	27	32	13/16-16
			405618	14-15-16	5/8	3/4-16	23,5	40,5	27	22	1-14
			405619	14-15-16	5/8	1 1/16-12	23,5	50	27	32	1-14
			405620	18-20	3/4	3/4-16	26	40,5	30	22	13/16-12
			405621	18-20	3/4	7/8-14	26	46	30	27	13/16-12
	380	380	405622	18-20	3/4	15/16-12	29,5	52,5	33	41	13/16-12
	420	420	405623	22-25	7/8-1	1 1/16-12	30	51,5	36	32	17/16-12
	280	280	405624	22-25	7/8-1	15/8-12	32	53,5	41	50	17/16-12
			405625	28-30-32	1 1/4	15/16-12	32	53,5	41	41	111/16-12
			405626	28-30-32	1 1/4	1 7/8-12	35,5	53,5	48	55	111/16-12
			405627	35-38	1 1/2	15/8-12	37	53,5	48	50	2-12

Notes: If you wish to order a fitting in stainless steel, please change the first two digit from 40.... to 41....

ADJUSTABLE MALE STUD BARREL TEE WITH O-RING AND WASHER

Thread BSP Parallel

Type: 4057..

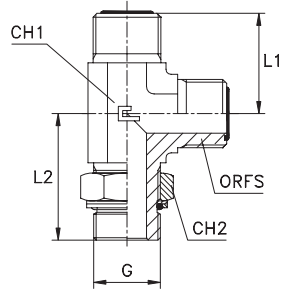

Series ORFS	40.... [bar]	41.... [bar]	Ordering Complete	Ø Tube M	Ø Tube W	G	L1	L2	CH1	CH2	ORFS
UNIVERSAL	350	350	405701	6	1/4	1/8	21,5	30	14	14	9/16-18
	315	315	405702	8-10	5/16-3/8	1/4	25	37	19	19	11/16-16
	250	250	405703	12	1/2	3/8	28	38	19	22	13/16-16
			405704	14-15-16	5/8	1/2	33,5	48	27	27	1-14
	200	200	405705	18-20	3/4	3/4	37,5	51,5	30	36	13/16-12
			405706	22-25	7/8-1	1	41,5	58,5	33	41	17/16-12
	160	160	405707	28-30-32	1 1/4	1 1/4	44,5	60,5	41	50	1 11/16-12
			405708	35-38	1 1/2	1 1/2	49	64	48	55	2-12
	315	315	405709	6	1/4	1/4	21,5	35	14	19	9/16-18
	250	250	405710	6	1/4	3/8	23,5	38	19	22	9/16-18
			405711	8-10	5/16-3/8	3/8	25	38	19	22	11/16-16
			405712	8-10	5/16-3/8	1/2	28	48	22	27	11/16-16
	315	315	405713	12	1/2	1/4	28	37	19	19	13/16-16
	250	250	405714	12	1/2	1/2	30	48	22	27	13/16-16
			405715	12	1/2	3/4	31,5	51,5	27	36	13/16-16
	315	315	405716	14-15-16	5/8	1/4	33,5	42,5	27	19	1-14
	250	250	405717	14-15-16	5/8	3/8	33,5	42,5	27	22	1-14
			405718	14-15-16	5/8	3/4	33,5	51,5	27	36	1-14
	200	200	405719	14-15-16	5/8	1	37	58,5	33	41	1-14
	315	315	405720	18-20	3/4	1/4	37,5	43,5	30	19	13/16-12
	250	250	405721	18-20	3/4	1/2	37,5	49	30	27	13/16-12
	200	200	405722	18-20	3/4	1	38	58,5	33	41	13/16-12
	315	315	405723	22-25	7/8-1	1/4	41,5	52	36	19	17/16-12
	250	250	405724	22-25	7/8-1	3/4	41,5	57,5	36	36	17/16-12
			405725	22-25	7/8-1	1 1/4	44,5	60,5	41	50	17/16-12
	200	200	405726	28-30-32	1 1/4	1	44,5	60,5	41	41	1 11/16-12
			405727	28-30-32	1 1/4	1 1/2	48,5	64	48	55	1 11/16-12

Notes: If you wish to order a fitting in stainless steel, please change the first two digit from 40.... to 41....

ADJUSTABLE MALE STUD BARREL TEE WITH O-RING

Thread UNF/UN-2A

Type: 4059..

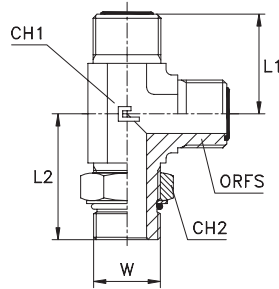

Series ORFS	40... [bar]	41... [bar]	Ordering Complete	Ø Tube M	Ø Tube W	W	L1	L2	CH1	CH2	ORFS
UNIVERSAL	420	420	405901	6	1/4	7/16-20	21,5	32,5	14	14	9/16-18
			405902	8-10	5/16-3/8	9/16-18	25	37	19	17	11/16-16
			405903	12	1/2	3/4-16	28	40,5	19	22	13/16-16
			405904	14-15-16	5/8	7/8-14	33,5	50	27	27	1-14
	380	380	405905	18-20	3/4	1 1/16-12	37,5	55	30	32	13/16-12
			405906	22-25	7/8-1	15/16-12	41,5	59,5	36	41	17/16-12
	280	280	405907	28-30-32	1 1/4	15/8-12	44,5	62	41	50	11/16-12
			405908	35-38	1 1/2	1 7/8-12	49	66	48	55	2-12
	420	420	405909	6	1/4	9/16-18	21,5	34,5	14	17	9/16-18
			405910	6	1/4	3/4-16	23,5	40,5	19	22	9/16-18
			405911	8-10	5/16-3/8	7/16-20	25	35	19	14	11/16-16
			405912	8-10	5/16-3/8	3/4-16	25	40,5	19	22	11/16-16
			405913	8-10	5/16-3/8	7/8-14	28	50	22	27	11/16-16
			405914	8-10	5/16-3/8	1 1/16-12	29,5	55	27	32	11/16-16
			405915	12	1/2	9/16-18	28	37	19	17	13/16-16
			405916	12	1/2	7/8-14	30	50	22	27	13/16-16
			405917	12	1/2	1 1/16-12	31,5	55	27	32	13/16-16
			405918	14-15-16	5/8	3/4-16	33,5	46	27	22	1-14
			405919	14-15-16	5/8	1 1/16-12	33,5	55	27	32	1-14
			405920	18-20	3/4	3/4-16	37,5	47	30	22	13/16-12
			405921	18-20	3/4	7/8-14	37,5	51	30	27	13/16-12
			380	380	405922	18-20	3/4	15/16-12	38	59,5	33
	420	420	405923	22-25	7/8-1	1 1/16-12	41,5	59	36	32	17/16-12
	280	280	405924	22-25	7/8-1	15/8-12	44,5	62	41	50	17/16-12
			405925	28-30-32	1 1/4	15/16-12	44,5	62	41	41	11/16-12
			405926	28-30-32	1 1/4	1 7/8-12	48,5	66	48	55	11/16-12
			405927	35-38	1 1/2	15/8-12	49	66	48	50	2-12

Notes: If you wish to order a fitting in stainless steel, please change the first two digit from 40.... to 41....

ADJUSTABLE MALE STUD BRANCH TEE WITH O-RING AND WASHER

Thread BSP Parallel

Type: 4060..

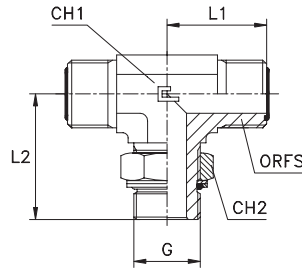

Series ORFS	40.... [bar]	41.... [bar]	Ordering Complete	Ø Tube M	Ø Tube W	G	L1	L2	CH1	CH2	ORFS
UNIVERSAL	350	350	406001	6	1/4	1/8	21,5	30	14	14	9/16-18
	315	315	406002	8-10	5/16-3/8	1/4	25	37	19	19	11/16-16
	250	250	406003	12	1/2	3/8	28	38	19	22	13/16-16
			406004	14-15-16	5/8	1/2	33,5	48	27	27	1-14
			406005	18-20	3/4	3/4	37,5	51,5	30	36	13/16-12
	200	200	406006	22-25	7/8-1	1	41,5	58,5	36	41	17/16-12
			406007	28-30-32	1 1/4	1 1/4	44,5	60,5	41	50	1 11/16-12
	160	160	406008	35-38	1 1/2	1 1/2	49	64	48	55	2-12
	315	315	406009	6	1/4	1/4	21,5	35	14	19	9/16-18
			406010	6	1/4	3/8	23,5	38	19	22	9/16-18
	250	250	406011	8-10	5/16-3/8	3/8	25	38	19	22	11/16-16
			406012	8-10	5/16-3/8	1/2	28	48	22	27	11/16-16
	315	315	406013	12	1/2	1/4	28	37	19	19	13/16-16
	250	250	406014	12	1/2	1/2	30	48	22	27	13/16-16
			406015	12	1/2	3/4	31,5	51,5	27	36	13/16-16
	315	315	406016	14-15-16	5/8	1/4	33,5	42,5	27	19	1-14
	250	250	406017	14-15-16	5/8	3/8	33,5	42,5	27	22	1-14
			406018	14-15-16	5/8	3/4	33,5	51,5	27	36	1-14
	200	200	406019	14-15-16	5/8	1	37	58,5	33	41	1-14
	315	315	406020	18-20	3/4	1/4	37,5	43,5	30	19	13/16-12
	250	250	406021	18-20	3/4	1/2	37,5	49	30	27	13/16-12
	200	200	406022	18-20	3/4	1	38	58,5	33	41	13/16-12
	315	315	406023	22-25	7/8-1	1/4	41,5	52	36	19	17/16-12
	250	250	406024	22-25	7/8-1	3/4	41,5	57,5	36	36	17/16-12
			406025	22-25	7/8-1	1 1/4	44,5	60,5	41	50	17/16-12
	200	200	406026	28-30-32	1 1/4	1	44,5	60,5	41	41	1 11/16-12
			406027	28-30-32	1 1/4	1 1/2	48,5	64	48	55	1 11/16-12

Notes: If you wish to order a fitting in stainless steel, please change the first two digit from 40.... to 41.... .

ADJUSTABLE MALE STUD BRANCH TEE WITH O-RING

Thread UNF/UN-2A

Type: 4062..

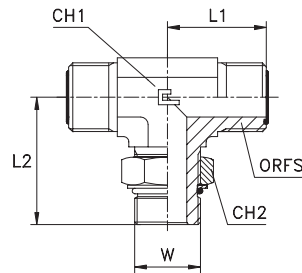

Series ORFS	40.... [bar]	41.... [bar]	Ordering Complete	Ø Tube M	Ø Tube W	W	L1	L2	CH1	CH2	ORFS		
UNIVERSAL	420	420	406201	6	1/4	7/16-20	21,5	32,5	14	14	9/16-18		
			406202	8-10	5/16-3/8	9/16-18	25	37	19	17	11/16-16		
			406203	12	1/2	3/4-16	28	40,5	19	22	13/16-16		
			406204	14-15-16	5/8	7/8-14	33,5	50	27	27	1-14		
			406205	18-20	3/4	1 1/16-12	37,5	55	30	32	13/16-12		
	380	380	406206	22-25	7/8-1	15/16-12	41,5	59,5	36	41	17/16-12		
	280	280	406207	28-30-32	1 1/4	15/8-12	44,5	62	41	50	11 1/16-12		
			406208	35-38	1 1/2	17/8-12	49	66	48	55	2-12		
	420	420	406209	6	1/4	9/16-18	21,5	34,5	14	17	9/16-18		
			406210	6	1/4	3/4-16	23,5	40,5	19	22	9/16-18		
			406211	8-10	5/16-3/8	7/16-20	25	35	19	14	11/16-16		
			406212	8-10	5/16-3/8	3/4-16	25	40,5	19	22	11/16-16		
			406213	8-10	5/16-3/8	7/8-14	28	50	22	27	11/16-16		
			406214	8-10	5/16-3/8	1 1/16-12	29,5	55	27	32	11/16-16		
			406215	12	1/2	9/16-18	28	37	19	17	13/16-16		
			406216	12	1/2	7/8-14	30	50	22	27	13/16-16		
			406217	12	1/2	1 1/16-12	31,5	55	27	32	13/16-16		
			406218	14-15-16	5/8	3/4-16	33,5	46	27	22	1-14		
			406219	14-15-16	5/8	1 1/16-12	33,5	55	27	32	1-14		
			406220	18-20	3/4	3/4-16	37,5	47	30	22	13/16-12		
			406221	18-20	3/4	7/8-14	37,5	51	30	27	13/16-12		
			380	380	406222	18-20	3/4	15/16-12	38	59,5	33	41	13/16-12
			420	420	406223	22-25	7/8-1	1 1/16-12	41,5	59	36	32	17/16-12
	406224	22-25			7/8-1	15/8-12	44,5	62	41	50	17/16-12		
	280	280	406225	28-30-32	1 1/4	15/16-12	44,5	62	41	41	11 1/16-12		
			406226	28-30-32	1 1/4	17/8-12	48,5	66	48	55	11 1/16-12		
			406227	35-38	1 1/4	15/8-12	49	66	48	50	2-12		

Notes: If you wish to order a fitting in stainless steel, please change the first two digit from 40.... to 41....

ADJUSTABLE MALE STUD ELBOW WITH CRIMPED NUT, O-RING AND WASHER

Thread BSP Parallel

Type: **4069..**

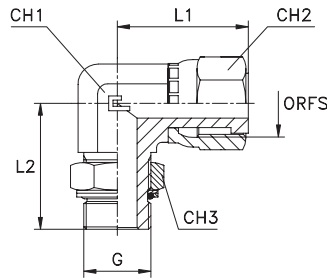

Series ORFS	40.... [bar]	41.... [bar]	Ordering Complete	Ø Tube M	Ø Tube W	G	L1	L2	CH1	CH2	CH3	ORFS
UNIVERSAL	350	350	406901	6	1/4	1/8	26,5	30	14	19	14	9/16-18
	315	315	406902	8-10	5/16-3/8	1/4	29	37	19	22	19	11/16-16
	250	250	406903	12	1/2	3/8	38	38	19	24	22	13/16-16
			406904	14-15-16	5/8	1/2	41	48	27	30	27	1-14
	200	200	406905	18-20	3/4	3/4	46,5	51,5	30	36	36	13/16-12
			406906	22-25	7/8-1	1	53,5	58,5	36	46	41	17/16-12
	160	160	406907	28-30-32	1 1/4	1 1/4	58	60,5	41	50	50	11/16-12
			406908	35-38	1 1/2	1 1/2	61	64	48	60	55	2-12

Notes: If you wish to order a fitting in stainless steel, please change the first two digit from **40....** to **41....** .

ADJUSTABLE MALE STUD ELBOW WITH CRIMPED NUT AND O-RING

Thread UNF/UN-2A

Type: **4071..**

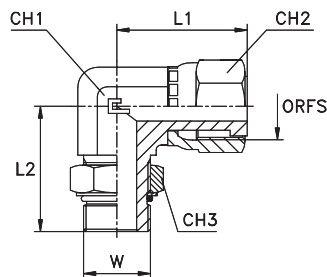

Series ORFS	40.... [bar]	41.... [bar]	Ordering Complete	Ø Tube M	Ø Tube W	W	L1	L2	CH1	CH2	CH3	ORFS
UNIVERSAL	420	420	407101	6	1/4	7/16-20	26,5	32,5	14	19	14	9/16-18
			407102	8-10	5/16-3/8	9/16-18	29	37	19	22	17	11/16-16
			407103	12	1/2	3/4-16	38	40,5	19	24	22	13/16-16
			407104	14-15-16	5/8	7/8-14	41	50	27	30	27	1-14
			407105	18-20	3/4	1 1/16-12	46,5	55	30	36	32	13/16-12
	380	380	407106	22-25	7/8-1	15/16-12	53,5	59,5	36	46	41	17/16-12
	280	280	407107	28-30-32	1 1/4	15/8-12	58	62	41	50	50	11/16-12
			407108	35-38	1 1/2	17/8-12	61	66	48	60	55	2-12

Notes: If you wish to order a fitting in stainless steel, please change the first two digit from **40....** to **41....** .

CRIMPED NUT ELBOW

Type: 4072..

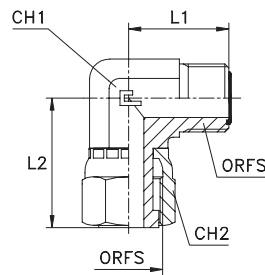

Series ORFS	40.... [bar]	41.... [bar]	Ordering Complete	Ø Tube M	Ø Tube W	L1	L2	CH1	CH2	ORFS
UNIVERSAL	630	630	407201	6	1/4	21,5	26,5	14	19	9/16-18
			407202	8-10	5/16-3/8	25	29	19	22	11/16-16
			407203	12	1/2	28	38	19	24	13/16-16
	420	420	407204	14-15-16	5/8	33,5	41	27	30	1-14
			407205	18-20	3/4	37,5	46,5	30	36	13/16-12
			407206	22-25	7/8-1	41,5	53,5	36	46	17/16-12
	280	280	407207	28-30-32	1 1/4	44,5	58	41	50	1 11/16-12
			407208	35-38	1 1/2	49	61	48	60	2-12

Notes: If you wish to order a fitting in stainless steel, please change the first two digit from 40.... to 41.... .

CRIMPED NUT 45° ELBOW

Type: 4073..

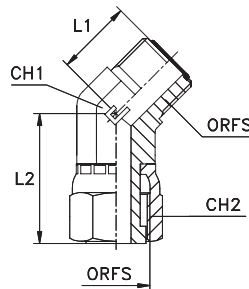

Series ORFS	40.... [bar]	41.... [bar]	Ordering Complete	Ø Tube M	Ø Tube W	L1	L2	CH1	CH2	ORFS
UNIVERSAL	630	630	407301	6	1/4	16	25	14	19	9/16-18
			407302	8-10	5/16-3/8	19	28	19	22	11/16-16
			407303	12	1/2	20,5	33,5	19	24	13/16-16
	420	420	407304	14-15-16	5/8	23,5	39	27	30	1-14
			407305	18-20	3/4	26	44	30	36	13/16-12
			407306	22-25	7/8-1	30	47,5	36	46	17/16-12
	280	280	407307	28-30-32	1 1/4	32	50	41	50	1 11/16-12
			407308	35-38	1 1/2	37	52	48	60	2-12

Notes: If you wish to order a fitting in stainless steel, please change the first two digit from 40.... to 41.... .

CRIMPED NUT BARREL TEE

Type: 4074..

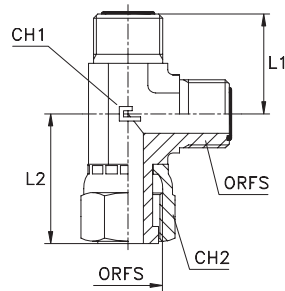

Series ORFS	40.... [bar]	41.... [bar]	Ordering Complete	Ø Tube M	Ø Tube W	L1	L2	CH1	CH2	ORFS
UNIVERSAL	630	630	407401	6	1/4	21,5	26,5	14	19	9/16-18
			407402	8-10	5/16-3/8	25	29	19	22	11/16-16
			407403	12	1/2	28	38	19	24	13/16-16
	420	420	407404	14-15-16	5/8	33,5	41	27	30	1-14
			407405	18-20	3/4	37,5	46,5	30	36	13/16-12
			407406	22-25	7/8-1	41,5	53,5	36	46	17/16-12
	280	280	407407	28-30-32	1 1/4	44,5	58	41	50	1 11/16-12
			407408	35-38	1 1/2	49	61	48	60	2-12

Notes: If you wish to order a fitting in stainless steel, please change the first two digit from 40.... to 41.... .

CRIMPED NUT BRANCH TEE

Type: 4075..

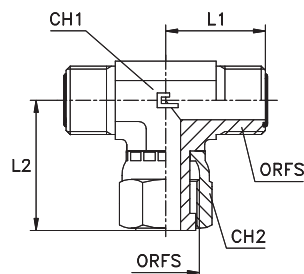

Series ORFS	40.... [bar]	41.... [bar]	Ordering Complete	Ø Tube M	Ø Tube W	L1	L2	CH1	CH2	ORFS
UNIVERSAL	630	630	407501	6	1/4	21,5	26,5	14	19	9/16-18
			407502	8-10	5/16-3/8	25	29	19	22	11/16-16
			407503	12	1/2	28	38	19	24	13/16-16
	420	420	407504	14-15-16	5/8	33,5	41	27	30	1-14
			407505	18-20	3/4	37,5	46,5	30	36	13/16-12
			407506	22-25	7/8-1	41,5	53,5	36	46	17/16-12
	280	280	407507	28-30-32	1 1/4	44,5	58	41	50	1 11/16-12
			407508	35-38	1 1/2	49	61	48	60	2-12

Notes: If you wish to order a fitting in stainless steel, please change the first two digit from 40.... to 41.... .

FEMALE PLUG

Thread UNF/UN-2B

Type: 4076..

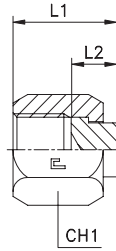

Series ORFS	40.... [bar]	41.... [bar]	Ordering Complete	Ø Tube M	Ø Tube W	L1	L2	CH1	ORFS
UNIVERSAL	630	630	407601	6	1/4	16,5	8,5	17	9/16-18
			407602	8-10	5/16-3/8	18	9,5	22	11/16-16
			407603	12	1/2	22	12	24	13/16-16
	420	420	407604	14-15-16	5/8	24,5	12	30	1-14
			407605	18-20	3/4	27	13,5	36	13/16-12
			407606	22-25	7/8-1	28,5	15	41	17/16-12
	280	280	407607	28-30-32	1 1/4	28,5	15	50	1 11/16-12
			407608	35-38	1 1/2	28,5	15	60	2-12

Notes: If you wish to order AISI 316 stainless steel fittings, please change the first two digits from 40.... to 41....
 If you wish to order AISI 316 stainless steel fittings with AISI 304 stainless steel nuts, please change the first two digits from 40.... to 44....

PIPE PLUG

Thread UNF/UN-2A

Type: 4077..

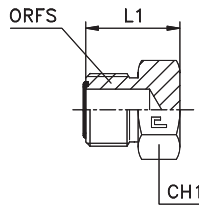

Series ORFS	40.... [bar]	41.... [bar]	Ordering Complete	Ø Tube M	Ø Tube W	L1	CH1	ORFS
UNIVERSAL	630	630	407701	6	1/4	16,5	17	9/16-18
			407702	8-10	5/16-3/8	19	19	11/16-16
			407703	12	1/2	22	22	13/16-16
	420	420	407704	14-15-16	5/8	26	27	1-14
			407705	18-20	3/4	27,5	32	13/16-12
			407706	22-25	7/8-1	28	41	17/16-12
	280	280	407707	28-30-32	1 1/4	28	46	1 11/16-12
			407708	35-38	1 1/2	28	55	2-12

Notes: If you wish to order a fitting in stainless steel, please change the first two digit from 40.... to 41....

EXAGONAL NUT

Thread UNF/UN-2B

Type: 4078..

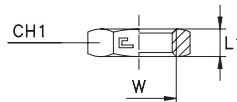

Series ORFS	40.... [bar]	41.... [bar]	Ordering Complete	Ø Tube M	Ø Tube W	L1	CH1	ORFS
UNIVERSAL	630	630	207603	6	1/4	7	22	9/16-18
			407802	8-10	5/16-3/8	8	27	11/16-16
			407803	12	1/2	9	30	13/16-16
	420	420	407804	14-15-16	5/8	10,5	36	1-14
			407805	18-20	3/4	10,5	41	13/16-12
			407806	22-25	7/8-1	10,5	46	17/16-12
	280	280	407807	28-30-32	1 1/4	10,5	50	1 11/16-12
			407808	35-38	1 1/2	10,5	60	2-12

Notes: If you wish to order a fitting in stainless steel, please change the first two digit from 40.... to 41....

PRODUCTION PLANT no. 3 OF CASALGRASSO (CN)

Production plant of CAST S.p.A.





ISO 12151
SAE J516



4

AVAILABLE IN CARBON AND STAINLESS STEEL

ORIGINS OF THE PRESS FITTING

To fully understand the innovative content of the new Series C4 it is necessary to analyze the theory of operation of the traditional Series 70.... often named the “Italian version”, which has been on the market for several decades without any substantial innovation.

In the Series 70.... the mechanism of connection between the flexible tube, the fitting for the tube and the sleeve to crimp was basically split into two different parts faced separately: the fastening of the flexible tube and the seal of the fluid.

In the external part the crimping of the sleeve (both skive and no-skive) would allow the barbs of the sleeve to make contact with the metal threads of the rubber tube to create the fastening between the sleeve, the rubber tube and the fitting body in order to stop pull-out under pressure. In addition the crushing of the sleeve, in the internal part of the coupling, allowed the barb of the fitting body with its stepped geometry to collapse and occupy the substrate of the rubber tube to seal potential leakages.

In practical terms in the traditional project three different components are featured (separate sleeve, tube and fitting body), which solve the two problems of fastening and sealing independently from each other. Given a geometry that is substantially identical in the sleeve barb and the fitting body, while pressing, the sleeve carries out the crimping of the tube and simply compresses the tube on the barbs of the fitting body to provide the necessary seal. Nevertheless the natural deformation of the sleeve only follows the logic of fastening to the tube and the compression of the material is in charge of creating the seal.

So we have a situation where the two problems are treated as one consequent to the other or vice versa, without a real integrated solution.

The innovative idea is not to deal with the two issues in a separate manner but rather as a single integrated project so to optimise the possible synergies.

The project, as shown in the drawings, was started to find a definitive solution to both requirements by integrating the various characteristics in order to obtain a unique and definitive solution to implement the technical improvements offered by engineering.

For this reason the interlocking geometry of the sleeve is much more performing, as it uses the geometry of the barb of the fitting body to guarantee a better fastening, creating an important safety synergy; on the other hand, the geometry of the fitting body, not being stressed by the compression of the crimping, increases the sealing of the substrate, which is less mechanically strained; at the same time, the wave shape obtained absorbs vibrations, a typical problem of this type of application, thus significantly reducing the wear of the system in general.

To obtain this result, if on one side it was necessary to dimension the barbs and their position on the fitting body so to guarantee a perfect interchangeability with the previous product, the dimensions, the angles and the positioning of the sleeve barbs have required an in-depth study to obtain the perfect interlocking system between the two geometries after the deformations of the crimping. In fact, far from being equally distributed, the barbs of the different sleeve families, and also those in the same family but with different diameters, have been carefully positioned to obtain the mentioned result, researching the perfect positioning once crimping is done.

To complete the project, the “stop-tube” technical solution was applied to all the newly manufactured sleeves to make the assembly more user friendly.

The Mission

ACCIDENT PREVENTION

•

ENVIRONMENTAL PROTECTION

•

PRODUCT RESPONSIBILITY

•

ENERGY CONSUMPTION REDUCTION

•

LEAKAGE-FREE TUBE ASSEMBLIES

•

OIL-LESS ASSEMBLIES

•

SYSTEM CONTROL IN CASE OF HARSH
WORKING CONDITIONS:
PRESSURE, VIBRATIONS AND HIGH
TEMPERATURES

MARKET REQUIREMENTS:

DUST-DRY SEALING

SIMPLE AND CONSOLIDATED ASSEMBLY
RECOGNISABLE PRODUCT

The Target

The evolution of the press fitting system for high pressure flexible tubes, with a scheduled plan of research, development, innovation and industrialisation of the product, finalised to obtain the international industrial patent.

•
Leakage and oil free connections even in especially harsh working conditions in terms of pressure, vibrations and high temperatures, within the set limits.

•
Improvement of the seal by creating a construction geometry that increases the number of contact points in the substrate of the rubber tube to be sufficient to obtain a dust dry seal.

•
Consolidated assembly made without complications using the same tools used for the existing assembly.

•
Widespread distribution on the market of the new press fitting for high pressure flexible tubes of the Series C4, reliable, pull-out resistant, with a constructive technology, providing state-of-the-art safe crimping.

•
Full product traceability via traceability coding.

•
Full interchangeability with products existing on the market.

•
Customer satisfaction.

•
Possible use with carbon and stainless steel.

•
Rationalised use of resources for an improved social impact.

The Benefits

SAFETY

Tube pull-out resistance thanks to the clinching system.

•

Dust dry sealing due to more sealing points.

•

Vibration absorption thanks to variable wave geometry.

•

Product traceability via traceability coding.

TECHNICS

Complete interchangeability with products existing on the market.

•

Assembly carried out with normally used tools.

•

Possible use with carbon and stainless steel.

COSTS

Peace of mind for having used one of the best technologies in the industry.

•

Preventing accidents to people, the environment, systems and the image of the company.

•

Contributing to containing the national energy deficit.















•

Safeguarding the environment and the quality of life in the country for future generations.

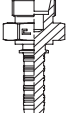
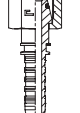
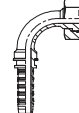

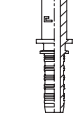
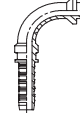
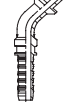
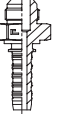
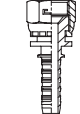
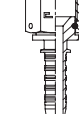
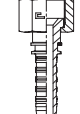
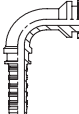
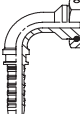
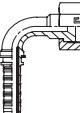
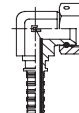
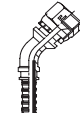
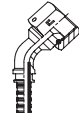
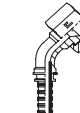
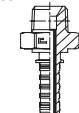
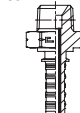
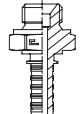
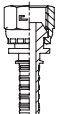
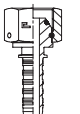
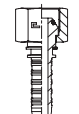
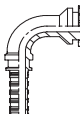
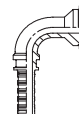
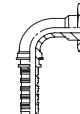
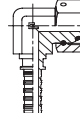
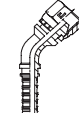
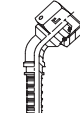
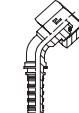
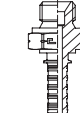
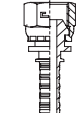
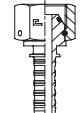
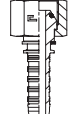
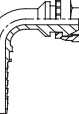
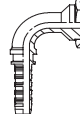
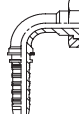
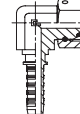
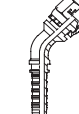
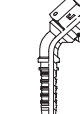
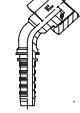
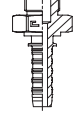
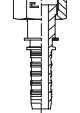
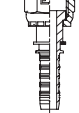
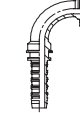
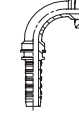
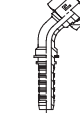
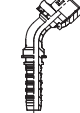

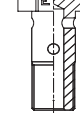
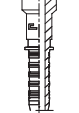
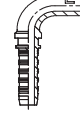
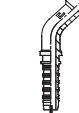





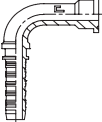

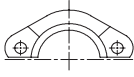
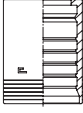
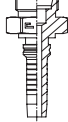
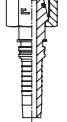
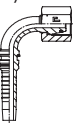
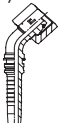
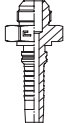
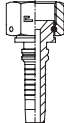
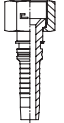

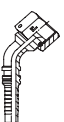
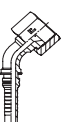
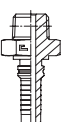
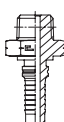
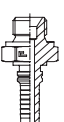
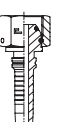
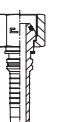
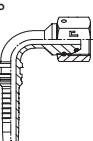
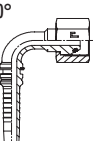

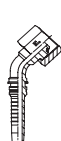
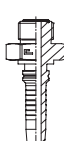
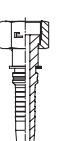
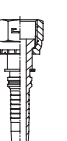
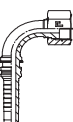
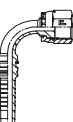
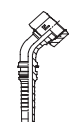
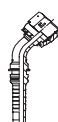
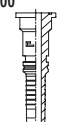



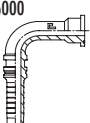
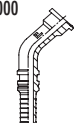

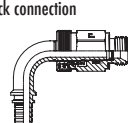
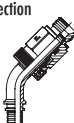









•

International patent pending.

FIGURATIVE INDEX – FITTINGS SAE J516 - ISO 12151

General instructions	Quality assurance	Allowed temperatures	Finish treatments	Tubes to be used	Threaded ends	Prescriptions to comply with
Utilisation standards	Safety factors	Seals on threads	End treatments	Tables follow up	Gas - Metric UNF - NPT	Assembly instructions
Page 277	Page 22-277	Page 23	Page 24	Page 25-26	Page 27-32	Page 33; 276-292
Code: 8001 .. 1SN-R1AT - 2SC skive 	Code: 8002 .. 2SN-R2AT skive 	Code: 8003 .. 1SN-R1AT - 2SC no skive 	Code: 8004 .. 2SN-R2AT no skive 	Code: 8005.. 1SN-R1AT - 2SN-R2AT 2SC no skive 	Code: 8005..-COMP 1SC no skive 	Code: 8006 .. 4SP-4SH skive 
Page 293	Page 293	Page 294	Page 294	Page 295	Page 295	Page 296
Code: 8008.. R7 - R7TM no skive 	Code: 8009.. 24° series L/S 	Code: 8010.. 24° series L/S 	Code: 8011.. 24° series L/S 	Code: 8011.. 24° series L/S Code: 8012.. 24° series L/S 	Code: 8013.. Standpipe series L/S 	Code: 8014.. Standpipe series L/S 
Page 296	Page 297	Page 298	Page 299	Page 300	Page 301	Page 302
Code: 8015.. Standpipe series L/S 	Code: 8016.. JIC 37° 	Code: 8017.. JIC 37° 	Code: 8018.. JIC 37° 	Code: 8018.. JIC 37° 	Code: 8019.. JIC 37° 	Code: 8020.. JIC 37° 
Page 303	Page 304	Page 305	Page 306	Page 306	Page 307	Page 308
Code: 8020.. JIC 37° 	Code: 8021.. JIC 37° 	Code: 8022.. JIC 37° 	Code: 8023.. JIC 37° 	Code: 8023.. JIC 37° 	Code: 8024.. BSPT 60° 	Code: 8025.. NPTF 60° 
Page 308	Page 309	Page 309	Page 310	Page 310	Page 311	Page 311
Code: 8026.. BSPP 60° 	Code: 8027.. BSPP 60° 	Code: 8028.. BSPP 60° 	Code: 8028.. BSPP 60° 	Code: 8029.. BSPP 60° 	Code: 8030.. BSPP 60° 	Code: 8030.. BSPP 60° 
Page 312	Page 313	Page 314	Page 314	Page 315	Page 316	Page 316
Code: 8031.. BSPP 60° 	Code: 8032.. BSPP 60° 	Code: 8033.. BSPP 60° 	Code: 8033.. BSPP 60° 	Code: 8034.. Metric Parallel 60° 	Code: 8035.. Metric Parallel 60° 	Code: 8036.. Metric Parallel 60° 
Page 317	Page 317	Page 318	Page 318	Page 319	Page 320	Page 321
Code: 8036.. Metric Parallel 60° 	Code: 8037.. Metric Parallel 60° 	Code: 8038.. Metric Parallel 60° 	Code: 8038.. Metric Parallel 60° 	Code: 8039.. Metric Parallel 60° 	Code: 8040.. Metric Parallel 60° 	Code: 8041.. Metric Parallel 60° 
Page 321	Page 322	Page 323	Page 323	Page 324	Page 324	Page 325
Code: 8041.. Metric Parallel 60° 	Code: 8042.. ORFD 	Code: 8043.. ORFD 	Code: 8043.. ORFD 	Code: 8044.. ORFD 	Code: 8044.. ORFD 	Code: 8045.. ORFD 
Page 325	Page 326	Page 326	Page 326	Page 327	Page 327	Page 327
Code: 8045.. ORFD 	Code: 8046.. Gas Code: 8047.. Metric 	Code: 8048.. Gas Code: 8049.. Metric 	Code: 8050.. Series 3000 	Code: 8051.. Series 3000 	Code: 8052.. Series 3000 	Code: 8053.. Series 6000 
Page 327	Page 328	Page 329	Page 330	Page 330	Page 331	Page 331

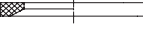
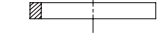
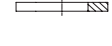
FIGURATIVE INDEX – FITTINGS SAE J516 - ISO 12151

Code: 8054.. Series 6000 	Code: 8055.. Series 6000 	Code: 8056.. S 3000 Code: 8057.. S 6000 	Code: 8058.. Interlock 4SH - 4SP - R13 	Code: 8059.. Interlock R13 	Code: 8060.. Interlock 24° series L/S 	Code: 8061.. Interlock 24° series L/S 
Page 332	Page 332	Page 333	Page 334	Page 334	Page 335	Page 335
Code: 8062.. Interlock 24° series L/S 	Code: 8063.. Interlock 24° series L/S 	Code: 8064.. Interlock JIC 37° 	Code: 8065.. Interlock JIC 37° 	Code: 8065.. Interlock JIC 37° 	Code: 8066.. Interlock JIC 37° 	Code: 8066.. Interlock JIC 37° 
Page 336	Page 336	Page 337	Page 337	Page 337	Page 338	Page 338
Code: 8067.. Interlock JIC 37° 	Code: 8067.. Interlock JIC 37° 	Code: 8068.. Interlock BSPT 	Code: 8069.. Interlock NPTF 	Code: 8070.. Interlock BSPP 60° 	Code: 8071.. Interlock BSPP 60°S 	Code: 8071.. Interlock BSPP 60° 
Page 338	Page 338	Page 339	Page 339	Page 340	Page 340	Page 340
Code: 8072.. Interlock BSPP 60° 	Code: 8072.. Interlock BSPP 60° 	Code: 8073.. Interlock BSPP 60° 	Code: 8073.. Interlock BSPP 60° 	Code: 8074.. Interlock ORFS 	Code: 8075.. Interlock ORFS 	Code: 8075.. Interlock ORFS 
Page 341	Page 341	Page 341	Page 341	Page 342	Page 342	Page 342
Code: 8076.. Interlock ORFS 	Code: 8076.. Interlock ORFS 	Code: 8077.. Interlock ORFS 	Code: 8077.. Interlock ORFS 	Code: 8078.. Interlock Series 3000 	Code: 8079.. Interlock Series 3000 	Code: 8080.. Interlock Series 3000 
Page 343	Page 343	Page 343	Page 343	Page 344	Page 344	Page 345
Code: 8081.. Interlock Series 6000 	Code: 8082.. Interlock Series 6000 	Code: 8083.. Interlock Series 6000 	Code: 8084.. Quick connection 	Code: 8085.. Quick connection 	Code: 8086.. Quick connection 	Code: 8087.. Quick connection 
Page 345	Page 346	Page 346	Page 347	Page 347	Page 347	Page 347
Code: 7301.. EN 853/1SN SAE 100 R1AT 	Code: 7302.. EN 853/2SN SAE 100 R2AT 	Code: 7305.. EN 857 1SC 	Code: 7306.. EN 857 2SC 	Code: 7314.. 1SC HIGH PRESSURE WATER JET WASHERS BLACK COVER 	Code: 7315.. 1SC HIGH PRESSURE WATER JET WASHERS BLUE COVER 	Code: 7316.. 2SC HIGH PRESSURE WATER JET WASHERS BLACK COVER 
Page 280	Page 280	Page 281	Page 281	Page 282	Page 282	Page 282
Code: 7317.. 2SC HIGH PRESSURE WATER JET WASHERS BLUE COVER 	Code: 7308.. EN 856/4SP 	Code: 7309.. EN 856/4SH 	Code: 7310.. EN 856/R13 	Code: 7311.. EN 855 R7 SAE 100 R7 	Code: 7312.. R7TM 	Code: STT-80.. CONTROL SWIVELS 
Page 283	Page 283	Page 284	Page 284	Page 285	Page 285	Page 348
Code: STS-80.. CONTROL SWIVELS 	Code: STM-80.. CONTROL SWIVELS 	Code: STSI CONTROL SWIVELS 	Code: 0301.. NBR Code: 0302.. Viton O-RING 	Code: 0303.. 0304.. NBR Code: 0305.. 0306.. Viton GASKETS 	Code: 0023.. Carbon Code: 0123.. St. steel CONT. RING 	Code: 0220.. Gas Code: 0221.. Metric COPPER RING 
Page 348	Page 348	Page 348	Page 349	Page 350	Page 351	Page 351
Code: 0320.. Gas Code: 0321.. Metric BONDED RING 	Compatible fluids table					
Page 351	Page 352+356	Page	Page	Page	Page	Page

ORDERING EXAMPLES (Carbon steel)

ORDERING EXAMPLES (Stainless steel)

HOSE FITTINGS

• If you require a stud coupling with slip-on nut, 24° cone or with O-Ring, O tube 15L, thread nut M22x1.5, for flexible tube DN10, order: 801019

• If you require to order the chosen fitting made of stainless steel, replace the number 80 with 81 in the initial code 801019

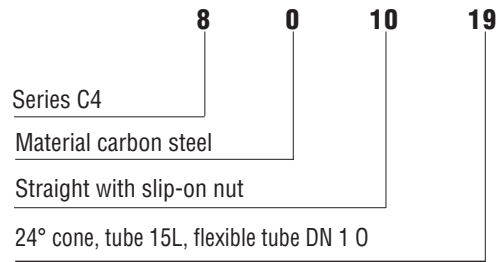

HOSE FITTINGS

• If you require a stud coupling with BSPP 3/8" stapled nut, for flexible tube DN1 0 and 60° cone, order: 802709

• If you require to order the chosen fitting made of stainless steel, replace the number 80 with 81 in the initial code, order: 812709

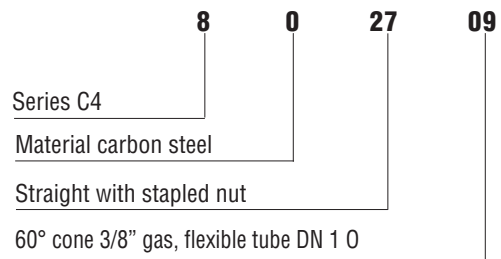

HOSE FITTINGS

• If you require a 45° fitting with BSPP 1/2" stapled nut, for flexible tube DN12 and 60° cone, order 803212

• If you require the chosen stainless steel fitting, replace the number 80 with 81 in the initial code 813212

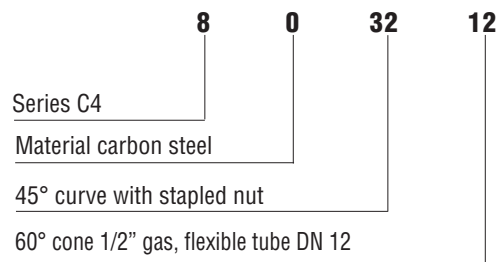

HOSE FITTINGS

• If you require a 90° fitting with BSPP 3/4" stapled nut, for flexible tube DN19 and 60° cone, order: 802917

• If you require the chosen stainless steel fitting, replace the number 80 with 81 in the initial code 812917

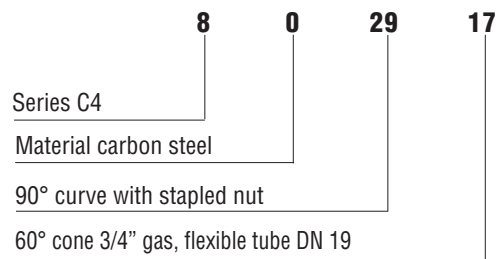

DELIVERIES

- Cast S.p.A. fittings are delivered in the configurations shown in the tables of this catalogue.
- Available on scheduled orders only: it means that the article is slow moving and will be delivered within 90 days.
- Available on request only: it means that the article is not commonly in stock; please contact our offices for further delivery details.

THEORY OF OPERATION (skive ferrule)

The CAST fitting for flexible hose of the Series C4 is a press fitting with multiple seal to be assembled on the hydraulic rubber hose compliant with EN 853, EN 856, EN 857, SAE J517 to obtain system connections. It helps fast assembly of removable hoses in the configurations needed to create complex high-performance oleo-dynamic systems.

While pressing the ferrule, its geometrical configuration compresses the external metal reinforcement of the flexible hose, engaging perfectly with the female geometry of the fitting body to obtain a perfect crimping of the components and increase the performance considerably.

HOSE FITTINGS COUPLING SYSTEM

Fitting body collapse

Traceability decoding:

CAST =
Logo of the
Manufacturer

• T =
Production plant

• 3 =
Year of manufacture

• CE =
Made in EEC

• 50 =
Type of steel used

• 01 =
Heat number
of the steel used

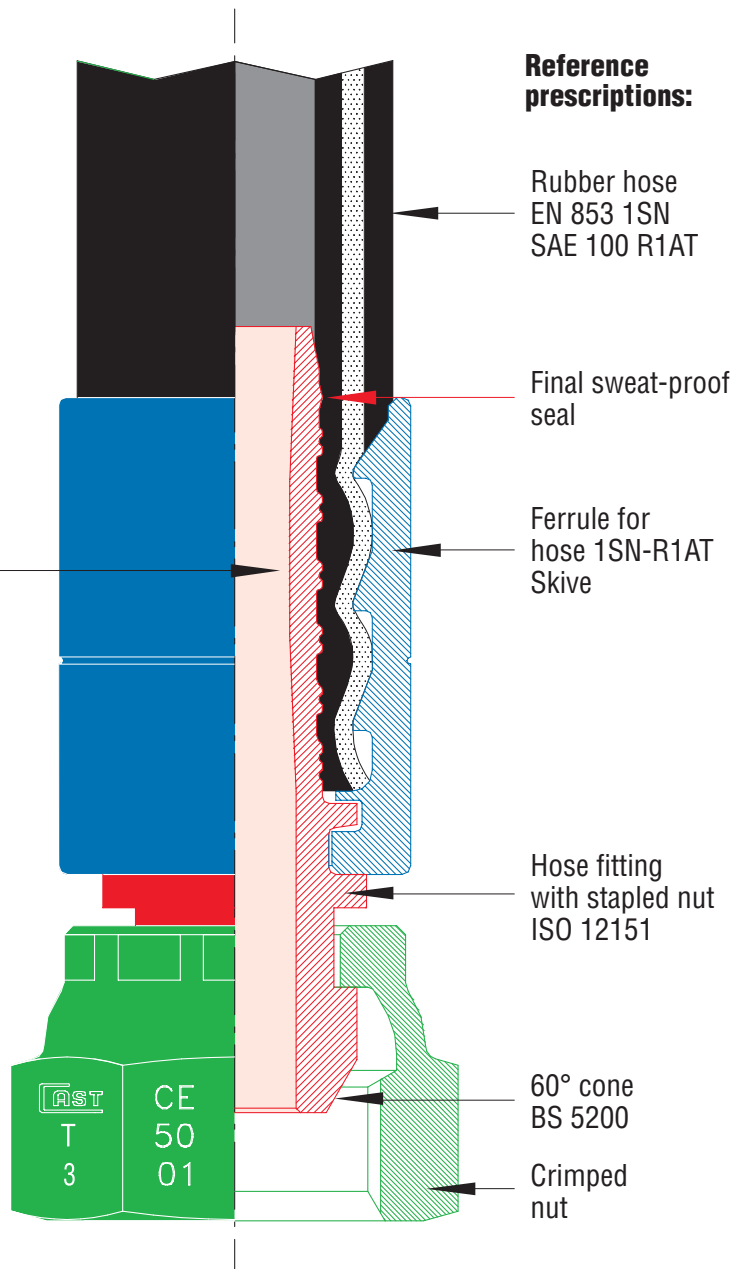

TECHNICAL CHARACTERISTICS (skive sleeve)

The CAST fitting for flexible hose of the Series C4 guarantees perfect tightness of the circuit regardless of the fluid used, provided that corrosive fluids are avoided and the nominal pressures and temperatures specified by the manufacturer are complied with. The male-female clinching system creates an innovative, state-of-the-art locking system that guarantees environmental protection and the safety of people and objects.

Normal vibrations do not alter the fitting's performance, which, even at maximum values, retains its characteristics of absolute reliability. The rubber hose to be assembled on the fittings must be strictly suitable for hydraulic applications, while it must be underlined that the hydraulic hoses with fittings have a limited life.

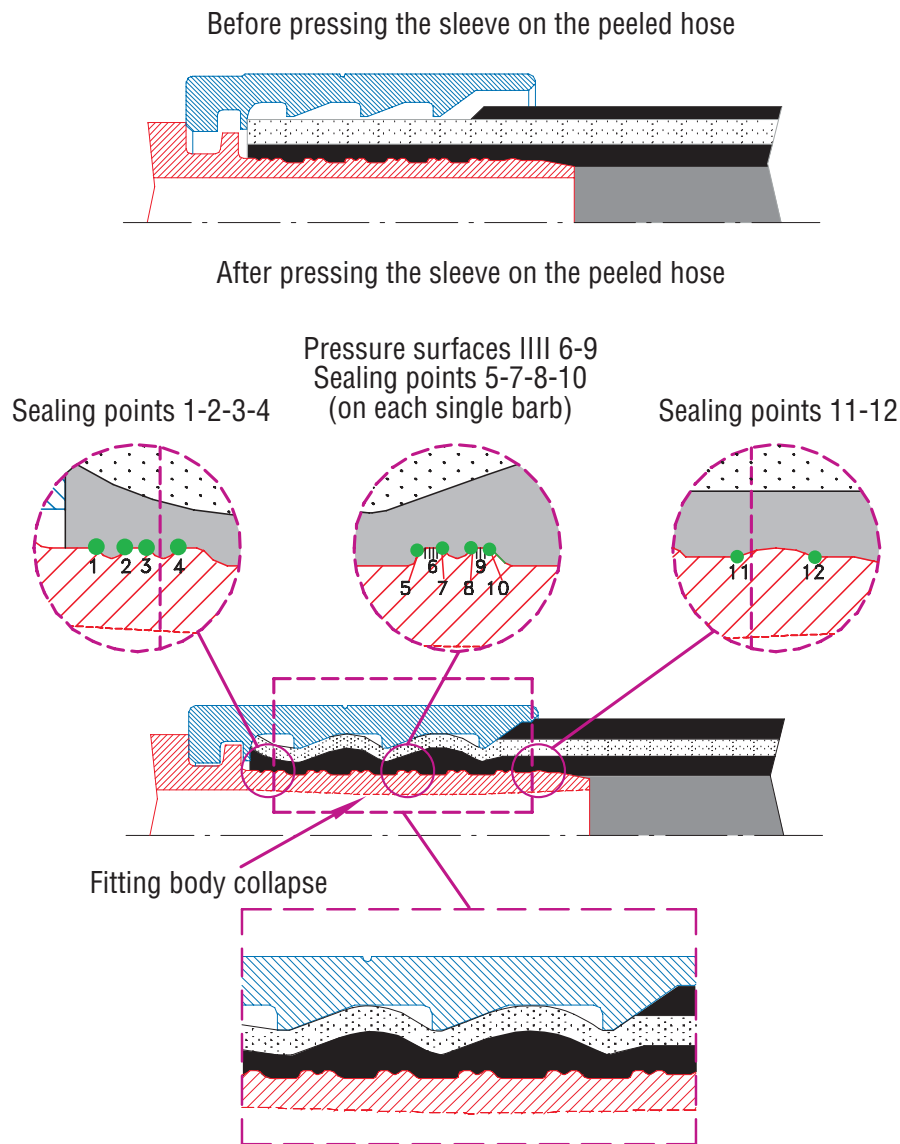

Multiple seal male-female crimping:
Safety **GUARANTEE** - Protecting the **ENVIRONMENT** - Enhancing the **PERFORMANCE**

TECHNICAL INNOVATION

For many years now there has been an increasing imperative market demand for fluid system components that guarantee three main factors:

SAFETY EASY ASSEMBLY LEAKAGE-FREE TIGHTNESS

These features, these days needed for the environmental and workplace safety (Leg. Decree 81/2008), as well as for product responsibility (Presidential Decree 224-EEC 85/374) and for the integrated ecological protection system have led us to develop this new series of products with the tube stop, adjustable geometry in the assembly phase, interlocking clinching and increased sealing points in the rubber substrate and the seal of the tube output from the sleeve.

THEORY OF OPERATION (NO skive ferrule)

The CAST fitting for flexible hose of the Series C4 is a press fitting with multiple seal to be assembled on the hydraulic rubber hose compliant with EN 853, EN 855, EN 857, SAE J517 to obtain system connections. It helps fast assembly of removable hose in the configurations needed to create complex high-performance oleo-dynamic systems.

While pressing the ferrule, its geometrical configuration compresses the external diameter of the flexible hose, engaging perfectly with the female geometry of the fitting body to obtain a perfect crimping of the components and increase the performance considerably.

HOSE FITTINGS COUPLING SYSTEM

Fitting body collapse

Traceability decoding:

CAST =
Logo of the
Manufacturer

- T =
Production plant
- 3 =
Year of manufacture
- CE =
Made in EEC
- 50 =
Type of steel used
- 01 =
Heat number
of the steel used

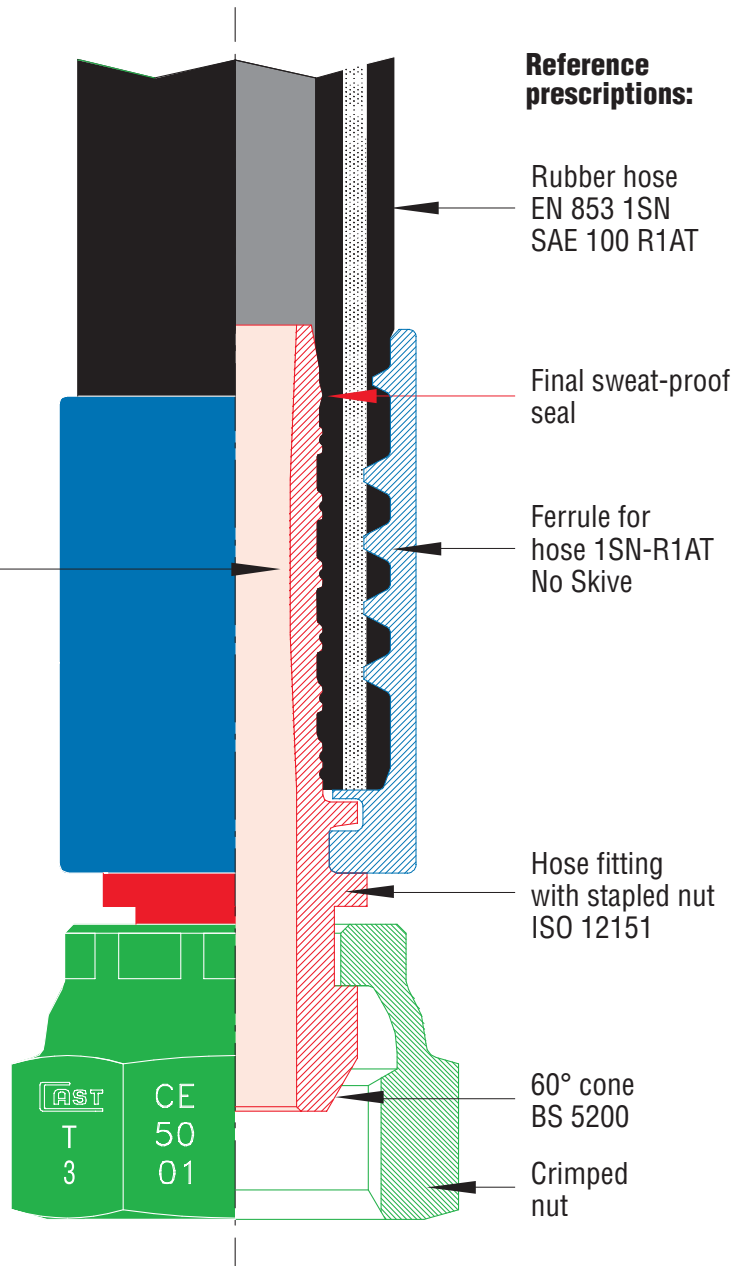

TECHNICAL CHARACTERISTICS (NO skive ferrule)

The CAST fitting for flexible hose of the Series C4 guarantees perfect tightness of the circuit regardless of the fluid used, provided that corrosive fluids are avoided and the nominal pressures and temperatures specified by the manufacturer are complied with. The male-female clinching system creates an innovative, state-of-the-art locking system that guarantees environmental protection and the safety of people and objects.

Normal vibrations do not alter the fitting's performance, which, even at maximum values, retains its characteristics of absolute reliability. The rubber hoses to be assembled on the fittings must be strictly suitable for hydraulic applications, while it must be underlined that the hydraulic hoses with fittings have a limited life.

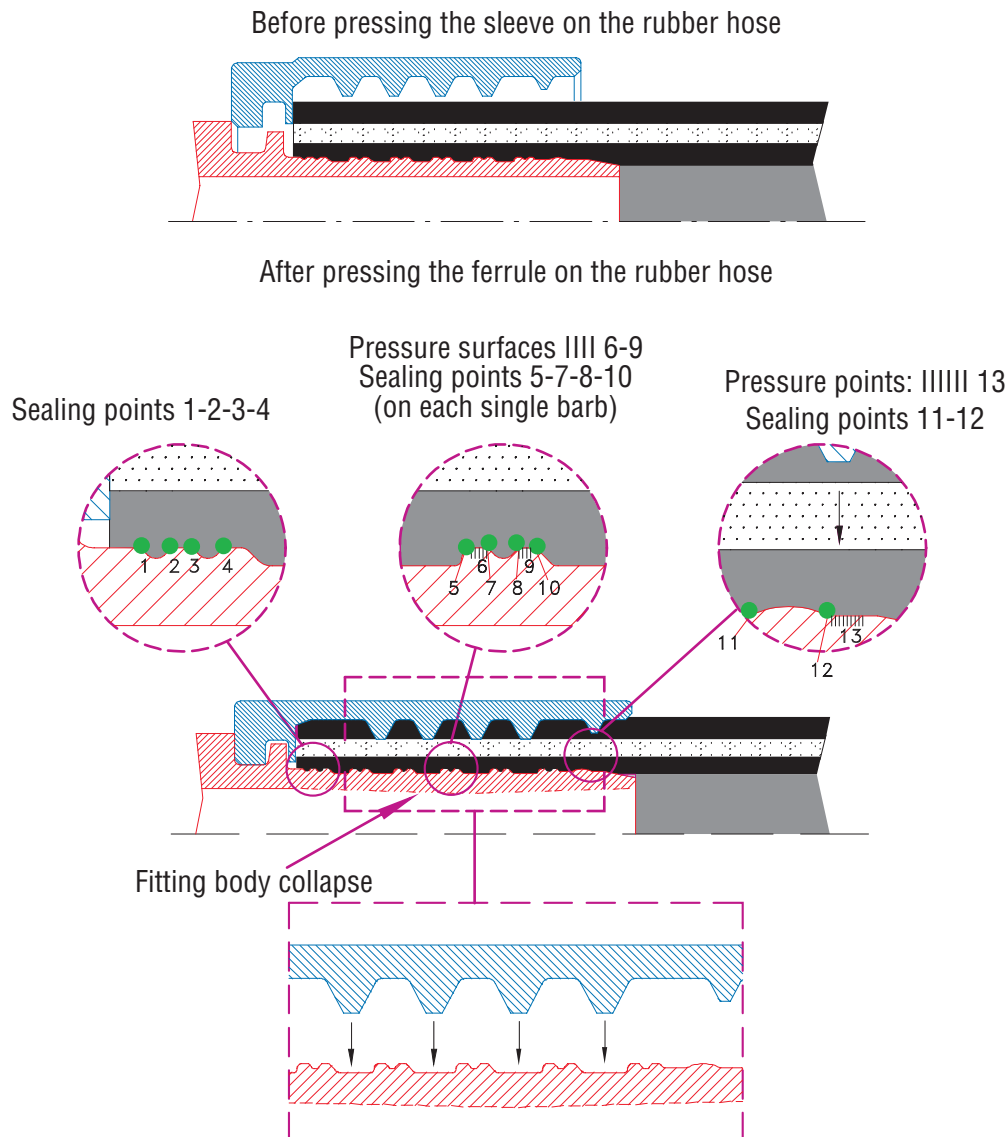

Multiple seal male-female crimping:
Safety **GUARANTEE** - Protecting the **ENVIRONMENT** - Enhancing the **PERFORMANCE**

TECHNICAL INNOVATION

For many years now there has been an increasing imperative market demand for fluid system components that guarantee three main factors:

SAFETY EASY ASSEMBLY LEAKAGE-FREE TIGHTNESS

These features, these days needed for the environmental and workplace safety (Leg. Decree 81/2008), as well as for product responsibility (Presidential Decree 224-EEC 85/374) and for the integrated ecological protection system have led us to develop this new series of products with the tube stop, adjustable geometry in the assembly phase, interlocking clinching and increased sealing points in the rubber substrate and an additional sealing point to protect the seal just before the tube output from the sleeve.

THEORY OF OPERATION (INTERLOCK)

The CAST fitting for flexible hose of the Series INTERLOCK is a press fitting with multiple seal to be assembled on the hydraulic rubber hose compliant with EN 856 to obtain system connections. It helps fast assembly of removable hoses in the configurations needed to create complex very high-performance hydraulic systems.

While pressing the ferrule, its geometrical configuration compresses the external metal reinforcement of the flexible tube, engaging perfectly with the female geometry of the fitting body to obtain a perfect coupling, which ensures the resistance to pressure peaks and serious stress, as part of the preset performance.

HOSE FITTINGS COUPLING SYSTEM

Fitting body
collapse

Traceability decoding:

CAST =
Logo of the
Manufacturer

- T =
Production plant
- 3 =
Year of manufacture
- CE =
Made in EEC
- 50 =
Type of steel used
- 01 =
Heat number
of the steel used

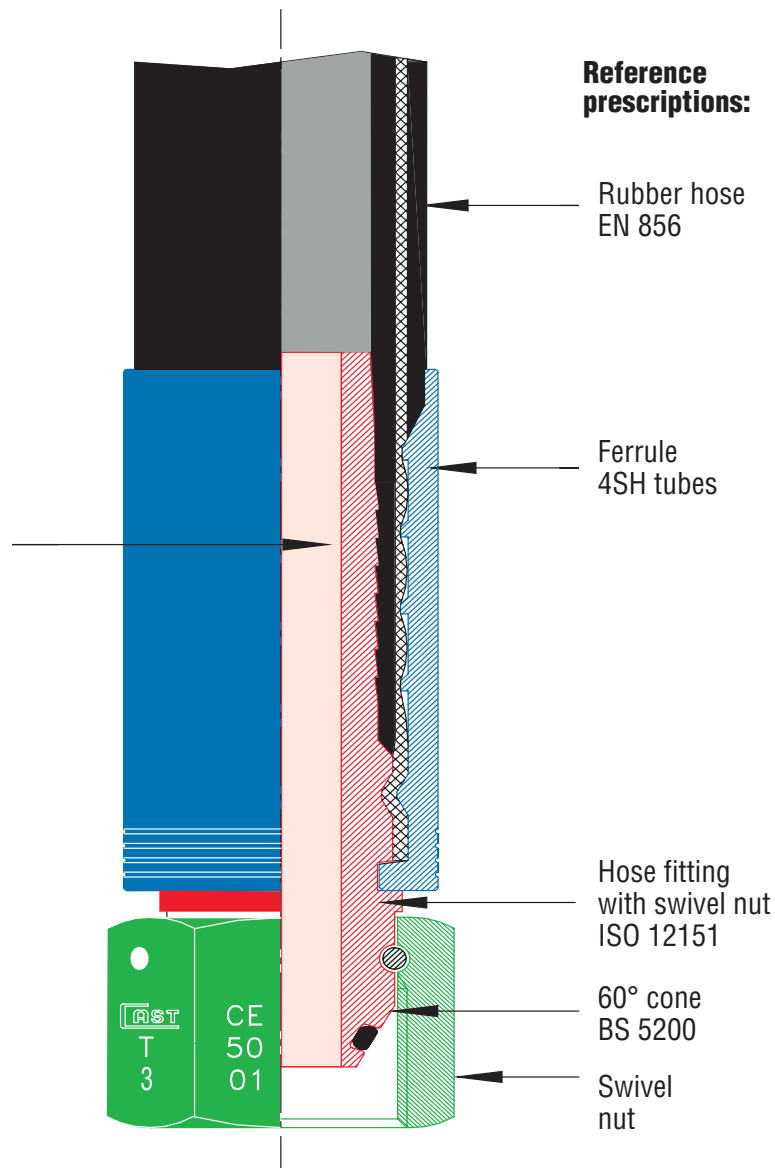

TECHNICAL CHARACTERISTICS (INTERLOCK)

The CAST fitting for flexible hose of the Series INTERLOCK guarantees perfect tightness of the circuit regardless of the fluid used, provided that corrosive fluids are avoided and the nominal pressures and temperatures specified by the manufacturer are complied with.

INTERLOCK fittings are to only be used with spiral wired flexible tubes type: 4SP, 4SH and R13 according to standard EN 856. The assembly includes skiving the hose, both internally and externally, in a way to create two specific seal areas.

The particular interlock coupling ensures a perfect interlocking clinching between the sleeve, tube reinforcement and insert, by creating a solid metal to metal clinching. Please see fig. 1.

During the pressing phase, the internal profile of the sleeve compresses the external metal reinforcement of the tube to obtain a mechanical seal between the hose and the sleeve (please see fig. 1), and a hydraulic seal between the tube substrate and insert. Please see fig. 2.

Normal vibrations and pulses do not alter the fitting's performance, which, even at maximum values, retains its characteristics of absolute reliability.

The rubber hoses to be assembled on the fittings must be strictly suitable for hydraulic applications, while it must be underlined that the hydraulic hoses with fittings have a limited life.

Before pressing the ferrule on the peeled hose

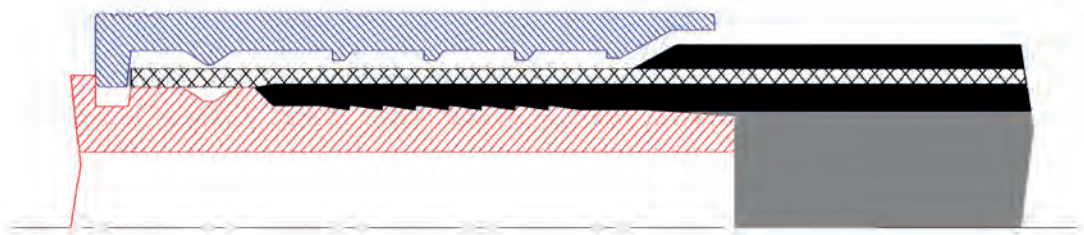

After pressing the ferrule on the peeled hose

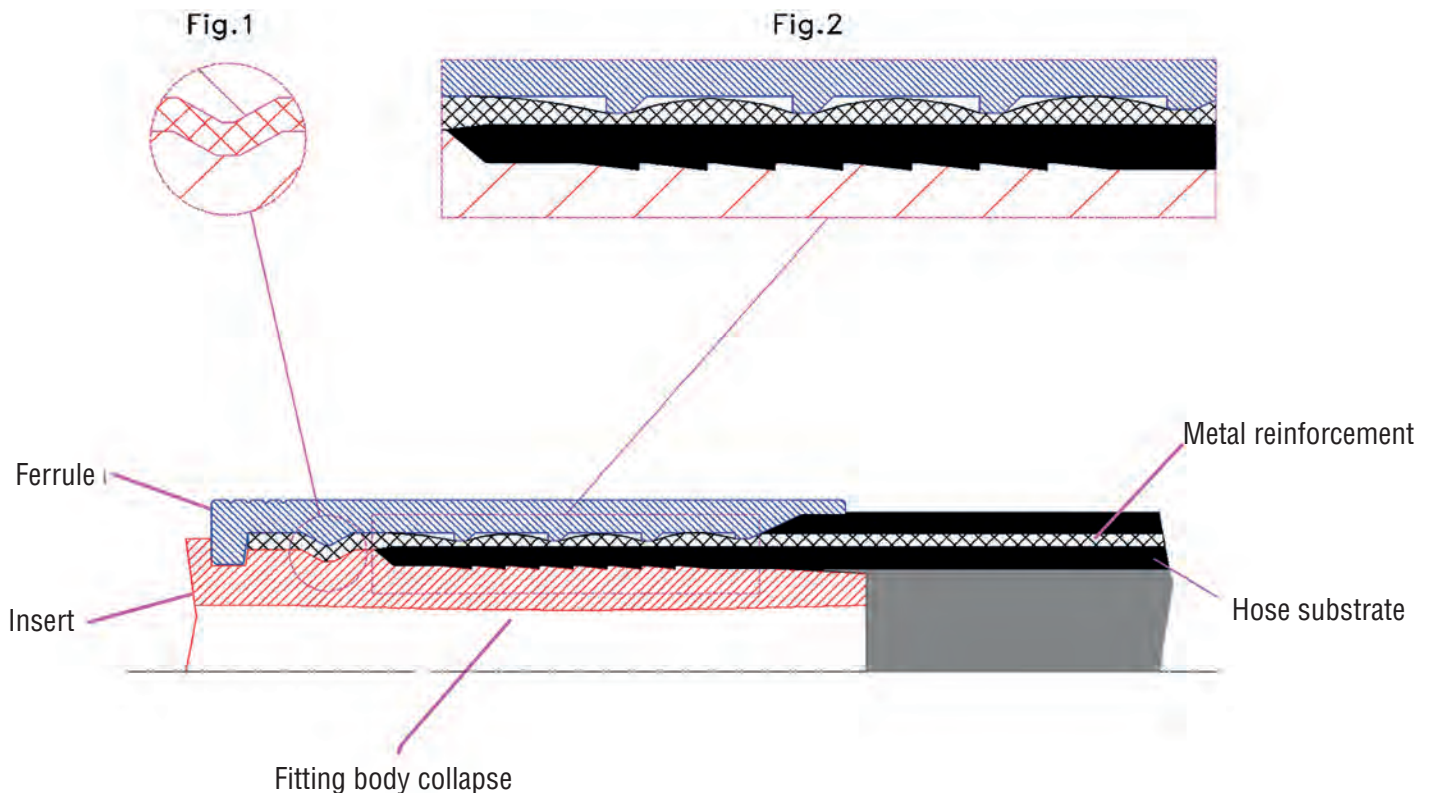

THEORY OF OPERATION (Quick connection)

The 80 quick connection is a new project of CAST S.p.A. aimed at reducing the time of assembly and disassembly of the flexible hoses on the hydraulic systems, thus reducing the time and costs required to replace tools onboard the machine.

This quick release fitting provides: quick assembly and disassembly, no need for tools or utensils, since it is sufficient to manually connect or disconnect the hose, simply acting on the mobile sleeve, which unlocks the sleeve release.

It eases and simplifies those maintenance interventions where, for dimension requirements, the hoses are mounted in battery or placed in areas inaccessible to iron roughnecks.

QUICK CONNECTION COUPLING SYSTEM

Fitting body
collapse

Traceability decoding:

CAST =
Logo of the
Manufacturer

- T =
Production plant
- 3 =
Year of manufacture
- CE =
Made in EEC
- 50 =
Type of steel used
- 01 =
Heat number
of the steel used

Reference prescriptions:

Rubber hose
EN 853 1SN
SAE 100 R1AT

Ferrule for
tube 1SN-R1AT

Unlocking
hexagonal nut

Insert
straight

Connection
body

Protection
filter

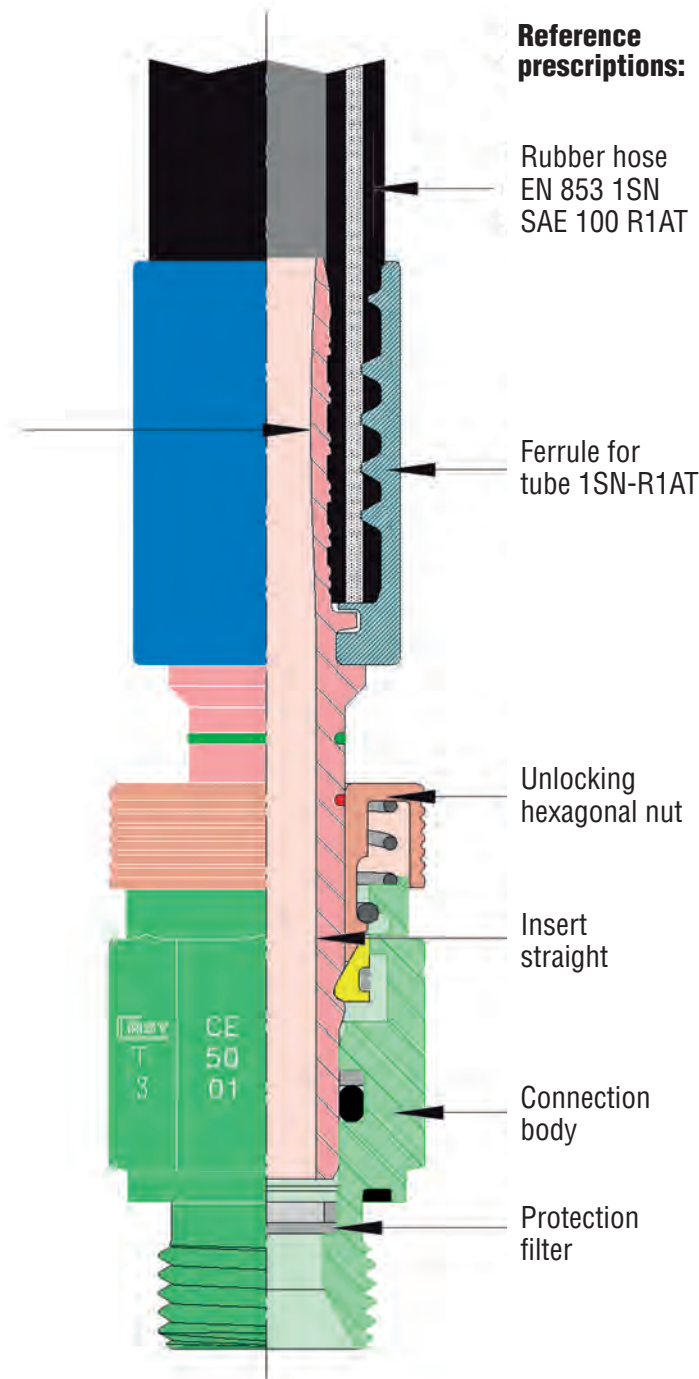

TECHNICAL CHARACTERISTICS (Quick connection)

The series 80 quick connection is a quick release fitting for high performance hydraulic flexible hoses. It ensures a perfect seal of the circuit, regardless of the fluid used, provided that corrosive fluids are avoided and the nominal pressures and temperatures specified by the manufacturer are complied with.

Special care was paid to the safety parameters to be applied to the product. Right from the design phase, a filter was arranged inside the connection body with the task of stopping the entry of foreign bodies in the circuit downstream of the fitting. This protects the set of valves, cylinders and actuators of the system from impurities, which would damage them.

MALE INSERT ASSEMBLY INSTRUCTIONS

- 1) Before the assembly, make sure that all the tools to be used are in perfect working order. It's forbidden to use any non-conform tool. Replace any inefficient tools.
- 2) Insert the male coupler in the connection body up to the stop. In this phase both green and red rings are not visible to the operator.
- 3) The check of the correct insertion must be performed on 100% of the connections by slightly pulling the male insert (Fig.2). →
- 4) If you see only the green ring is the confirmation that the assembly has been performed correctly and pressure may be applied to the system. Should you see the red ring it means that the connection has not been properly assembled and is forbidden to let pressure in. In this case the assembly procedure must be performed until only the green ring is visible.
- 5) The disengagement cannot take not place casually, as this is prevented by the same pressure. The disengagement of the male connector may only take place by voluntarily pressing the unlocking sleeve (Fig. 3).
- 6) It's forbidden to unlock the male insert from the connection body before having completely emptied the system from pressure.

ENGAGEMENT PHASE

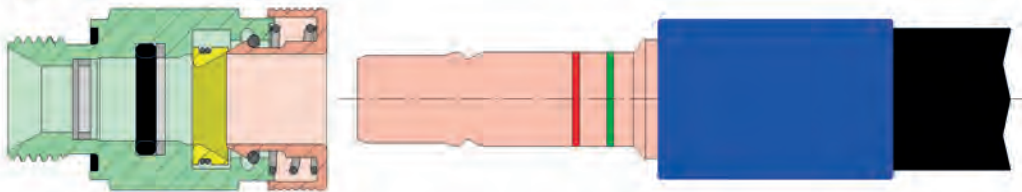

Fig. 1

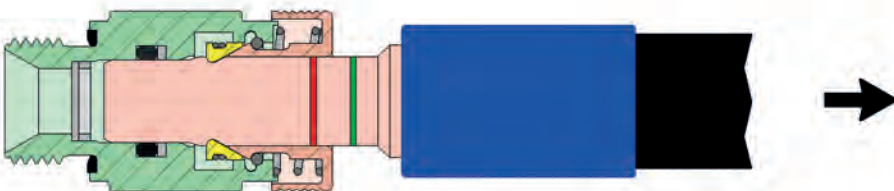

Fig. 2

DISENGAGEMENT PHASE

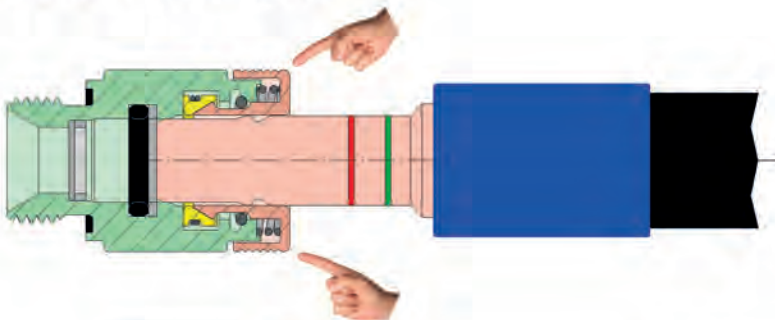

Fig. 3

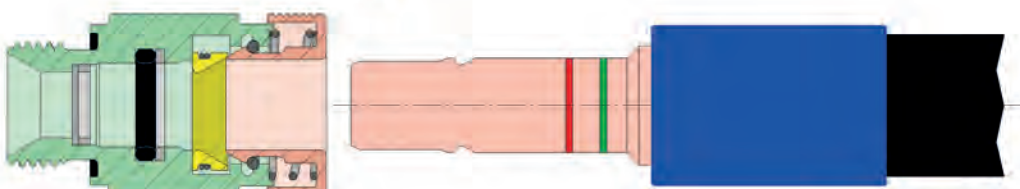

Fig. 4

SAFETY FACTORS (Skive-No Skive-Interlock-Quick connection)

- The press fittings for high pressure flexible tubes of the CAST S.p.A. Series C4 solve the problem of safety through the interlocking clinching and automatic locking (obtained via a particular geometry of the sleeve and the fitting body). While making the fastening safer, we also set a precise mechanical limit for the crimping of the tube to give certainty of correct operation.
- The CAST production fully respects the construction parameters of the reference standards.
- The nominal working pressures (bar) given in the catalogue indicate the maximum permissible pressures (including pressure peaks). For higher pressure the items must be tested in accordance with the manufacturer for specific applications.
- It is imperative to thoroughly check the collapse of the fitting hole (insert) with the prescribed P-NP buffers. In case of curves, it is fundamental to obtain reference samples by cutting the fitting body at the base of the curve and carry out the check with the abovementioned buffers. Based on the samples obtained as so, it is possible to proceed to the serial crimping. Repeat this operation periodically to ascertain the compliance with the parameters.
- The user must duly consider, for the purpose of a correct maintenance, that:

THE HOSES OF THE HYDRAULIC HOSES FITTED ARE PARTS WITH A LIMITED LIFE

- The safety factor 4:1 is intended with static load and with the temperature at the indicated values and according to the pressures referred to in standards EN 853, EN 855, EN 856, EN 857, SAE J517, ISO 12151.
- The flexible hose must be necessarily fastened with a safety chain or protected by a guard to prevent striking the operator in case it becomes disengaged.
- It is understood that our reliable products are only guaranteed if the interconnection is made entirely with our products and components; please see traceability codes.

PRODUCT CONCEPT (Skive-No Skive-Quick connection)

The most original aspect of the product is the male-female geometry with multiple seal. The new product goes one step beyond the known techniques and solves right from the start the problem of minor losses of tightness, leaks, sweating and safety of the crimping. The dimensional optimisation, innovative geometry and use of materials and treatments purposefully studied for the production of this series of products have allowed us to create an improved state-of-the-art product that is safe, respects the environment and ensures optimal performance.

HIGH SEALING (Skive-No Skive-Quick connection)

The partition of the sealing surfaces lets us optimise the hose, sleeve and fitting coupling by creating the conditions to obtain a truly exceptional seal, from a crimping and seal point of view. The sealed points of the new product were tripled compared to the previous product, confirming the CONTINUOUS IMPROVEMENT of technology research and the development and innovation of our company, always committed to projects directed at future technology to protect the environment.

GENERAL INSTRUCTIONS (Skive-No Skive-Interlock-Quick connection)

Before starting the crimping of the sleeves to the hydraulic hose, check that the sleeves are of the dimensions suitable for the tube that you want to use, considering the pressures you intend to use, and check that the tube has not expired and has no defects. Check that the fitting body has no defects, and carefully insert it into the hole without damaging the inside of the hose, until the point of its natural stop, then proceed with the pressing by carefully observing the sleeve pressing diameters provided by the fitting manufacturer. It is imperative to thoroughly check the collapse of the fitting hole with the prescribed P-NP buffers to ensure the actual crimping between the hose, insert and sleeve. Before fastening the preassembled tube to the system onboard the machine, check the entire hose has no defects. If in doubt choose the most conservative and safest solution.

UTILISATION STANDARDS (Skive -No Skive -Interlock -Quick connection)

High quality tubes must be employed to assure correct use and related technical performance of the fitting. The use of hoses without the aforementioned characteristics may seriously impair the efficiency of the fitting, affecting its correct performance.

INTERCHANGEABILITY AND CODING (Skive-No Skive)

The new CAST S.p.A. series of press fittings is perfectly interchangeable with the previous series 70 , also for individual components. The previous series 70 will be regularly supplied while stocks last and then automatically replaced by the new series 80

CHOICE OF FLEXIBLE HOSE SIZE

The graph below can be used for the correct choice of the flexible hose. It lets you calculate the tube dimension according to the flow value and speed of the fluid.

To find out the dimension of the right hose, draw a straight line connecting the known values of flow and speed. The intersection of this line on the middle of the picture determines the value of the diameter of the hose to be chosen. In case the value found does not correspond with one of the diameters DN indicated, the highest value must be chosen. Use the speeds suggested for intake and return pressure systems, to always have optimal working conditions.

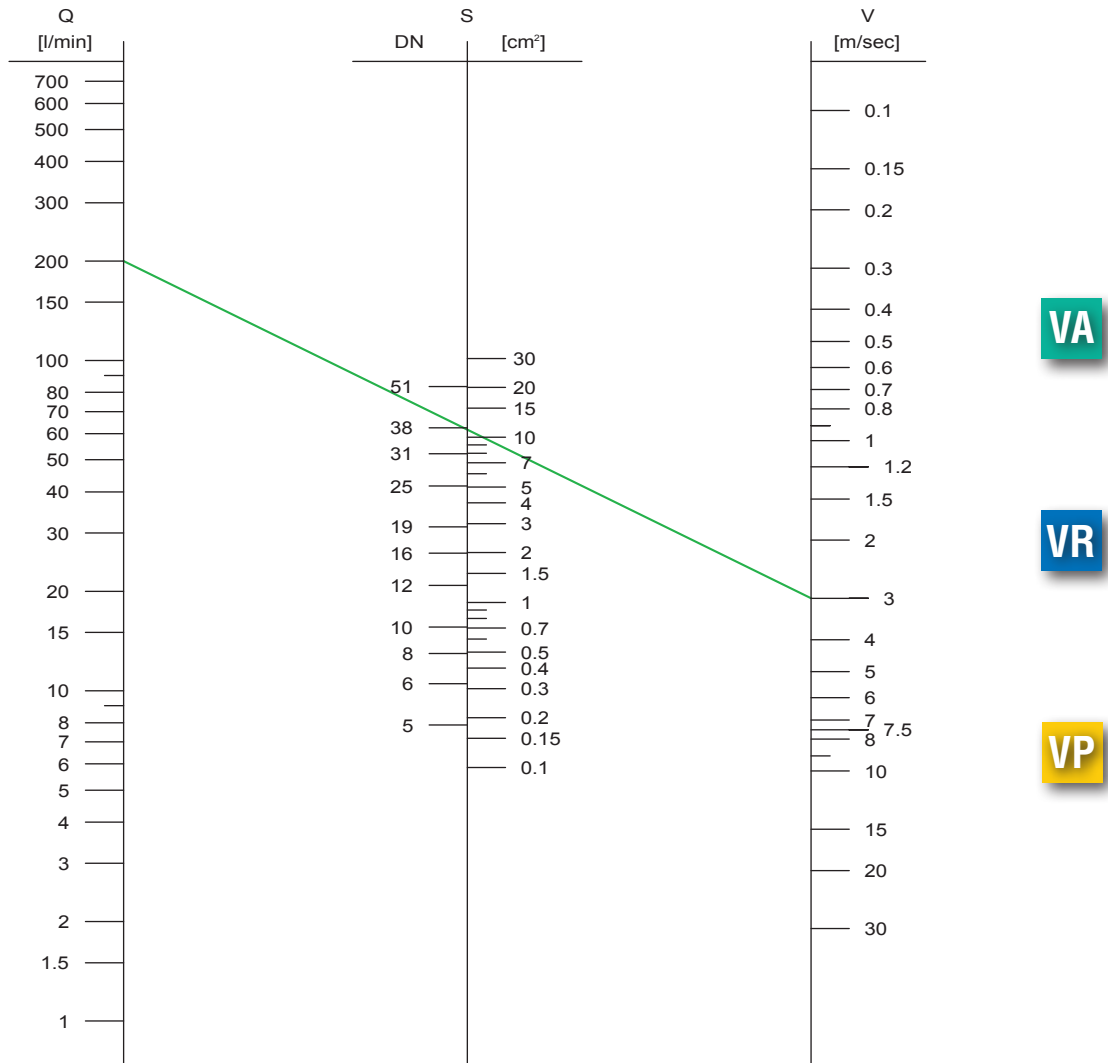

E.g.:

For a fluid flow $Q=200$ l/min and fluid speed $V=3$ m/s, a size of DN38 is obtained.

Legenda

Q = flexible hose flow in l/min

S = cross section of the flexible tube in cm²
(DN is the corresponding diameter)

V = fluid speed

VP = maximum speed suggested for pressured systems







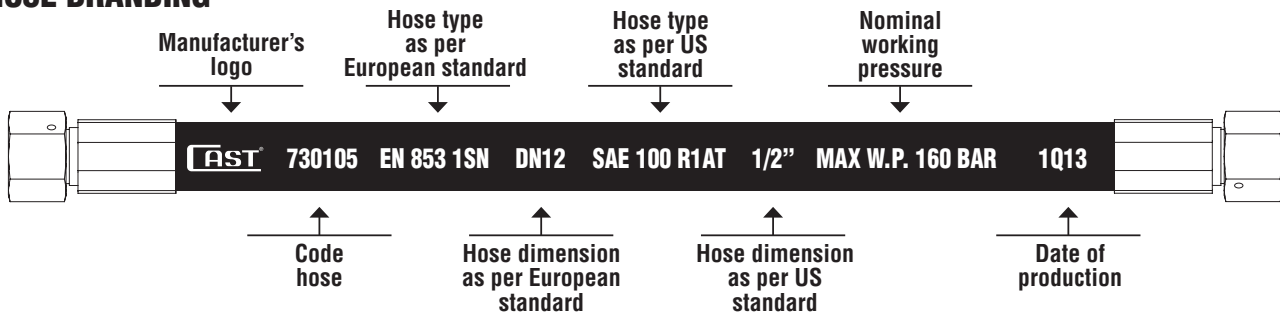



VA = maximum speed suggested for intake systems

VR = maximum speed suggested for return systems

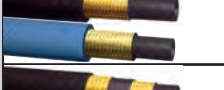
HOSE BRANDING









WORKING PRESSURES FOR FLEXIBLE TUBES

HOSE TYPE	HOSE DIMENSION											
	5	6	8	10	12	16	19	25	31	38	51	DN
	-3	-4	-5	-6	-8	-10	-12	-16	-20	-24	-32	SIZE
	3/16	1/4	5/16	3/8	1/2	5/8	3/4	1	1 1/4	1 1/2	2	INCH
 7301.. EN 853 1SN SAE 100 R1AT	250	225	215	180	160	130	105	88	63	50	40	bar
	3625	3263	3118	2610	2320	1885	1523	1276	914	725	580	psi
 7302.. EN 853 2SN SAE 100 R2AT	415	400	350	330	275	250	215	165	125	90	80	bar
	6018	5800	5075	4785	3988	3625	3118	2393	1813	1305	1131	psi
 7305.. EN 857 1SC	-	225	215	180	160	-	-	-	-	-	-	bar
	-	3263	3118	2610	2320	-	-	-	-	-	-	psi
 7306.. EN 857 2SC SAE 100 R16	-	400	350	330	275	250	215	165	-	-	-	bar
	-	5800	5075	4785	3988	3625	3118	2393	-	-	-	ps
 7314..-7315.. 1SC HYDRO-WASH	-	250	250	250	-	-	-	-	-	-	-	bar
	-	3625	3625	3625	-	-	-	-	-	-	-	psi
 7316..-7317.. 2SC HYDRO-WASH	-	400	400	400	-	-	-	-	-	-	-	bar
	-	5800	5800	5800	-	-	-	-	-	-	-	psi
 7308.. EN 856 4SP	-	450	-	445	415	350	350	280	-	-	-	bar
	-	6525	-	6453	6018	5075	5075	4060	-	-	-	psi
 7309.. EN 856 4SH	-	-	-	-	-	-	420	380	325	290	250	bar
	-	-	-	-	-	-	6090	5510	4713	4205	3625	psi
 7310.. EN 856 R13	-	-	-	-	-	-	345	345	345	345	345	bar
	-	-	-	-	-	-	5000	5000	5000	5000	5000	psi
 7311.. EN 855 R7 SAE 100 R7	210	200	190	175	-	-	-	-	-	-	-	bar
	3045	2900	2755	2537	-	-	-	-	-	-	-	psi
 7312.. R7TM	325	300	240	225	190	150	130	105	-	-	-	bar
	4710	4350	3480	3260	2755	2175	1885	1522	-	-	-	psi

Notes: The outer diameters of the hoses stated are approximate. These diameters may vary based on the construction tolerances in accordance with the limits set by regulations.

For applications with compressed air is the maximum pressure of 50 bar and the maximum temperature is 80°

SYMBOL	DESCRIPTION	SYMBOL	DESCRIPTION
	Inner diameter of the flexible hose DN= identification of the inner diameter of the hose according to the construction rules of the flexible tubes (EN) mm= nominal inner diameter of the hose in mm according to the construction rules of the flexible tubes (EN/SAE) SIZE= identification of the inner diameter of the hose according to SAE J517 (value expressed in 1/16 of an inch) INCH= nominal inner diameter of the hose in inches		Minimum bending radius
			Maximum working pressure
			Burst pressure
			Hose unitary linear weight
			Outer diameter of the flexible hose

HOSE EN 853 1SN - SAE 100 R1AT

Application Medium pressure hydraulic systems with mineral and vegetable oils, water, aqueous solutions, air*, inert gases*.







Manufacture:
- **Internal tube** Substrate of synthetic oil resistant rubber.

- **Reinforcement** 1 braid of high resistance steel.

- **Covering** Black synthetic rubber resistant to abrasion, oils, fuels, ozone, atmospheric agents.
* With gas pressures higher than 15 bars, the covering needs perforation.

Working temperature from -40°C to +100°C, differences up to +120°C are tolerated.



CODE											
	Ø internal				Ø external	R min.	PN		P burst		Weight g/m
	DN	mm	size	inch			bar	psi	bar	psi	
730101	5	4,8	-3	3/16	11,6	90	250	3625	1000	14500	180
730102	6	6,6	-4	1/4	13	100	225	3263	900	13050	190
730103	8	8,3	-5	5/16	14,7	115	215	3118	850	12325	220
730104	10	9,9	-6	3/8	16,8	125	180	2610	720	10440	280
730105	12	13	-8	1/2	20	180	160	2320	640	9280	360
730106	16	16,4	-10	5/8	23,2	200	130	1885	520	7540	440
730107	19	19,5	-12	3/4	27,1	240	105	1523	420	6090	560
730108	25	26	-16	1	35,1	300	88	1276	350	5075	830
730109	31	32,5	-20	1 1/4	42,5	420	63	914	250	3625	1070
730110	38	38,7	-24	1 1/2	50,1	500	50	725	200	2900	1420
730111	51	51,1	-32	2	64,1	630	40	580	160	2320	2010

HOSE EN 853 2SN - SAE 100 R2AT

Application Medium pressure hydraulic systems with mineral and vegetable oils, water, aqueous solutions, air*, inert gases*.







Manufacture:
- **Internal tube** Substrate of synthetic oil resistant rubber.

- **Reinforcement** 2 braids of high resistance steel.

- **Covering** Black synthetic rubber resistant to abrasion, oils, fuels, ozone, atmospheric agents.
* With gas pressures higher than 15 bars, the covering needs perforation.

Working temperature from -40°C to +100°C, differences up to +120°C are tolerated.



CODE											
	Ø internal				Ø external	R min.	PN		P burst		Weight g/m
	DN	mm	size	inch			bar	psi	bar	psi	
730201	5	4,8	-3	3/16	13,3	90	415	6018	1650	23925	300
730202	6	6,6	-4	1/4	14,4	100	400	5800	1600	23200	310
730203	8	8,3	-5	5/16	16	115	350	5075	1400	20300	370
730204	10	9,9	-6	3/8	18,4	125	330	4785	1320	19140	440
730205	12	13	-8	1/2	21,4	180	275	3988	1100	15950	530
730206	16	16,4	-10	5/8	24,6	200	250	3625	1000	14500	660
730207	19	19,5	-12	3/4	28,6	240	215	3118	850	12325	840
730208	25	26	-16	1	37,1	300	165	2393	650	9425	1230
730209	31	32,5	-20	1 1/4	46,7	420	125	1813	500	7250	1770
730210	38	38,7	-24	1 1/2	54,5	500	90	1305	360	5220	2170
730211	51	51,1	-32	2	66,7	630	80	1131	310	4500	2790

HOSE EN 857 1SC

Application Medium pressure hydraulic systems with mineral and vegetable oils, water, aqueous solutions, air*, inert gases*.







Manufacture:
- **Internal tube** Substrate of synthetic oil resistant rubber.

- **Reinforcement** 1 braid of high resistance steel.

- **Covering** Black synthetic rubber resistant to abrasion, oils, fuels, ozone, atmospheric agents.
* With gas pressures higher than 15 bars, the covering needs perforation.

Working temperature from -40°C to +100°C, differences up to +120°C are tolerated.



CODE											
	Ø internal				Ø external	R min.	PN		P burst		Weight g/m
	DN	mm	size	inch			bar	psi	bar	psi	
730502	6	6,6	-4	1/4	11,9	75	225	3263	900	13050	160
730503	8	8,3	-5	5/16	13,7	85	215	3118	850	12325	210
730504	10	9,9	-6	3/8	15,7	90	180	2610	720	10440	260
730505	12	13	-8	1/2	19,5	130	160	2320	640	9280	340

HOSE EN 857 2SC

Application Medium pressure hydraulic systems with mineral and vegetable oils, water, aqueous solutions, air*, inert gases*.







Manufacture:
- **Internal tube** Substrate of synthetic oil resistant rubber.

- **Reinforcement** 2 braids of high resistance steel.

- **Covering** Black synthetic rubber resistant to abrasion, oils, fuels, ozone, atmospheric agents.
* With gas pressures higher than 15 bars, the covering needs perforation.

Working temperature from -40°C to +100°C, differences up to +120°C are tolerated.



CODE											
	Ø internal				Ø external	R min.	PN		P burst		Weight g/m
	DN	mm	size	inch			bar	psi	bar	psi	
730602	6	6,6	-4	1/4	13	75	400	5800	1600	23200	250
730603	8	8,3	-5	5/16	14,6	85	350	5075	1400	20300	300
730604	10	9,9	-6	3/8	16,6	90	330	4785	1320	19140	370
730605	12	13	-8	1/2	20	130	275	3988	1100	15950	450
730606	16	16,4	-10	5/8	23,9	170	250	3625	1000	14500	610
730607	19	19,5	-12	3/4	27,6	200	215	3118	850	12350	760
730608	25	26	-16	1	35,6	250	165	2393	650	9425	1150

HOSE 1SC HIGH PRESSURE WATER JET WASHER







Application For cleaning with high pressure hot water.

Manufacture:

- **Internal tube** Special synthetic rubber resistant to 150°C, hot water, detergents.
- **Reinforcement** 1 braid of high resistance steel.
- **Covering** Special black synthetic rubber with cloth impression, microperforated, resistant to oils, abrasion and atmospheric agents.

Working temperature from -40°C to +150°C



CODE											
	Ø internal				Ø external	R min.	PN		P burst		Weight g/m
	DN	mm	size	inch			bar	psi	bar	psi	
731402	6	6,6	-4	1/4	11,8	75	250	3625	1000	14500	160
731403	8	8,3	-5	5/16	13,7	85	250	3625	1000	14500	210
731404	10	9,9	-6	3/8	15,5	90	250	3625	1000	14500	290

HOSE 1SC HIGH PRESSURE WATER JET WASHER





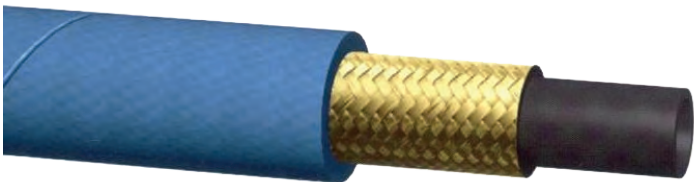

Application For cleaning with high pressure hot water.

Manufacture:

- **Internal tube** Special synthetic rubber resistant to 150°C, hot water, detergents.
- **Reinforcement** 1 braid of high resistance steel.
- **Covering** Special black synthetic rubber with cloth impression, microperforated, resistant to oils, abrasion and atmospheric agents.

Working temperature from -40°C to +150°C



CODE											
	Ø internal				Ø esterno	R min.	PN		P burst		Weight g/m
	DN	mm	size	inch			bar	psi	bar	psi	
731502	6	6,6	-4	1/4	11,8	75	250	3625	1000	14500	160
731503	8	8,3	-5	5/16	13,7	85	250	3625	1000	14500	210
731504	10	9,9	-6	3/8	15,5	90	250	3625	1000	14500	290

HOSE 2SC HIGH PRESSURE WATER JET WASHER







Application For cleaning with high pressure hot water.

Manufacture:

- **Internal tube** Special synthetic rubber resistant to 150°C, hot water, detergents.
- **Reinforcement** 2 braids of high resistance steel.
- **Covering** Special black synthetic rubber with cloth impression, microperforated, resistant to oils, abrasion and atmospheric agents.

Working temperature from -40°C to +150°C



CODE											
	Ø internal				Ø external	R min.	PN		P burst		Weight g/m
	DN	mm	size	inch			bar	psi	bar	psi	
731602	6	6,6	-4	1/4	13	75	400	5800	1600	23200	250
731603	8	8,3	-5	5/16	14,6	85	400	5800	1600	23200	300
731604	10	9,9	-6	3/8	16,6	90	400	5800	1600	23200	370

HOSE 2SC HIGH PRESSURE WATER JET WASHER

Application For cleaning with high pressure hot water.







Manufacture:
- **Internal tube** Special synthetic rubber resistant to 150°C, hot water, detergents.

- **Reinforcement** 2 braids of high resistance steel.

- **Covering** Special black synthetic rubber with cloth impression, microperforated, resistant to oils, abrasion and atmospheric agents.

Working temperature from -40°C to +150°C



CODE											
	Ø internal				Ø external	R min.	PN		P burst		Weight g/m
	DN	mm	size	inch			bar	psi	bar	psi	
731702	6	6,6	-4	1/4	13	75	400	5800	1600	23200	250
731703	8	8,3	-5	5/16	14,6	85	400	5800	1600	23200	300
731704	10	9,9	-6	3/8	16,6	90	400	5800	1600	23200	370

HOSE EN 856 4SP

Application Very high pressure hydraulic systems, also pulsating, with oils, water, aqueous solutions, air*, inert gases*.







Manufacture:
- **Internal tube** Substrate of synthetic oil resistant rubber.

- **Reinforcement** 4 spirals of high resistance steel.

- **Covering** Black synthetic rubber resistant to abrasion, oils, fuels, ozone, atmospheric agents.
* With gas pressures higher than 15 bars, the covering needs perforation.

Working temperature from -40°C to +100°C, with discontinuous operation +120°C max.



CODE											
	Ø internal				Ø external	R min.	PN		P burst		Weight g/m
	DN	mm	size	inch			bar	psi	bar	psi	
730802	6	6,6	-4	1/4	17,6	150	450	6525	1800	26100	585
730804	10	9,9	-6	3/8	21,1	180	445	6453	1780	25810	700
730805	12	13	-8	1/2	24,2	230	415	6018	1660	24070	850
730806	16	16,4	-10	5/8	27,9	250	350	5075	1400	20300	1040
730807	19	19,5	-12	3/4	32	300	350	5075	1400	20300	1320
730808	25	26	-16	1	38,9	340	280	4060	1120	16240	2060

HOSE EN 856 4SH

Application Very high pressure hydraulic systems, also pulsating, with oils, water, aqueous solutions, air*, inert gases*.







Manufacture:
- **Internal tube** Substrate of synthetic oil resistant rubber.

- **Reinforcement** 4 spirals of high resistance steel.

- **Covering** Black synthetic rubber resistant to abrasion, oils, fuels, ozone, atmospheric agents.
* With gas pressures higher than 15 bars, the covering needs perforation.

Working temperature from -40°C to +100°C, with discontinuous operation +120°C max.



CODE													
	Ø internal						Ø external	R min.	PN			P burst	
	DN	mm	size	inch					bar	psi		bar	psi
730907	19	19,5	-12	3/4	31,9	280	420	6090	1680	24360	1430		
730908	25	26	-16	1	38,7	340	380	5510	1520	22040	2200		
730909	31	32,5	-20	1 1/4	45,2	460	325	4713	1300	18850	2580		
730910	38	38,7	-24	1 1/2	53,4	560	290	4205	1160	16820	3300		
730911	51	51,1	-32	2	67,3	700	250	3625	1000	14500	4940		

HOSE EN 856 R13

Application Very high pressure hydraulic systems, also pulsating, with oils, water, aqueous solutions, air*, inert gases*.







Manufacture:
- **Internal tube** Substrate of synthetic oil resistant rubber.

- **Reinforcement** 4 - 6 spirals of high resistance steel.

- **Covering** Black synthetic rubber resistant to abrasion, oils, fuels, ozone, atmospheric agents.
* With gas pressures higher than 15 bars, the covering needs perforation.

Working temperature from -40°C to +120°C.



CODE													
	Ø internal						Ø external	R min.	PN			P burst	
	DN	mm	size	inch					bar	psi		bar	psi
731007	19	19,5	-12	3/4	32,3	240	345	5000	1380	20000	1570		
731008	25	26	-16	1	38,7	300	345	5000	1380	20000	1920		
731009	31	32,5	-20	1 1/4	49,8	420	345	5000	1380	20000	3600		
731010	38	38,7	-24	1 1/2	57,3	500	345	5000	1380	20000	4800		
731011	51	51,1	-32	2	71,1	630	345	5000	1380	20000	6600		

HOSE ISO 3949 R7 EN 855 - SAE 100 R7

Application Medium pressure hydraulic systems with mineral and vegetable oils, water, aqueous solutions, air*, inert gases*.

Manufacture:

- **Internal tube** Oil resistant thermoplastic polymer.





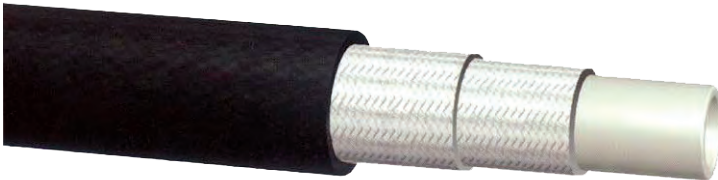

- **Reinforcement** 2 braids of high resistance polyester.

- **Covering** abrasion resistant thermoplastic polyurethane.

Working

temperature from -40°C to +100°C.



CODE													
	Ø internal						Ø external	R min.	PN			P burst	
	DN	mm	size	inch					bar	psi		bar	psi
731101	5	4,8	-3	3/16	10	30	210	3045	840	12180	73		
731102	6	6,4	-4	1/4	11,8	35	200	2900	800	11600	90		
731103	8	8	-5	5/16	14,3	45	190	2755	760	11020	128		
731104	10	9,7	-6	3/8	16	55	175	2537	700	10150	155		

HOSE R7TM

Application Medium pressure hydraulic systems with mineral and vegetable oils, water, aqueous solutions, air*, inert gases*.

Manufacture:

- **Internal tube** Oil resistant thermoplastic polymer.





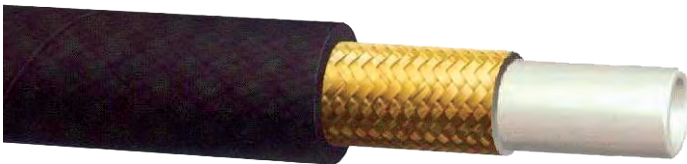

- **Reinforcement** 1 braid of high resistance steel.

- **Covering** abrasion resistant thermoplastic polyurethane.

Working

temperature from -40°C to +100°C.



CODE													
	Ø internal						Ø external	R min.	PN			P burst	
	DN	mm	size	inch					bar	psi		bar	psi
731201	5	4,7	-3	3/16	10	30	325	4710	1300	18850	120		
731202	6	6,3	-4	1/4	11,9	40	300	4350	1200	17400	170		
731203	8	8,2	-5	5/16	14	50	240	3480	960	13920	221		
731204	10	9,7	-6	3/8	16	60	225	3260	900	13050	260		
731205	12	12,8	-8	1/2	19,2	75	190	2755	760	11020	326		
731206	16	16	-10	5/8	23,3	110	150	2175	600	8700	412		
731207	19	19,4	-12	3/4	25,5	150	130	1885	520	7540	454		
731208	25	25	-16	1	32,5	185	105	1522	420	6090	590		

ASSEMBLY INSTRUCTIONS FOR FLEXIBLE HOSE FITTINGS

FITTINGS FOR FLEXIBLE HOSES WITHOUT EXTERNAL PEELING - STANDARD SERIES

1. Cut the hose at the desired length at a right angle with the specific disc cutter. Remove any cutting residues from the hose edge (Fig.1).
2. Insert the sleeve on the hose until it stops (Fig.3).
3. Insert the stud of the fitting into the hose until the same fitting comes into contact with the sleeve (Fig.4).
4. Press the sleeve on the hose with the suitable clamps following the directions in the pressing tables (Fig.5).
5. It is imperative to check the collapse of the fitting hole with the appropriate tools. The assembled hoses that are not within the set tolerance can not be used.

FITTINGS FOR FLEXIBLE HOSES WITH EXTERNAL PEELING - STANDARD SERIES

1. Cut the tube at the desired length at a right angle with the specific disc cutter. Remove any cutting residues from the hose edge (Fig.1).
2. Remove the external cover of the hose for the length indicated in the tables for the assembly to the outer diameter of the metal reinforcement, avoiding damaging it (Fig.2).
3. Insert the sleeve on the hose until it stops so to entirely cover the portion of the hose that has no external cover (Fig.3).
4. Insert the hose holder stem of the fitting into the tube until the same fitting comes into contact with the sleeve (Fig.4).
5. Press the sleeve on the hose with the suitable clamps following the directions in the pressing tables (Fig.5).
6. It is imperative to check the collapse of the fitting hole with the appropriate tools. The assembled hoses that are not within the set tolerance can not be used.

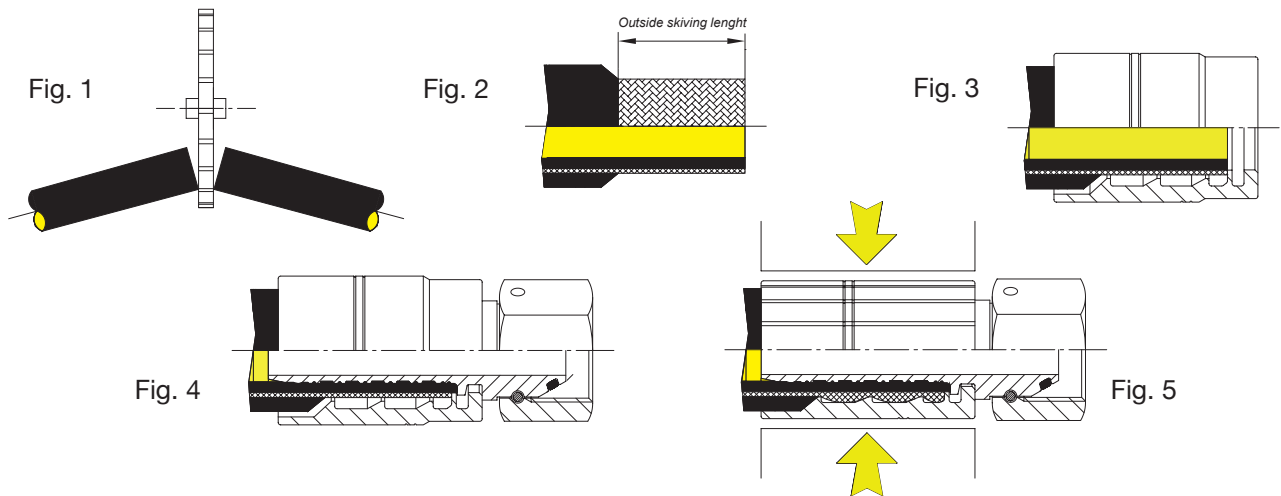

FITTINGS FOR FLEXIBLE HOSES WITH EXTERNAL AND INTERNAL PEELING - SERIES INTERLOCK

1. Cut the hose at the desired length at a right angle with the specific disc cutter. Remove any cutting residues from the hose edge (Fig.6).
2. Remove the external cover of the hose for the length indicated in the tables for the assembly to the outer diameter of the metal reinforcement, avoiding damaging it (Fig.7).
3. Remove the internal substrate of the hose for the length indicated in the tables for the assembly to the inner diameter of the metal reinforcement, avoiding damaging it and eliminating any machining residue (Fig.8).
4. Insert the sleeve on the hose until it stops so to entirely cover the portion of the hose that has no external cover (Fig.9).
5. Insert the hose holder stem of the fitting into the tube until the same fitting comes into contact with the sleeve (Fig.10).
6. Press the sleeve on the hose with the suitable clamps following the directions in the pressing tables (Fig.11).
7. It is imperative to check the collapse of the fitting hole with the appropriate tools. The assembled hoses that are not within the set tolerance can not be used and must remade.

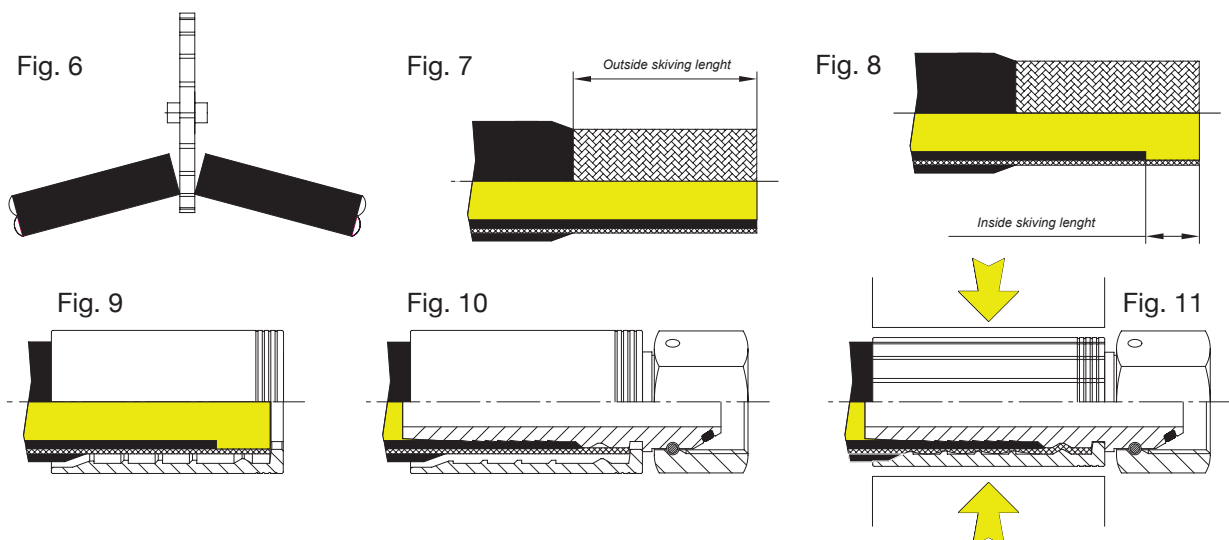

TIGHTENING TORQUES

24° CONE FITTINGS ISO 8434-1 (DIN 2353)

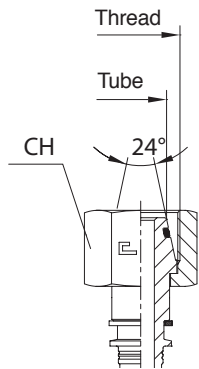

Light series "L"				Heavy series "S"			
METRIC PARAL. THREAD	Ø TUBE	KEY (CH)	TORQUE ^{+10%} ₀ [Nm]	METRIC PARAL. THREAD	Ø TUBE	KEY (CH)	TORQUE ^{+10%} ₀ [Nm]
M12x1.5	6	14	20	M14x1.5	6	17	38
M14x1.5	8	17	38	M16x1.5	8	19	45
M16x1.5	10	19	45	M18x1.5	10	22	51
M18x1.5	12	22	51	M20x1.5	12	24	58
M22x1.5	15	27	74	M22x1.5	14	27	74
M26x1.5	18	32	105	M24x1.5	16	30	74
M30x2	22	36	135	M30x2	20	36	135
M36x2	28	41	166	M36x2	25	41	166
M45x2	35	50	290	M42x2	30	50	240
M52x2	42	60	330	M52x2	38	60	330

INNER FLANGE - ISO 6162-1/-2, SAE J518

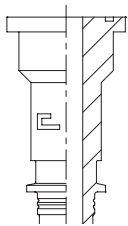

Series 3000					Series 6000				
Ø FLANGE	Metric thread screw		UNC thread screw		Ø FLANGIA	Metric thread screw		UNC thread screw	
	THREAD	TORQUE [Nm]	THREAD	TORQUE ^{+10%} ₀ [Nm]		THREAD	TORQUE [Nm]	THREAD	TORQUE ^{+10%} ₀ [Nm]
1/2	M8	24	5/16-18	24	1/2	M8	20	5/16-18	24
3/4	M10	50	3/8-16	43	3/4	M10	50	3/8-16	43
1"	M10	50	3/8-16	43	1"	M12	92	7/16-14	70
1.1/4	M10	50	7/16-14	70	1.1/4	M12	92	1/2-13	105
1.1/2	M12	92	1/2-13	105	1.1/2	M16	210	5/8-11	210
2"	M12	92	1/2-13	105	2"	M20	400	3/4-10	360

ORFS FITTINGS - ISO 8434-3 (SAE J1453)

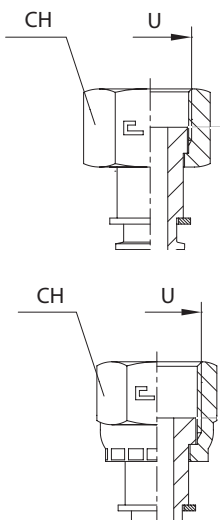

THREAD UNF/UNS/UN-2A	KEY (CH)	SLIP-ON NUT	STAPLED NUT
		TORQUE ^{+10%} ₀ [Nm]	TORQUE ^{+10%} ₀ [Nm]
9/16-18	17	25	25
11/16-16	22	40	40
13/16-16	24	55	55
1-14	30	60	60
1.3/16-12	36	90	90
1.7/16-12	41	125	125
1.11/16-12	50	170	170
2-12	60	200	200

Notes: All the values reported in the above tightening tables are mere indication, and come from a series of practical tests carried out in the technical laboratory of CASALGRASSO (CN). These may vary according to the materials and to the tolerances of the employed components.

TIGHTENING TORQUES

JIC 74° FITTINGS - ISO 8434-2 (SAE J514)

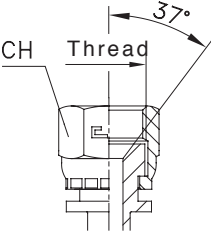
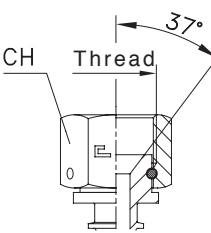
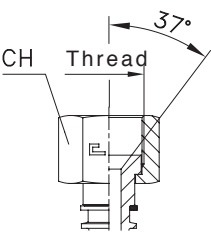
		STAPLED NUT	SWIVEL NUT	SLIP-ON NUT
				
THREAD UNF/UN	KEY (CH)	TORQUE ^{+10%} ₀ [Nm]	TORQUE ^{+10%} ₀ [Nm]	TORQUE ^{+10%} ₀ [Nm]
7/16-20	14	15	20	20
1/2-20	17	20	25	25
9/16-18	19	30	35	35
3/4-16	24	50	60	60
7/8-14	27	69	85	85
1.1/16-12	32	98	140	140
1.3/16-12	36	118	-	-
1.5/16-12	41	140	230	230
1.5/8-12	50	-	380	380
1.7/8-12	60	-	460	460

60° CONE FITTINGS ISO 8434-6 (BS 5200)

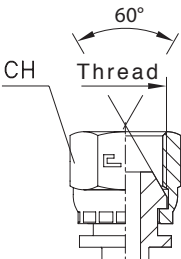
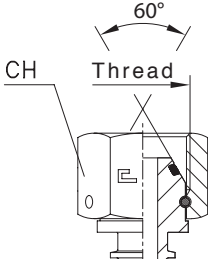
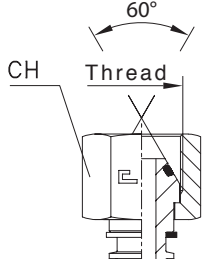
		STAPLED NUT	SWIVEL NUT	SLIP-ON NUT
				
BSPB THREAD	KEY (CH)	TORQUE ^{+10%} ₀ [Nm]	TORQUE ^{+10%} ₀ [Nm]	COPIA ^{+10%} ₀ [Nm]
G 1/8	14	15	25	20
G 1/4	19	20	65	30
G 3/8	22	34	85	75
G 1/2	27	60	150	130
G 5/8	30	69	200	170
G 3/4	32	115	260	220
G 1"	41	140	320	270
G 1.1/4	50	-	500	420
G 1.1/2	55	-	600	510
G 2"	70	-	700	600
M 12x1,5	17	15	35	30
M 14x1,5	19	20	45	38
M 16x1,5	22	35	55	48
M 18x1,5	24	48	70	60
M 20x1,5	27	60	80	70
M 22x1,5	27	60	100	85
M 26x1,5	32	115	170	150
M 30x1,5	36	130	250	210
M 38x1,5	46	200	310	280
M 45x1,5	55	290	380	320

Notes: All the values reported in the above tightening tables are mere indication, and come from a series of practical tests carried out in the technical laboratory of CASALGRASSO (CN). These may vary according to the materials and to the tolerances of the employed components.

PRESCRIPTIONS FOR THE INSTALLATION OF FLEXIBLE HOSES ACCORDING TO DIN 20066

To ensure the efficiency, safety and duration of the flexible hoses and related fittings it is necessary not to exceed the admitted working pressures and maximum temperatures, assemble the hoses correctly, use the most suitable fittings based on the assembly conditions, determine the length of the hoses in consideration of their movement, if any.

Therefore, the correct installation of the assembled flexible hoses requires the compliance with the prescriptions described below.

1. Do not apply torques to the flexible hoses along its axis as this could cause a drop in pressure (Fig.1).

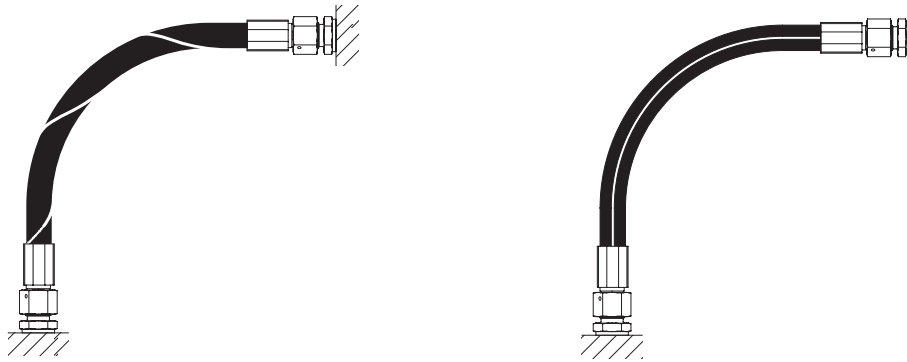

Fig. 1

Incorrect assembly

Correct assembly

2. The flexible hose must be assembled so that in normal working conditions it does not undergo any tensile stress other than that due to its own weight, and any compression stress to avoid breaking (Fig.2).

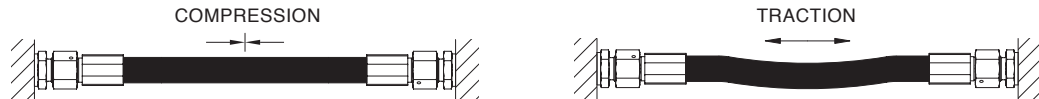

Fig. 2

Incorrect assembly

Correct assembly

3. The flexible hose must be assembled by following the natural curvature as much as possible and maintaining the minimum bending radius allowed to prevent any constriction and collapse and not to shorten the life of the assembly. If this prescription can not be followed please use elbow fittings (Fig.3).

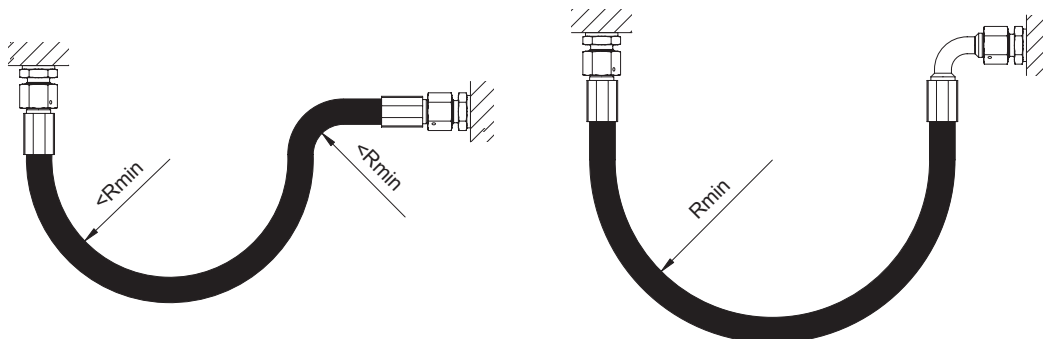

Fig. 3

Incorrect assembly

Correct assembly

PRESCRIPTIONS FOR THE INSTALLATION OF FLEXIBLE HOSES ACCORDING TO DIN 20066

4. If the flexible hose must be bent, its length must be such to maintain the minimum bending radius allowed and start the curve only after a length equal to $1.5d$. If this prescription can not be complied with, arrange for a protection in the folding area (Fig.4).

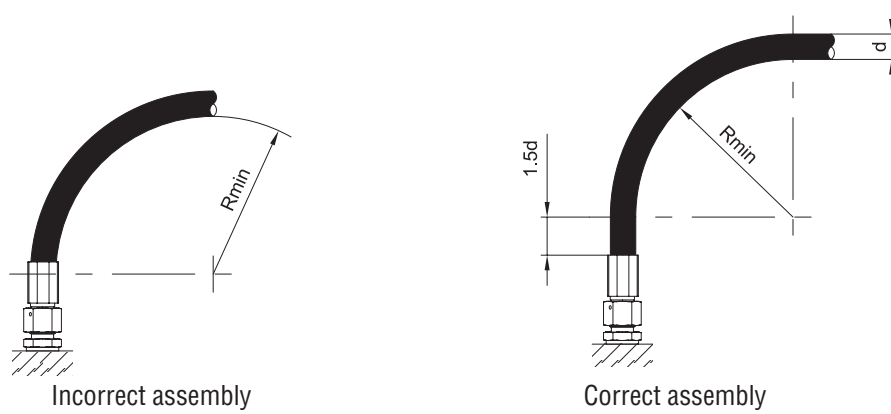

5. Use suitable fittings to avoid any undesired additional stress to the flexible hose (Fig.5).

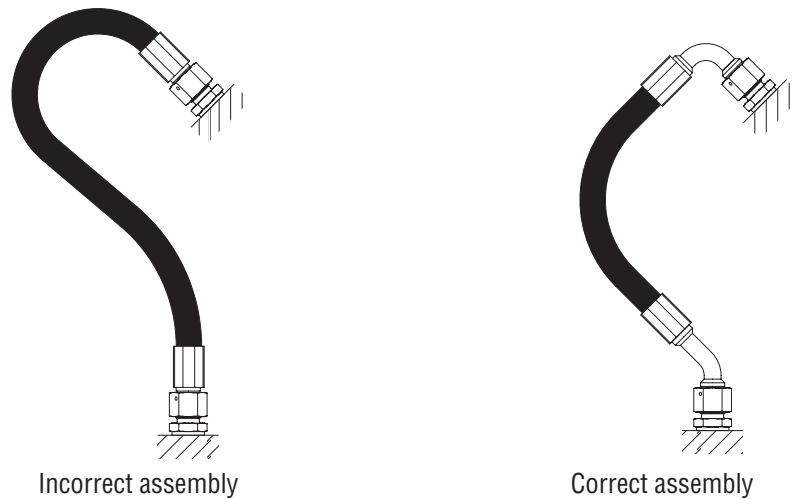

6. To prevent any damage to the flexible hose caused by external factors, it is necessary to eliminate any undesired mechanical action and prevent the flexible hose from rubbing against the components of the bearing structure or the other hoses. Select a suitable assembly position for the flexible hoses and adequate fixing. Protect the flexible hose with sheaths or similar protections, if necessary. The parts with sharp edges must be covered or eliminated (Fig.6).

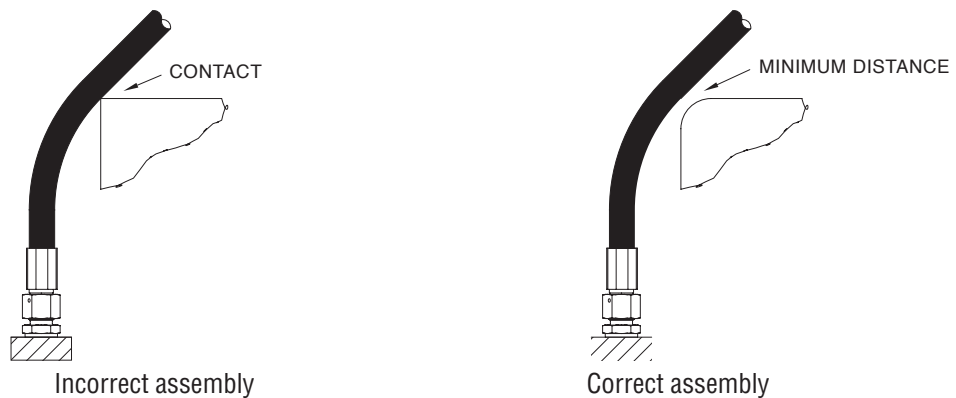

PRESCRIPTIONS FOR THE INSTALLATION OF FLEXIBLE HOSES ACCORDING TO DIN 20066

7. For applications with moving parts, the length of the flexible hose must be calculated in a way that, within the range of motion, the minimum bending radius allowed is maintained and the hose does not undergo any tensile stress (Fig.7).

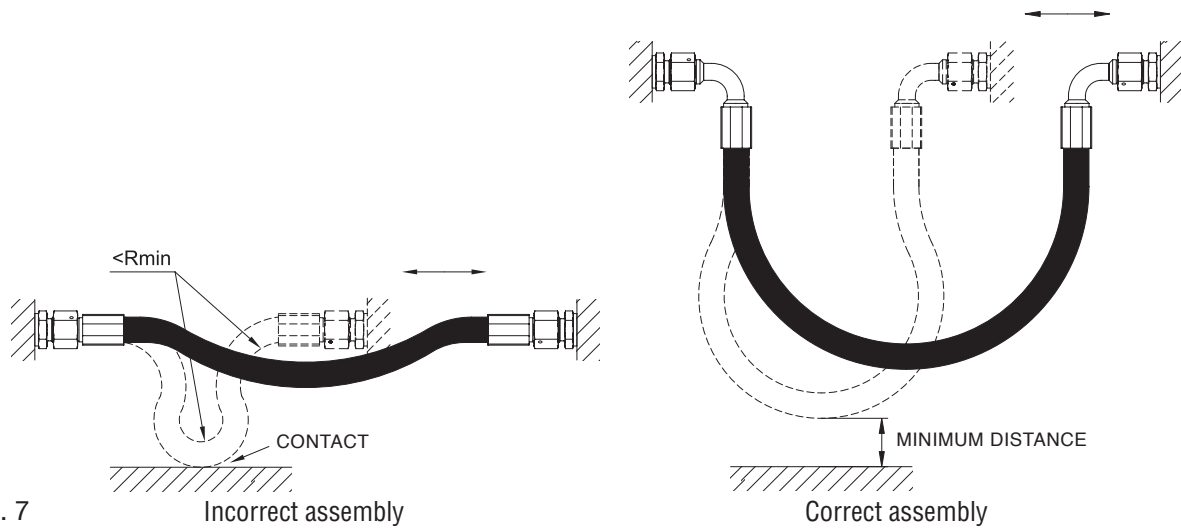

Fig. 7

Incorrect assembly

Correct assembly

8. For applications with moving parts it is necessary to avoid the torque of the flexible hose when the longitudinal movement and the curvature take place in the same plain. This condition can be obtained through correct assembly, with suitable constructive measurements and by using adequate fittings (Fig. 8).

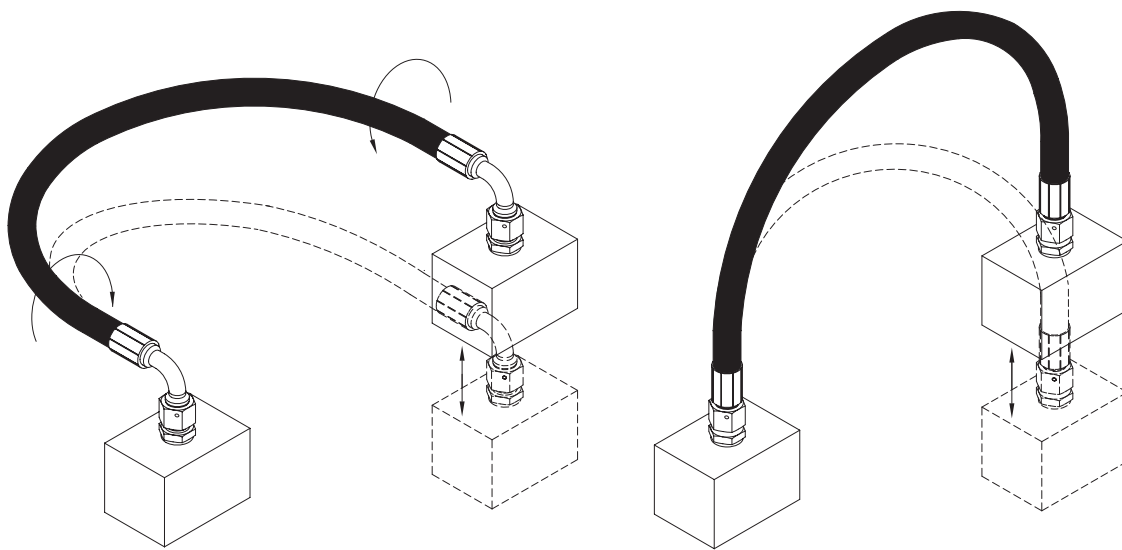

Fig. 8

Incorrect assembly

Correct assembly

LENGTH AND ORIENTATION OF THE ASSEMBLED FLEXIBLE HOSES

The length of a flexible hose assembled with straight male fittings must be measured at the ends of the two connections. For female fittings the length is measured at the end of the conical seals or on the flat seal surfaces. In case of elbow fittings and eyelet fittings the length is measured on the interaxes while also considering the criteria described for straight fittings (Fig.1). To determine the right length of an assembled hose it is advisable to consider the possible lengthening or shortening under pressure according to the construction rules for the individual hoses (from -2% to +4% for hoses type 1SN, 2SN, 2SC, 4SP, 4SH; $\pm 3\%$ for hose type R7).

When a flexible tube is assembled with one or both the elbow or eyelet fittings, their orientation needs to be indemnified for correct assembly. Keeping the tube in horizontal position, the angle related to the fittings is determined starting from the fitting that is the closest to the eye of the observer in vertical position, downwards, and by rotating the furthest fitting anti clockwise (Fig.2).

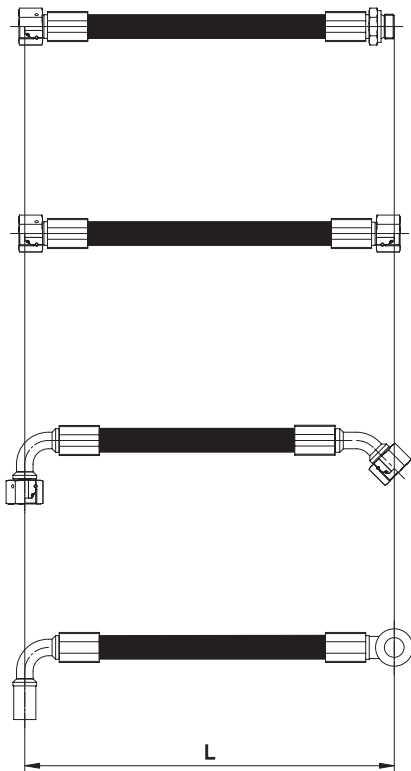

Fig. 1

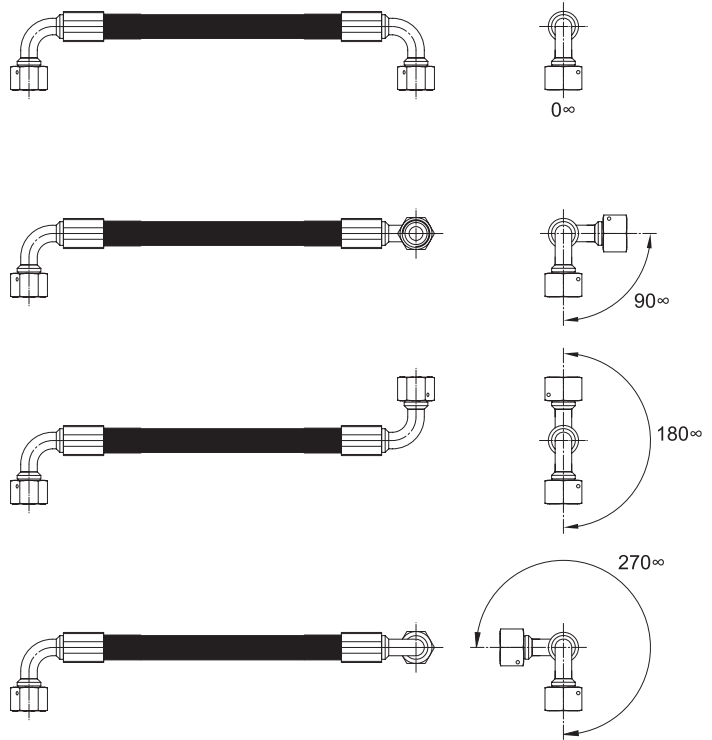

Fig. 2

Tolerances on the lengths and orientation of the flexible hoses assembled according to DIN 20066

HOSE LENGTH L	Ø INTERNAL HOSE		TORQUE B
	FROM DN 5 TO DN 25	FROM DN 5 TO DN 25	
Up to 630mm	da -3 a +7mm	da -4 a +12mm	±5°
Beyond 630 mm up to 1250 mm	da -4 a +12mm	da -6 a +20mm	
Beyond 1250 mm up to 2500 mm	da -6 a +20mm	da -6 a +25mm	
Beyond 2500 mm up to 8000 mm	da -0,5% a +1,5%		
Beyond 8000 mm	da -1% a +3%		

FERRULE FOR HOSE 1SN-R1AT - 2SC SKIVE

Code: 8001..
Type: BP1

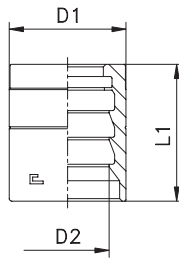

CODE	I.D. hose		Dimensions [mm]			Skiving lenght
	INCH	DN	D1	D2	L1	
800101	3/16	5	16	9,9	23,5	16
800102	1/4	6	19	12,7	25,5	18
800103	5/16	8	21	14	26,5	17,5
800104	3/8	10	23	16,3	27	18,5
800105	1/2	12	28	19,8	29	19,5
800106	5/8	16	31	23	32	22,5
800107	3/4	19	35	27,1	36	25
800108	1	25	42	34	44,5	32
800109	1 1/4	31	50	41,6	48	33,5
800110	1 1/2	38	56	47,9	55	39
800111	2	51	70	61,2	63	45,5

Notes: If you wish to order a fitting in stainless steel, please change the first two digit from 80.... to 81.... .

FERRULE FOR HOSE 2SN-R2AT SKIVE

Code: 8002..
Type: BP2

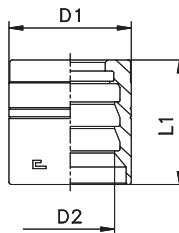

CODE	I.D. hose		Dimensions [mm]			Skiving lenght
	INCH	DN	D1	D2	L1	
800201	3/16	5	19	11,7	23,5	16
800202	1/4	6	20	13,7	25,5	18
800203	5/16	8	23	15,6	26,5	17,5
800204	3/8	10	24,5	17,8	27	18,5
800205	1/2	12	29	21,3	29	19,5
800206	5/8	16	33	24,3	32	22,5
800207	3/4	19	37	28,5	36	25
800208	1	25	45	35,8	44,5	32
800209	1 1/4	31	55	45,2	48	33,5
800210	1 1/2	38	61	51,5	55	39
800211	2	51	74	64,6	63	45,5

Notes: If you wish to order a fitting in stainless steel, please change the first two digit from 80.... to 81.... .

FERRULE FOR HOSE 1SN-R1AT - 2SC no skive

Code: **8003..**
 Type: **BPT1**

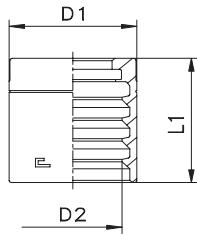

CODE	I.D. hose		Dimensions [mm]			Skiving lenght
	INCH	DN	D1	D2	L1	
800301	3/16	5	18	12,2	23,5	-
800302	1/4	6	19	13,9	25,5	-
800303	5/16	8	21	15,5	26,5	-
800304	3/8	10	23	17,7	27	-
800305	1/2	12	25	21,2	29	-
800306	5/8	16	31	24,4	32	-
800307	3/4	19	35	28,3	36	-
800308	1	25	43	36,5	44,5	-
800309	1 1/4	31	51	44,5	48	-
800310	1 1/2	38	58	51,2	55	-

Notes: If you wish to order a fitting in stainless steel, please change the first two digit from **80....** to **81....** .

FERRULE FOR HOSE 2SN-R2AT no skive

Code: **8004..**
 Type: **BPT2**

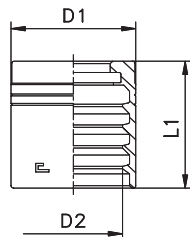

CODE	I.D. hose		Dimensions [mm]			Skiving lenght
	INCH	DN	D1	D2	L1	
800401	3/16	5	20	13,8	23,5	-
800402	1/4	6	21	15,5	25,5	-
800403	5/16	8	23	17	26,5	-
800404	3/8	10	25	19,4	27	-
800405	1/2	12	28	22,6	29	-
800406	5/8	16	32	25,9	32	-
800407	3/4	19	36	29,7	36	-
800408	1	25	45	38,3	44,5	-
800409	1 1/4	31	56	48,4	48	-
800410	1 1/2	38	64	55,3	55	-

Notes: If you wish to order a fitting in stainless steel, please change the first two digit from **80....** to **81....** .

FERRULE FOR HOSE 1SN-R1AT - 2SN-R2AT - 2SC NO SKIVE

Code: 8005..
Type: BPT12

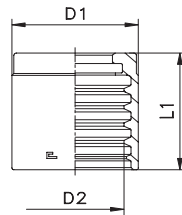

CODE	I.D. hose		Dimensions [mm]			Skiving lenght
	INCH	DN	D1	D2	L1	
800551	3/16	5	20,5	13,8	23,5	-
800552	1/4	6	22,5	15,5	25,5	-
800553	5/16	8	23,5	17	26,5	-
800554	3/8	10	25	19,4	27	-
800555	1/2	12	28	22,6	29	-
800556	5/8	16	32	25,9	32,5	-
800557	3/4	19	36	29,7	36	-
800558	1	25	45	38,3	44,5	-
800559	1 1/4	31	57	48,4	47	-
800560	1 1/2	38	65	55,3	58	-
800561	2	51	78	68,2	66,5	-

Notes: If you wish to order a fitting in stainless steel, please change the first two digit from 80.... to 81.... .

FERRULE FOR HOSE 1SC no skive

Code: 8005..-COMP
Type: BPT1

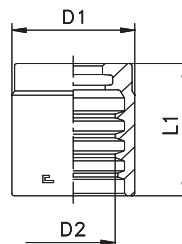

CODE	I.D. hose		Dimensions [mm]			Skiving lenght
	INCH	DN	D1	D2	L1	
800552-COMP	1/4	6	20	14,2	25	-
800553-COMP	5/16	8	22	16	26	-
800554-COMP	3/8	10	24	18,2	26	-
800555-COMP	1/2	12	27	21	28	-

Notes: If you wish to order a fitting in stainless steel, please change the first two digit from 80.... to 81.... .

FERRULE FOR HOSE 4SP - R9R - 4SH skive

Code: **8006..**
Type: **BPSP - BPSH**

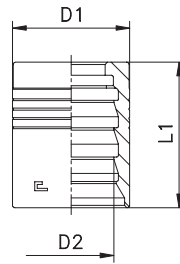

CODE	I.D. hose		Dimensions [mm]			Skiving lenght	Applicaztions
	INCH	DN	D1	D2	L1		
800602	1/4	6	22	15,4	30	23	4SP
800604	3/8	10	25	18,2	31	23,5	4SP
800605	1/2	12	29	21,6	35	26,5	4SP
800606	5/8	16	33	25	38	28,5	4SP
800607	3/4	19	38	29,2	43	32	4SP - 4SH*
800608	1	25	45	36,2	58	44,5	4SP - 4SH*
800609	1 1/4	31	52	43	64	49	4SH*
800610	1 1/2	38	60	50	72	56	4SH*
800611	2	51	75	64,3	81	63,5	4SH*

Notes: If you wish to order a fitting in stainless steel, please change the first two digit from **80....** to **81....** .
*The maximum permissible pressure is specified in the norm of the tube EN 856 4SP .

FERRULE FOR HOSE R7 - R7TM no skive

Code: **8008..**
Type: **BP78**

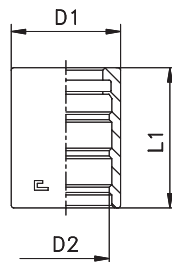

CODE	I.D. hose		Dimensions [mm]			Skiving lenght
	INCH	DN	D1	D2	L1	
800801	3/16	5	14	10,6	24	-
800802	1/4	6	17	13,4	25,5	-
800803	5/16	8	19	15,2	26,5	-
800804	3/8	10	21	16,7	27	-
800805	1/2	12	25,5	20,8	29	-
800806	5/8	16	28,5	24	32	-
800807	3/4	19	32	27,5	36	-
800808	1	25	40	34,5	44,5	-

Notes: If you wish to order a fitting in stainless steel, please change the first two digit from **80....** to **81....** .

STRAIGHT MALE - CONE 24° - ISO 8434-1 (DIN 2353)

Metric parallel thread

Code: **8009..**
Type: **CEL/CES**

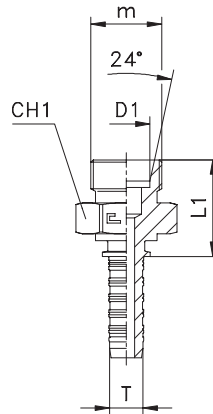

CODE	I.D. hose T			Pipe Ø D1	m	L1	CH1	PN [bar]
	DN	size	INCH					
800901	5	-3	3/16	6L	12x1,5	19,5	12	315
800902	5	-3	3/16	6S	14x1,5	23,5	14	415
800903	5	-3	3/16	8L	14x1,5	20,5	14	315
800904	5	-3	3/16	8S	16x1,5	25,5	17	415
800905	6	-4	1/4	6S	14x1,5	23,5	14	450
800906	6	-4	1/4	8L	14x1,5	20,5	14	315
800907	6	-4	1/4	8S	16x1,5	25,5	17	450
800908	6	-4	1/4	10L	16x1,5	21,5	17	315
800909	6	-4	1/4	10S	18x1,5	25,5	19	450
800910	6	-4	1/4	12L	18x1,5	22,5	19	315
800911	6	-4	1/4	12S	20x1,5	27,5	22	450
800912	8	-5	5/16	10L	16x1,5	22	17	315
800913	8	-5	5/16	10S	18x1,5	26	19	350
800914	8	-5	5/16	12L	18x1,5	23	19	315
800915	8	-5	5/16	12S	20x1,5	28	22	350
800916	10	-6	3/8	12L	18x1,5	23	19	315
800917	10	-6	3/8	12S	20x1,5	28	22	445
800918	10	-6	3/8	14S	22x1,5	30	24	445
800919	10	-6	3/8	15L	22x1,5	24	24	315
800920	12	-8	1/2	14S	22x1,5	30	24	415
800921	12	-8	1/2	15L	22x1,5	24	24	315
800922	12	-8	1/2	16S	24x1,5	30	27	400
800923	12	-8	1/2	18L	26x1,5	25	27	315
800924	16	-10	5/8	18L	26x1,5	25,5	27	315
800925	16	-10	5/8	20S	30x2	34,5	32	350
800926	19	-12	3/4	20S	30x2	35	32	350
800927	19	-12	3/4	22L	30x2	28	32	160
800928	19	-12	3/4	25S	36x2	39	41	350
800929	25	-16	1	25S	36x2	40	41	280
800930	25	-16	1	28L	36x2	30	41	160
800931	25	-16	1	30S	42x2	42	46	280
800932	31	-20	1 1/4	35L	45x2	34	46	160
800933	31	-20	1 1/4	38S	52x2	48	55	210
800934	38	-24	1 1/2	42L	52x2	37	55	160

Notes: If you wish to order a fitting in stainless steel, please change the first two digit from **80....** to **81....** .

STRAIGHT SLIP-ON NUT - 24° CONE WITH O-RING - ISO 8434-1 (DIN 2353)

Metric parallel thread

Code: **8010..**
 Type: **DKOL/DKOS**

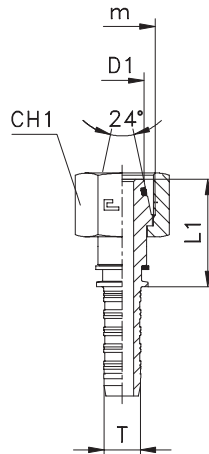

CODE	I.D. hose T			24° cone D1	m	L1	CH1	PN [bar]
	DN	size	INCH					
801001	5	-3	3/16	6L	12x1,5	22,5	14	315
801002	5	-3	3/16	6S	14x1,5	24,5	17	415
801003	5	-3	3/16	8L	14x1,5	23,5	17	315
801004	5	-3	3/16	8S	16x1,5	23,5	19	415
801005	6	-4	1/4	6S	14x1,5	24,5	17	450
801006	6	-4	1/4	8L	14x1,5	23,5	17	315
801007	6	-4	1/4	8S	16x1,5	23,5	19	450
801008	6	-4	1/4	10L	16x1,5	25	19	315
801009	6	-4	1/4	10S	18x1,5	25	22	450
801010	6	-4	1/4	12L	18x1,5	25	22	315
801011	6	-4	1/4	12S	20x1,5	25	24	450
801012	8	-5	5/16	10L	16x1,5	25,5	19	315
801013	8	-5	5/16	10S	18x1,5	25,5	22	350
801014	8	-5	5/16	12L	18x1,5	25,5	22	315
801015	8	-5	5/16	12S	20x1,5	25,5	24	350
801016	10	-6	3/8	12L	18x1,5	25,5	22	315
801017	10	-6	3/8	12S	20x1,5	25,5	24	445
801018	10	-6	3/8	14S	22x1,5	29,5	27	445
801019	10	-6	3/8	15L	22x1,5	26	27	315
801020	12	-8	1/2	14S	22x1,5	29,5	27	415
801021	12	-8	1/2	15L	22x1,5	26	27	315
801022	12	-8	1/2	16S	24x1,5	29,5	30	400
801023	12	-8	1/2	18L	26x1,5	27	32	315
801024	16	-10	5/8	18L	26x1,5	27,5	32	315
801025	16	-10	5/8	20S	30x2	34,5	36	350
801026	19	-12	3/4	20S	30x2	35	36	350
801027	19	-12	3/4	22L	30x2	29,5	36	160
801028	19	-12	3/4	25S	36x2	35	41	350
801029	25	-16	1	25S	36x2	35,5	41	280
801030	25	-16	1	28L	36x2	31	41	160
801031	25	-16	1	30S	42x2	40,5	50	280
801032	31	-20	1 1/4	35L	45x2	36,5	50	160
801033	31	-20	1 1/4	38S	52x2	45	60	210
801034	38	-24	1 1/2	42L	52x2	37,5	60	160

Notes: If you wish to order a fitting in stainless steel, please change the first two digit from **80....** to **81....** .

90° ELBOW SLIP-ON NUT - 24° CONE WITH O-RING - ISO 8434-1 (DIN 2353)

Metric parallel thread

Code: **8011..**

Type: **DKOL90/DKOS90**

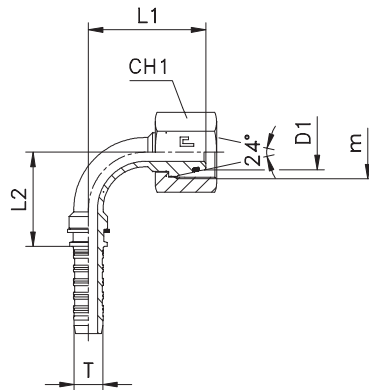

CODE	I.D. hose T			24° cone D1	m	L1	L2	CH1	PN [bar]
	DN	size	INCH						
801101	5	-3	3/16	6L	12x1,5	33	26	14	315
801102	5	-3	3/16	6S	14x1,5	32,5	26	17	415
801103	5	-3	3/16	8L	14x1,5	33	26	17	315
801104	5	-3	3/16	8S	16x1,5	33	26	19	415
801105	6	-4	1/4	6S	14x1,5	34,5	25,5	17	450
801106	6	-4	1/4	8L	14x1,5	33	26	17	315
801107	6	-4	1/4	8S	16x1,5	33	26	19	450
801108	6	-4	1/4	10L	16x1,5	34,5	26	19	315
801109	6	-4	1/4	10S	18x1,5	34,5	26	22	450
801110	6	-4	1/4	12L	18x1,5	35	26	22	315
801111	6	-4	1/4	12S	20x1,5	35	26	24	450
801112	8	-5	5/16	10L	16x1,5	32,5	29	19	315
801113	8	-5	5/16	10S	18x1,5	35	27,5	22	350
801114	8	-5	5/16	12L	18x1,5	35,5	27,5	22	315
801115	8	-5	5/16	12S	20x1,5	35,5	27,5	24	350
801116	10	-6	3/8	12L	18x1,5	37	32	22	315
801117	10	-6	3/8	12S	20x1,5	37	32	24	445
801118	10	-6	3/8	14S	22x1,5	42,5	32	27	445
801119	10	-6	3/8	15L	22x1,5	40,5	32	27	315
801120	12	-8	1/2	14S	22x1,5	43	35,5	27	415
801121	12	-8	1/2	15L	22x1,5	41	35,5	27	315
801122	12	-8	1/2	16S	24x1,5	42,5	35,5	30	400
801123	12	-8	1/2	18L	26x1,5	43,5	35,5	32	315
801124	16	-10	5/8	18L	26x1,5	45,5	40	32	315
801125	16	-10	5/8	20S	30x2	49,5	40	36	350
801126	19	-12	3/4	20S	30x2	53,5	51	36	350
801127	19	-12	3/4	22L	30x2	51,5	51	36	160
801128	19	-12	3/4	25S	36x2	56,5	51	41	350
801129	25	-16	1	25S	36x2	62,5	63	41	280
801130	25	-16	1	28L	36x2	63	63	41	160
801131	25	-16	1	30S	42x2	69,5	63	50	280
801132	31	-20	1 1/4	35L	45x2	80	75,5	50	160
801133	31	-20	1 1/4	38S	52x2	82,5	75,5	60	210
801134	38	-24	1 1/2	42L	52x2	95	101	60	160

Notes: If you wish to order a fitting in stainless steel, please change the first two digit from **80....** to **81....** .

45° ELBOW SLIP-ON NUT - 24° CONE WITH O-RING - ISO 8434-1 (DIN 2353)

Metric parallel thread

Code: **8012..**
Type: **DKOL45/DKOS45**

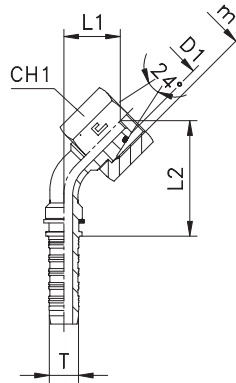

CODE	I.D. hose T			24° cone D1	m	L1	L2	CH1	PN [bar]
	DN	size	INCH						
801201	5	-3	3/16	6L	12x1,5	16,5	46	14	315
801202	5	-3	3/16	6S	14x1,5	16,5	46	17	415
801203	5	-3	3/16	8L	14x1,5	17	46,5	17	315
801204	5	-3	3/16	8S	16x1,5	17	46,5	19	415
801205	6	-4	1/4	6S	14x1,5	17,5	46	17	450
801206	6	-4	1/4	8L	14x1,5	17	46,5	17	315
801207	6	-4	1/4	8S	16x1,5	17	46,5	19	450
801208	6	-4	1/4	10L	16x1,5	17,5	47	19	315
801209	6	-4	1/4	10S	18x1,5	17,5	47	22	450
801210	6	-4	1/4	12L	18x1,5	18,5	47,5	22	315
801211	6	-4	1/4	12S	20x1,5	18,5	47,5	24	450
801212	8	-5	5/16	10L	16x1,5	17,5	48,5	19	315
801213	8	-5	5/16	10S	18x1,5	17,5	48,5	22	350
801214	8	-5	5/16	12L	18x1,5	17,5	49	22	315
801215	8	-5	5/16	12S	20x1,5	18	49	24	350
801216	10	-6	3/8	12L	18x1,5	18,5	54	22	315
801217	10	-6	3/8	12S	20x1,5	18,5	54	24	445
801218	10	-6	3/8	14S	22x1,5	22,5	57,5	27	445
801219	10	-6	3/8	15L	22x1,5	21	56,5	27	315
801220	12	-8	1/2	14S	22x1,5	22	62	27	415
801221	12	-8	1/2	15L	22x1,5	20,5	60	27	315
801222	12	-8	1/2	16S	24x1,5	21,5	61,5	30	400
801223	12	-8	1/2	18L	26x1,5	22,5	62,5	32	315
801224	16	-10	5/8	18L	26x1,5	22,5	67	32	315
801225	16	-10	5/8	20S	30x2	25,5	70	36	350
801226	19	-12	3/4	20S	30x2	26,5	83	36	350
801227	19	-12	3/4	22L	30x2	25,5	81,5	36	160
801228	19	-12	3/4	25S	36x2	29	85	41	350
801229	25	-16	1	25S	36x2	29,5	99,5	41	280
801230	25	-16	1	28L	36x2	29,5	99,5	41	160
801231	25	-16	1	30S	42x2	34	104,5	50	280
801232	31	-20	1 1/4	35L	45x2	37	122	50	160
801233	31	-20	1 1/4	38S	52x2	38,5	123,5	60	210
801234	38	-24	1 1/2	42L	52x2	43	155,5	60	160

Notes: If you wish to order a fitting in stainless steel, please change the first two digit from **80....** to **81....** .

STRAIGHT STANDPIPE - ISO 8434-1 (DIN 2353)

L/S Series

Code: **8013..**
Type: **BEL/BES**

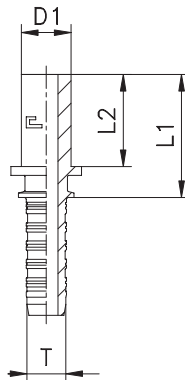

CODE	I.D. hose T			standpipe ØD1	L1	L2	PN [bar]
	DN	size	INCH				
801301	5	-3	3/16	6L/S	24,5	19	415
801302	5	-3	3/16	8L/S	28	22,5	415
801303	6	-4	1/4	6L/S	24,5	19	450
801304	6	-4	1/4	8L/S	28	22,5	450
801305	6	-4	1/4	10L/S	27	21,5	450
801306	6	-4	1/4	12L/S	31	25,5	450
801307	8	-5	5/16	10L/S	27,5	21,5	350
801308	8	-5	5/16	12L/S	31,5	25,5	350
801309	10	-6	3/8	10L/S	27,5	21,5	445
801310	10	-6	3/8	12L/S	31,5	25,5	445
801311	10	-6	3/8	14S	29,5	23,5	445
801312	10	-6	3/8	15L	29	23	315
801313	12	-8	1/2	14S	29,5	23,5	415
801314	12	-8	1/2	15L	29	23	315
801315	12	-8	1/2	16S	30	24	400
801316	12	-8	1/2	18L	27,5	21,5	315
801317	16	-10	5/8	18L	28	21,5	315
801318	16	-10	5/8	20S	34,5	28	350
801319	19	-12	3/4	20S	35	28	350
801320	19	-12	3/4	22L	29,5	22,5	160
801321	19	-12	3/4	25S	38	31	350
801322	25	-16	1	25S	39	31	280
801323	25	-16	1	28L	32	24	160
801324	25	-16	1	30S	42	34	280
801325	31	-20	1 1/4	35L	39,5	30,5	160
801326	31	-20	1 1/4	38S	49	40	210
801327	38	-24	1 1/2	38S	52	40	185
801328	38	-24	1 1/2	42L	42,5	32,5	160

Notes: If you wish to order a fitting in stainless steel, please change the first two digit from **80....** to **81....** .

90° ELBOW STANDPIPE - ISO 8434-1 (DIN 2353)

L/S Series

Code: **8014..**
Type: **BEL90/BES90**

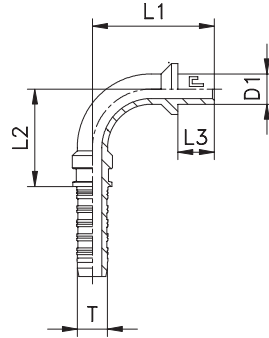

CODE	I.D. hose T			Standpipe Ø D1	L1	L2	L3	PN [bar]
	DN	size	INCH					
801401	5	-3	3/16	6L/S	37	21,5	19	415
801402	5	-3	3/16	8L/S	38,5	21,5	22,5	415
801403	6	-4	1/4	6L/S	37	21,5	19	450
801404	6	-4	1/4	8L/S	38,5	21,5	22,5	450
801405	6	-4	1/4	10L/S	37,5	21,5	21,5	450
801406	6	-4	1/4	12L/S	42,5	21,5	25,5	450
801407	8	-5	5/16	10L/S	43,5	26	21,5	350
801408	8	-5	5/16	12L/S	47,5	26	25,5	350
801409	10	-6	3/8	10L/S	46,5	29,5	21,5	445
801410	10	-6	3/8	12L/S	50,5	29,5	25,5	445
801411	10	-6	3/8	14S	48,5	29,5	23,5	445
801412	10	-6	3/8	15L	48	29,5	23	315
801413	12	-8	1/2	14S	52,5	36	23,5	415
801414	12	-8	1/2	15L	52	36	23	315
801415	12	-8	1/2	16S	53	36	24	400
801416	12	-8	1/2	18L	50,5	36	21,5	315
801417	16	-10	5/8	18L	54,5	40	21,5	315
801418	16	-10	5/8	20S	61	40	28	350
801419	19	-12	3/4	20S	67	50	28	350
801420	19	-12	3/4	22L	61,5	50	22,5	160
801421	19	-12	3/4	25S	70	50	31	350
801422	25	-16	1	25S	79	63	31	280
801423	25	-16	1	28L	72	63	24	160
801424	25	-16	1	30S	82	63	34	280
801425	31	-20	1 1/4	35L	94,5	75,5	30,5	160
801426	31	-20	1 1/4	38S	104	75,5	40	210
801427	38	-24	1 1/2	38S	117,5	101	40	185
801428	38	-24	1 1/2	42L	110	101	32,5	160

Notes: If you wish to order a fitting in stainless steel, please change the first two digit from **80....** to **81....** .

45° ELBOW STANDPIPE - ISO 8434-1 (DIN 2353)

L/S Series

Code: **8015..**
Type: **BEL45/BES45**

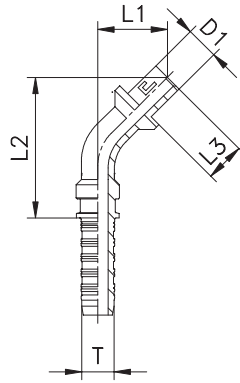

CODE	I.D. hose T			Standpipe Ø D1	L1	L2	L3	PN [bar]
	DN	size	INCH					
801501	5	-3	3/16	6L/S	21,5	45,5	19	415
801502	5	-3	3/16	8L/S	23	47	22,5	415
801503	6	-4	1/4	6L/S	21,5	45,5	19	450
801504	6	-4	1/4	8L/S	23	47	22,5	450
801505	6	-4	1/4	10L/S	22	46	21,5	450
801506	6	-4	1/4	12L/S	25,5	49,5	25,5	450
801507	8	-5	5/16	10L/S	25	53,5	21,5	350
801508	8	-5	5/16	12L/S	28	56,5	25,5	350
801509	10	-6	3/8	10L/S	26	59	21,5	445
801510	10	-6	3/8	12L/S	29	61,5	25,5	445
801511	10	-6	3/8	14S	27,5	60,5	23,5	445
801512	10	-6	3/8	15L	27	60	23	315
801513	12	-8	1/2	14S	29	69	23,5	415
801514	12	-8	1/2	15L	28,5	68,5	23	315
801515	12	-8	1/2	16S	29	69	24	400
801516	12	-8	1/2	18L	27,5	67,5	21,5	315
801517	16	-10	5/8	18L	28,5	73,5	21,5	315
801518	16	-10	5/8	20S	33,5	78	28	350
801519	19	-12	3/4	20S	36	91,5	28	350
801520	19	-12	3/4	22L	32,5	88	22,5	160
801521	19	-12	3/4	25S	38,5	94	31	350
801522	25	-16	1	25S	41	111,5	31	280
801523	25	-16	1	28L	36	106,5	24	160
801524	25	-16	1	30S	43	113,5	34	280
801525	31	-20	1 1/4	35L	47	132	30,5	160
801526	31	-20	1 1/4	38S	53,5	139	40	210
801527	38	-24	1 1/2	38S	59	172	40	185
801528	38	-24	1 1/2	42L	54	166,5	32,5	160

Notes: If you wish to order a fitting in stainless steel, please change the first two digit from **80....** to **81....** .

STRAIGHT - JIC 74° CONE - ISO 8434-2 (SAE J514)

UNF/UN-2A thread

Code: **8016..**

Type: **AGJ**

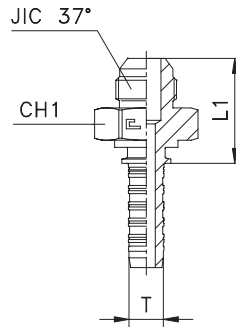

CODE	I.D. hose T			Pipe Ø JIC 37°		JIC 37°	L1	CH1	PN [bar]
	DN	size	INCH	M	W				
801601	5	-3	3/16	6	1/4	7/16-20	26,5	12	415
801602	5	-3	3/16	8	5/16	1/2-20	26,5	14	415
801603	6	-4	1/4	6	1/4	7/16-20	26,5	12	450
801604	6	-4	1/4	8	5/16	1/2-20	26,5	14	450
801605	6	-4	1/4	10	3/8	9/16-18	27,5	17	350
801606	8	-5	5/16	10	3/8	9/16-18	28	17	350
801607	10	-6	3/8	10	3/8	9/16-18	28	17	350
801608	10	-6	3/8	12	1/2	3/4-16	30,5	22	350
801609	10	-6	3/8	14-15-16	5/8	7/8-14	34,5	24	350
801610	12	-8	1/2	12	1/2	3/4-16	30,5	22	350
801611	12	-8	1/2	14-15-16	5/8	7/8-14	34,5	24	350
801612	12	-8	1/2	18-20	3/4	1 1/16-12	39	30	350
801613	16	-10	5/8	14-15-16	5/8	7/8-14	35	24	350
801614	16	-10	5/8	18-20	3/4	1 1/16-12	39,5	30	350
801615	19	-12	3/4	18-20	3/4	1 1/16-12	40	30	350
801616	19	-12	3/4	22	7/8	1 3/16-12	40,5	32	290
801617	19	-12	3/4	25	1	1 5/16-12	41	36	290
801618	25	-16	1	25	1	1 5/16-12	42	36	280
801619	25	-16	1	30-32	1 1/4	1 5/8-12	45	46	240
801620	31	-20	1 1/4	30-32	1 1/4	1 5/8-12	46	46	210
801621	31	-20	1 1/4	38	1 1/2	1 7/8-12	51,5	50	210
801622	38	-24	1 1/2	38	1 1/2	1 7/8-12	52,5	50	185
801623	51	-32	2	50	2	2 1/2-12	63,5	65	100

Notes: If you wish to order a fitting in stainless steel, please change the first two digit from **80....** to **81....** .

STRAIGHT CRIMPED-BACK NUT - JIC 74° CONE - ISO 8434-2 (SAE J514)

UNF/UN-2B thread

Code: 8017..

Type: DKJ

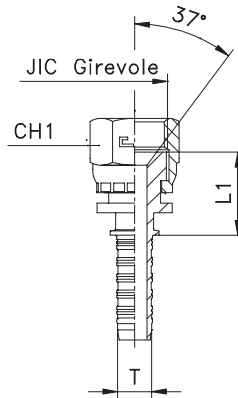

CODE	I.D. hose T			JIC 37°	L1	CH1	PN [bar]
	DN	size	INCH				
801701	5	-3	3/16	7/16-20	13,5	14	415
801702	5	-3	3/16	1/2-20	13,5	17	415
801703	6	-4	1/4	7/16-20	13,5	14	450
801704	6	-4	1/4	1/2-20	13,5	17	450
801705	6	-4	1/4	9/16-18	13,5	19	350
801706	8	-5	5/16	9/16-18	14	19	350
801707	10	-6	3/8	9/16-18	14	19	350
801708	10	-6	3/8	3/4-16	17	24	350
801709	10	-6	3/8	7/8-14	17	27	350
801710	12	-8	1/2	3/4-16	17	24	350
801711	12	-8	1/2	7/8-14	17	27	350
801712	12	-8	1/2	1 1/16-12	19,5	32	350
801713	16	-10	5/8	7/8-14	17,5	27	350
801714	16	-10	5/8	1 1/16-12	20	32	350
801715	19	-12	3/4	1 1/16-12	20,5	32	350
801716	19	-12	3/4	1 3/16-12	20,5	36	290
801717	19	-12	3/4	1 5/16-12	21,5	41	290
801718	25	-16	1	1 5/16-12	22	41	280

Notes: If you wish to order a fitting in stainless steel, please change the first two digit from 80.... to 81.... .

STRAIGHT THURST-WIRE/SLIP-ON NUT - JIC 74° CONE - ISO 8434-2 (SAE J514)

UNF/UN-2B thread

Code: **8018..**

Type: **DKJ**

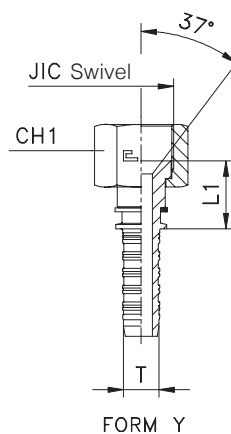
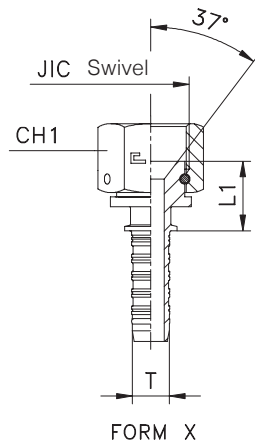

CODE	I.D. hose T			JIC 37°	FORM	L1	CH1	PN [bar]
	DN	size	INCH					
801801	5	-3	3/16	7/16-20	X	14	14	415
801802	5	-3	3/16	1/2-20	X	15	17	415
801803	6	-4	1/4	7/16-20	X	14	14	450
801804	6	-4	1/4	1/2-20	X	15	17	450
801805	6	-4	1/4	9/16-18	X	16,5	19	350
801806	8	-5	5/16	9/16-18	X	17	19	350
801807	10	-6	3/8	9/16-18	X	17	19	350
801808	10	-6	3/8	3/4-16	X	17	22	350
801809	10	-6	3/8	7/8-14	X	19	27	350
801810	12	-8	1/2	3/4-16	X	17	22	350
801811	12	-8	1/2	7/8-14	X	19	27	350
801812	12	-8	1/2	1 1/16-12	X	18,5	32	350
801813	16	-10	5/8	7/8-14	X	19,5	27	350
801814	16	-10	5/8	1 1/16-12	X	19	32	350
801815	19	-12	3/4	1 1/16-12	X	19,5	32	350
801816	19	-12	3/4	1 3/16-12	X	21	36	290
801817	19	-12	3/4	1 5/16-12	X	21	41	290
801818	25	-16	1	1 5/16-12	X	22,5	41	280
801819	25	-16	1	1 5/8-12	X	23	50	240
801820	31	-20	1 1/4	1 5/8-12	X	24	50	210
801821	31	-20	1 1/4	1 7/8-12	X	28	60	210
801822	38	-24	1 1/2	1 7/8-12	X	29	60	185
801823	51	-32	2	2 1/2-12	X	32,5	75	100
801851	5	-3	3/16	7/16-20	Y	15	14	415
801852	5	-3	3/16	1/2-20	Y	16	17	415
801855	6	-4	1/4	9/16-18	Y	17,5	19	350
801856	8	-5	5/16	9/16-18	Y	18	19	350
801858	10	-6	3/8	3/4-16	Y	18	22	350
801859	10	-6	3/8	7/8-14	Y	20	27	350
801861	12	-8	1/2	7/8-14	Y	20	27	350
801862	12	-8	1/2	1 1/16-12	Y	19,5	32	350
801864	16	-10	5/8	1 1/16-12	Y	20	32	350
801866	19	-12	3/4	1 3/16-12	Y	22	36	290
801867	19	-12	3/4	1 5/16-12	Y	22	41	290
801869	25	-16	1	1 5/8-12	Y	24	50	240
801871	31	-20	1 1/4	1 7/8-12	Y	29	60	210

Notes: If you wish to order a fitting in stainless steel, please change the first two digit from **80....** to **81....**

90° ELBOW CRIMPED-BACK NUT - JIC 74° CONE - ISO 8434-2 (SAE J514)
UNF/UN-2B thread

Code: **8019..**
Type: **DKJ90**

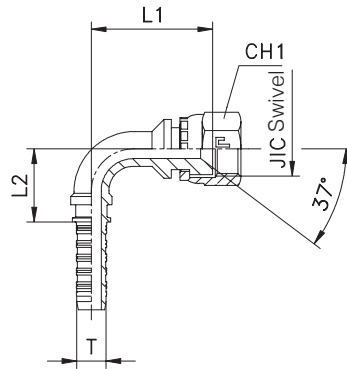

CODE	I.D. hose T			JIC 37°	L1	L2	CH1	PN [bar]
	DN	size	INCH					
801901	5	-3	3/16	7/16-20	24,5	21,5	14	415
801902	5	-3	3/16	1/2-20	24,5	21,5	17	415
801903	6	-4	1/4	7/16-20	24,5	21,5	14	450
801904	6	-4	1/4	1/2-20	24,5	21,5	17	450
801905	6	-4	1/4	9/16-18	25,5	21,5	19	350
801906	8	-5	5/16	9/16-18	30,5	26	19	350
801907	10	-6	3/8	9/16-18	34,5	29,5	19	350
801908	10	-6	3/8	3/4-16	38	29,5	24	350
801909	10	-6	3/8	7/8-14	39	29,5	27	350
801910	12	-8	1/2	3/4-16	39,5	36	24	350
801911	12	-8	1/2	7/8-14	40,5	36	27	350
801912	12	-8	1/2	1 1/16-12	45	36	32	350
801913	16	-10	5/8	7/8-14	43,5	40	27	350
801914	16	-10	5/8	1 1/16-12	48	40	32	350
801915	19	-12	3/4	1 1/16-12	52	50	32	350
801916	19	-12	3/4	1 3/16-12	56	50	36	290
801917	19	-12	3/4	1 5/16-12	56	50	41	290
801918	25	-16	1	1 5/16-12	62	63	41	280

Notes: If you wish to order a fitting in stainless steel, please change the first two digit from **80....** to **81....** .

90° ELBOW THURST-WIRE/SLIP-ON NUT - JIC 74° CONE - ISO 8434-2 (SAE J514)

UNF/UN-2B thread

Code: **8020..**
Type: **DKJ90**

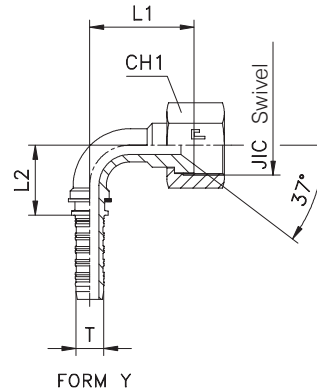
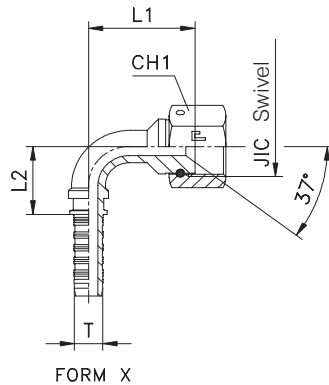

CODE	I.D. hose T			JIC 37°	FORM	L1	L2	CH1	PN [bar]
	DN	size	INCH						
802001	5	-3	3/16	7/16-20	X	25	21,5	14	415
802002	5	-3	3/16	1/2-20	X	26	21,5	17	415
802003	6	-4	1/4	7/16-20	X	25	21,5	14	450
802004	6	-4	1/4	1/2-20	X	26	21,5	17	450
802005	6	-4	1/4	9/16-18	X	28,5	21,5	19	350
802006	8	-5	5/16	9/16-18	X	33,5	26	19	350
802007	10	-6	3/8	9/16-18	X	36	29,5	19	350
802008	10	-6	3/8	3/4-16	X	38	29,5	22	350
802009	10	-6	3/8	7/8-14	X	42,5	29	27	350
802010	12	-8	1/2	3/4-16	X	39,5	36	22	350
802011	12	-8	1/2	7/8-14	X	42,5	36	27	350
802012	12	-8	1/2	1 1/16-12	X	44	36	32	350
802013	16	-10	5/8	7/8-14	X	45,5	40	27	350
802014	16	-10	5/8	1 1/16-12	X	47	40	32	350
802015	19	-12	3/4	1 1/16-12	X	51	50	32	350
802016	19	-12	3/4	1 3/16-12	X	56,5	50	36	290
802017	19	-12	3/4	1 5/16-12	X	56,5	50	41	290
802018	25	-16	1	1 5/16-12	X	62,5	63	41	280
802019	25	-16	1	1 5/8-12	X	67	63	50	240
802020	31	-20	1 1/4	1 5/8-12	X	80	75,5	50	210
802021	31	-20	1 1/4	1 7/8-12	X	87	75,5	60	210
802022	38	-24	1 1/2	1 7/8-12	X	97,5	101	60	185
802023	51	-32	2	2 1/2-12	X	123,5	137,5	75	100
802051	5	-3	3/16	7/16-20	Y	27,5	26	14	415
802052	5	-3	3/16	1/2-20	Y	30	26	17	415
802055	6	-4	1/4	9/16-18	Y	31,5	26	19	350
802058	10	-6	3/8	3/4-16	Y	35	32	22	350
802059	10	-6	3/8	7/8-14	Y	38,5	32	27	350
802062	12	-8	1/2	1 1/16-12	Y	41	35,5	32	350
802064	16	-10	5/8	1 1/16-12	Y	43	40	32	350
802066	19	-12	3/4	1 3/16-12	Y	49,5	50	36	290
802067	19	-12	3/4	1 5/16-12	Y	51	50	41	290
802069	25	-16	1	1 5/8-12	Y	62	76,3	50	240
802071	31	-20	1 1/4	1 7/8-12	Y	80	75,5	60	210

Notes: If you wish to order a fitting in stainless steel, please change the first two digit from **80....** to **81....** .

90° COMPACT ELBOW THURST-WIRE - JIC 74° CONE - ISO 8434-2 (SAE J514)
UNF/UN-2B thread

Code: **8021..**
Type: **DKJ90-K**

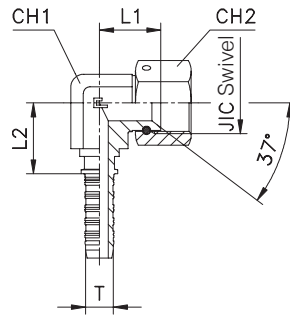

CODE	I.D. hose T			JIC 37°	L1	L2	CH1	CH2	PN [bar]
	DN	size	INCH						
802101	5	-3	3/16	7/16-20	17	16,5	11	14	415
802102	6	-4	1/4	1/2-20	17	18,5	14	17	450
802103	8	-5	5/16	9/16-18	22	22,5	19	19	350
802104	10	-6	3/8	3/4-16	24	23	19	22	350
802105	12	-8	1/2	7/8-14	28	25,5	22	27	350
802106	16	-10	5/8	1 1/16-12	30	29	27	32	350
802107	19	-12	3/4	1 3/16-12	34,5	34,5	33	36	290
802108	25	-16	1	1 5/16-12	35	40	33	41	290

Notes: If you wish to order a fitting in stainless steel, please change the first two digit from **80....** to **81....** .

45° ELBOW CRIMPED-BACK NUT - JIC 74° CONE - ISO 8434-2 (SAE J514)
UNF/UN-2B thread

Code: **8022..**
Type: **DKJ45**

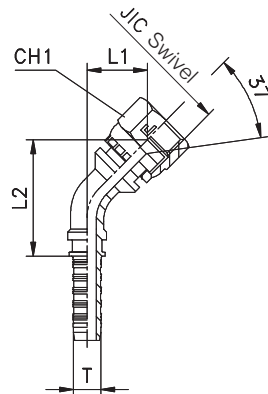

CODE	I.D. hose T			JIC 37°	L1	L2	CH1	PN [bar]
	DN	size	INCH					
802201	5	-3	3/16	7/16-20	13	37	14	415
802202	5	-3	3/16	1/2-20	13	37	17	415
802203	6	-4	1/4	7/16-20	13	37	14	450
802204	6	-4	1/4	1/2-20	13	37	17	450
802205	6	-4	1/4	9/16-18	13,5	37,5	19	350
802206	8	-5	5/16	9/16-18	16	44,5	19	350
802207	10	-6	3/8	9/16-18	18	50	19	350
802208	10	-6	3/8	3/4-16	20	52,5	24	350
802209	10	-6	3/8	7/8-14	21	53,5	27	350
802210	12	-8	1/2	3/4-16	20	60	24	350
802211	12	-8	1/2	7/8-14	20,5	60,5	27	350
802212	12	-8	1/2	1 1/16-12	23,5	64	32	350
802213	16	-10	5/8	7/8-14	21	65,5	27	350
802214	16	-10	5/8	1 1/16-12	24,5	68,5	32	350
802215	19	-12	3/4	1 1/16-12	25,5	81	32	350
802216	19	-12	3/4	1 3/16-12	28,5	84	36	290
802217	19	-12	3/4	1 5/16-12	28,5	84	41	290
802218	25	-16	1	1 5/16-12	29	99	41	280

Notes: If you wish to order a fitting in stainless steel, please change the first two digit from **80....** to **81....** .

45° ELBOW THURST-WIRE/SLIP-ON NUT - JIC 74° CONE - ISO 8434-2 (SAE J514)
UNF/UN-2B thread

Code: **8023..**
Type: **DKJ45**

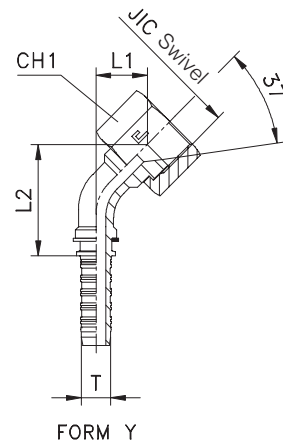
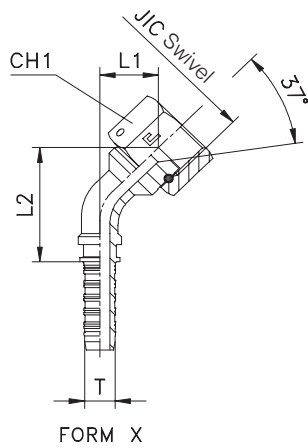

CODE	I.D. hose T			JIC 37°	FORM	L1	L2	CH1	PN [bar]
	DN	size	INCH						
802301	5	-3	3/16	7/16-20	X	13	36	14	415
802302	5	-3	3/16	1/2-20	X	14	37	17	415
802303	6	-4	1/4	7/16-20	X	13	36	14	450
802304	6	-4	1/4	1/2-20	X	14	37	17	450
802305	6	-4	1/4	9/16-18	X	15	37,5	19	350
802306	8	-5	5/16	9/16-18	X	17,5	46	19	350
802307	10	-6	3/8	9/16-18	X	18,5	50	19	350
802308	10	-6	3/8	3/4-16	X	20	49,5	22	350
802309	10	-6	3/8	7/8-14	X	22	50,5	27	350
802310	12	-8	1/2	3/4-16	X	19,5	57,5	22	350
802311	12	-8	1/2	7/8-14	X	22	59	27	350
802312	12	-8	1/2	1 1/16-12	X	23	58	32	350
802313	16	-10	5/8	7/8-14	X	22,5	65,5	27	350
802314	16	-10	5/8	1 1/16-12	X	23,5	65	32	350
802315	19	-12	3/4	1 1/16-12	X	25	80,5	32	350
802316	19	-12	3/4	1 3/16-12	X	29	84,5	36	290
802317	19	-12	3/4	1 5/16-12	X	29	84,5	41	290
802318	25	-16	1	1 5/16-12	X	29,5	97,5	41	280
802319	25	-16	1	1 5/8-12	X	32,5	96,5	50	240
802320	31	-20	1 1/4	1 5/8-12	X	36,5	119	50	210
802321	31	-20	1 1/4	1 7/8-12	X	41,5	121	60	210
802322	38	-24	1 1/2	1 7/8-12	X	45	155	60	185
802323	51	-32	2	2 1/2-12	X	55	204	75	100
802351	5	-3	3/16	7/16-20	Y	13	42	14	415
802352	5	-3	3/16	1/2-20	Y	14,5	43	17	415
802355	6	-4	1/4	9/16-18	Y	16	45	19	350
802358	10	-6	3/8	3/4-16	Y	17	52,5	22	350
802359	10	-6	3/8	7/8-14	Y	19,5	55	27	350
802362	12	-8	1/2	1 1/16-12	Y	21	60,5	32	350
802364	16	-10	5/8	1 1/16-12	Y	21	65,5	32	350
802366	19	-12	3/4	1 3/16-12	Y	24	80,5	36	290
802367	19	-12	3/4	1 5/16-12	Y	25	81,5	41	290
802369	25	-16	1	1 5/8-12	Y	29	99	50	240
802371	31	-20	1 1/4	1 7/8-12	Y	37	122	60	210

Notes: If you wish to order a fitting in stainless steel, please change the first two digit from **80....** to **81....** .

STRAIGHT - 60° CONE - ISO 8434-6 (BS 5200)

BSP taper thread

Code: **8024..**
Type: **AGR-K**

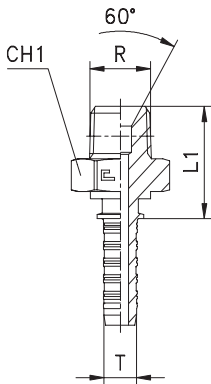

STRAIGHT - 60° CONE

Thread NPTF

Code: **8025..**
Type: **AGN**

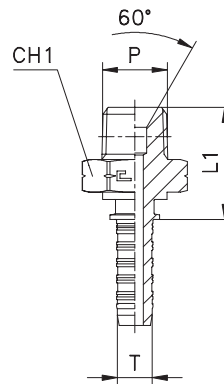

CODE	I.D. hose T			R	L1	CH1	PN [bar]
	DN	size	INCH				
802401	5	-3	3/16	1/8	20	12	350
802402	5	-3	3/16	1/4	25	14	350
802403	6	-4	1/4	1/8	20	12	350
802404	6	-4	1/4	1/4	25	14	350
802405	6	-4	1/4	3/8	25	17	250
802406	8	-5	5/16	1/4	25,5	14	350
802407	8	-5	5/16	3/8	25,5	17	250
802408	10	-6	3/8	3/8	25,5	17	250
802409	10	-6	3/8	1/2	31	22	225
802410	12	-8	1/2	3/8	26,5	22	250
802411	12	-8	1/2	1/2	31	22	225
802412	16	-10	5/8	3/4	33,5	27	200
802413	19	-12	3/4	3/4	34	27	200
802414	19	-12	3/4	1	40	36	160
802415	25	-16	1	1	41	36	160
802416	25	-16	1	1 1/4	44	46	160
802417	31	-20	1 1/4	1 1/4	45	46	160
802418	38	-24	1 1/2	1 1/2	49	50	160
802419	51	-32	2	2	53	65	100

Notes: If you wish to order a fitting in stainless steel, please change the first two digit from 80.... to 81.... .

CODE	I.D. hose T			P	L1	CH1	PN [bar]
	DN	size	INCH				
802501	5	-3	3/16	1/8	20	12	350
802502	5	-3	3/16	1/4	25	14	350
802503	6	-4	1/4	1/8	20	12	350
802504	6	-4	1/4	1/4	25	14	350
802505	6	-4	1/4	3/8	25	17	250
802506	8	-5	5/16	1/4	25,5	14	350
802507	8	-5	5/16	3/8	25,5	17	250
802508	10	-6	3/8	3/8	25,5	17	250
802509	10	-6	3/8	1/2	31	22	225
802510	12	-8	1/2	3/8	26,5	22	250
802511	12	-8	1/2	1/2	31	22	225
802512	16	-10	5/8	3/4	33,5	27	200
802513	19	-12	3/4	3/4	34	27	200
802514	19	-12	3/4	1	40	36	160
802515	25	-16	1	1	41	36	160
802516	25	-16	1	1 1/4	44	46	160
802517	31	-20	1 1/4	1 1/4	45	46	160
802518	38	-24	1 1/2	1 1/2	49	50	160
802519	51	-32	2	2	53	65	100

Notes: If you wish to order a fitting in stainless steel, please change the first two digit from 80.... to 81.... .

STRAIGHT - 60° CONE - ISO 8434-6 (BS 5200)

Thread BSP Parallel

Code: **8026..**

Type: **AGR**

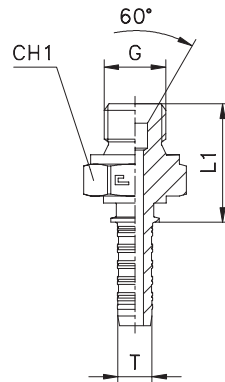

CODE	I.D. hose T			G	L1	CH1	PN [bar]
	DN	size	INCH				
802601	5	-3	3/16	1/8	19	14	400
802602	5	-3	3/16	1/4	22,5	19	400
802603	6	-4	1/4	1/8	19	14	400
802604	6	-4	1/4	1/4	22,5	19	400
802605	6	-4	1/4	3/8	25,5	22	400
802606	8	-5	5/16	1/4	23	19	350
802607	8	-5	5/16	3/8	26	22	350
802608	10	-6	3/8	1/4	23	19	400
802609	10	-6	3/8	3/8	26	22	400
802610	10	-6	3/8	1/2	29,5	27	350
802611	12	-8	1/2	3/8	26	22	400
802612	12	-8	1/2	1/2	29,5	27	350
802613	12	-8	1/2	5/8	32	30	350
802614	12	-8	1/2	3/4	33	32	315
802615	16	-10	5/8	5/8	32,5	30	350
802616	16	-10	5/8	3/4	33,5	32	315
802617	19	-12	3/4	3/4	34	32	315
802618	19	-12	3/4	1	38,5	41	250
802619	25	-16	1	1	39	41	250
802620	25	-16	1	1 1/4	40	50	200
802621	31	-20	1 1/4	1 1/4	45,5	50	200
802622	31	-20	1 1/4	1 1/2	46	55	160
802623	38	-24	1 1/2	1 1/2	49,5	55	160
802624	38	-24	1 1/2	2	55	70	125
802625	51	-32	2	2	58,5	70	125
802626	6	-4	1/4	1/2	29	27	350
802627	8	-5	5/16	1/2	29,5	27	350

Notes: If you wish to order a fitting in stainless steel, please change the first two digit from **80....** to **81....** .

STRAIGHT CRIMPED-BACK NUT - 60° CONE - ISO 8434-6 (BS 5200)

Thread BSP Parallel

Code: **8027..**

Type: **DKR**

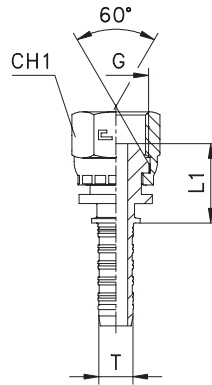

CODE	I.D. hose T			G	L1	CH1	PN [bar]
	DN	size	INCH				
802701	5	-3	3/16	1/8	15,5	14	350
802702	5	-3	3/16	1/4	15,5	19	350
802703	6	-4	1/4	1/8	15,5	14	350
802704	6	-4	1/4	1/4	15,5	19	350
802705	6	-4	1/4	3/8	17,5	22	350
802706	8	-5	5/16	1/4	16	19	350
802707	8	-5	5/16	3/8	18	22	350
802708	10	-6	3/8	1/4	16	19	350
802709	10	-6	3/8	3/8	18	22	350
802710	10	-6	3/8	1/2	19	27	315
802711	12	-8	1/2	3/8	18	22	350
802712	12	-8	1/2	1/2	19	27	315
802713	12	-8	1/2	5/8	19,5	30	315
802714	12	-8	1/2	3/4	21,5	32	250
802715	16	-10	5/8	5/8	20	30	315
802716	16	-10	5/8	3/4	22	32	250
802717	19	-12	3/4	3/4	22,5	32	250
802718	19	-12	3/4	1	23,5	41	200
802719	25	-16	1	1	24	41	200

Notes: If you wish to order a fitting in stainless steel, please change the first two digit from **80....** to **81....** .

STRAIGHT THURST-WIRE/SLIP-ON NUT - 60° CONE WITH O-RING - ISO 8434-6 (BS 5200)

Thread BSP Parallel

Code: **8028..**
Type: **DKOR**

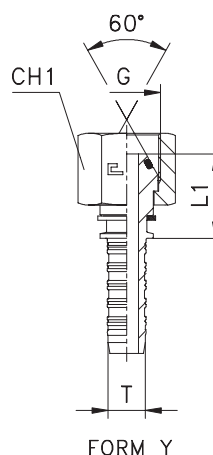
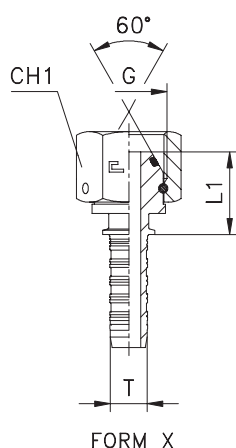

CODE	I.D. hose T			G	FORM	L1	CH1	PN [bar]
	DN	size	INCH					
802801	5	-3	3/16	1/8	X	16	14	400
802802	5	-3	3/16	1/4	X	19	19	400
802803	6	-4	1/4	1/8	X	16	14	400
802804	6	-4	1/4	1/4	X	19	19	400
802805	6	-4	1/4	3/8	X	19	22	400
802806	8	-5	5/16	1/4	X	19,5	19	350
802807	8	-5	5/16	3/8	X	19,5	22	350
802808	10	-6	3/8	1/4	X	19,5	19	400
802809	10	-6	3/8	3/8	X	19,5	22	400
802810	10	-6	3/8	1/2	X	22,5	27	350
802811	12	-8	1/2	3/8	X	19,5	22	400
802812	12	-8	1/2	1/2	X	22,5	27	350
802813	12	-8	1/2	5/8	X	22,5	30	350
802814	12	-8	1/2	3/4	X	22,5	32	315
802815	16	-10	5/8	5/8	X	23	30	350
802816	16	-10	5/8	3/4	X	23	32	315
802817	19	-12	3/4	3/4	X	23,5	32	315
802818	19	-12	3/4	1	X	29,5	41	250
802819	25	-16	1	1	X	30	41	250
802820	25	-16	1	1 1/4	X	32	50	200
802821	31	-20	1 1/4	1 1/4	X	33	50	200
802822	31	-20	1 1/4	1 1/2	X	35	55	160
802823	38	-24	1 1/2	1 1/2	X	36	55	160
802824	38	-24	1 1/2	2	X	37	70	125
802825	51	-32	2	2	X	38	70	125
802826	6	-4	1/4	1/2	X	22	27	350
802827	8	-5	5/16	1/2	X	22,5	27	350
802852	5	-3	3/16	1/4	Y	20	19	400
802854	6	-4	1/4	1/4	Y	20	19	400
802855	6	-4	1/4	3/8	Y	20	22	400
802857	8	-5	5/16	3/8	Y	20,5	22	350
802859	10	-6	3/8	3/8	Y	20,5	22	400
802860	10	-6	3/8	1/2	Y	23,5	27	350
802862	12	-8	1/2	1/2	Y	23,5	27	350
802863	12	-8	1/2	5/8	Y	23,5	30	350
802864	12	-8	1/2	3/4	Y	23,5	32	315
802866	16	-10	5/8	3/4	Y	24	32	315
802868	19	-12	3/4	1	Y	29,5	41	250
802870	25	-16	1	1 1/4	Y	33	50	200
802871	31	-20	1 1/4	1 1/4	Y	34	50	200
802872	31	-20	1 1/4	1 1/2	Y	36	55	160
802873	38	-24	1 1/2	1 1/2	Y	37	55	160
802874	38	-24	1 1/2	2	Y	38	70	125
802876	6	-4	1/4	1/2	Y	23	27	350
802877	8	-5	5/16	1/2	Y	23,5	27	350

Notes: If you wish to order a fitting in stainless steel, please change the first two digit from 80.... to 81....

90° ELBOW CRIMPED-BACK NUT - 60° CONE - ISO 8434-6 (BS 5200)

Thread BSP Parallel

Code: **8029..**

Type: **DKR90**

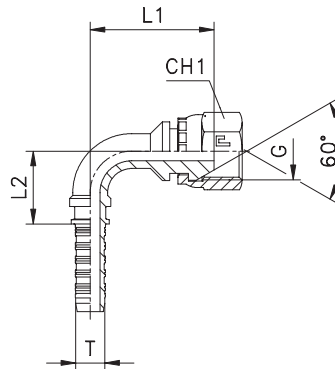

CODE	I.D. hose T			G	L1	L2	CH1	PN [bar]
	DN	size	INCH					
802901	5	-3	3/16	1/8	26,5	21	14	350
802902	5	-3	3/16	1/4	26	21	19	350
802903	6	-4	1/4	1/8	26,5	21	14	350
802904	6	-4	1/4	1/4	26,5	21	19	350
802905	6	-4	1/4	3/8	30,5	21	22	350
802906	8	-5	5/16	1/4	32	25,5	19	350
802907	8	-5	5/16	3/8	35	25,5	22	350
802908	10	-6	3/8	1/4	34,5	29	19	350
802909	10	-6	3/8	3/8	36,5	29	22	350
802910	10	-6	3/8	1/2	39,5	29	27	315
802911	12	-8	1/2	3/8	40,5	35,5	22	350
802912	12	-8	1/2	1/2	41,5	35,5	27	315
802913	12	-8	1/2	5/8	43	35,5	30	315
802914	12	-8	1/2	3/4	47,5	35,5	32	250
802915	16	-10	5/8	5/8	45	39,5	30	315
802916	16	-10	5/8	3/4	49	39,5	32	250
802917	19	-12	3/4	3/4	52,5	49,5	32	250
802918	19	-12	3/4	1	56	50	41	200
802919	25	-16	1	1	62	63	41	200

Notes: If you wish to order a fitting in stainless steel, please change the first two digit from **80....** to **81....** .

90° ELBOW THURST-WIRE/SLIP-ON NUT - 60° CONE WITH O-RING - ISO 8434-6 (BS 5200)

Thread BSP Parallel

Code: **8030..**
Type: **DKOR90**

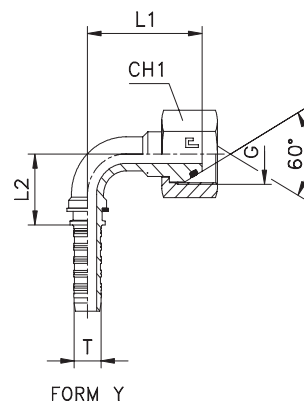
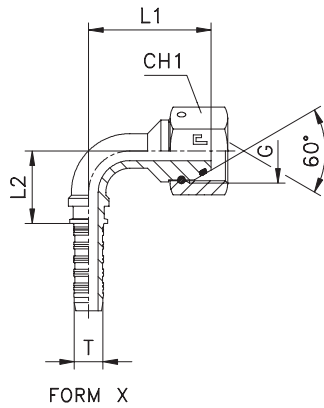

CODE	I.D. hose T			G	FORM	L1	L2	CH1	PN [bar]
	DN	size	INCH						
803001	5	-3	3/16	1/8	X	26	21,5	14	400
803002	5	-3	3/16	1/4	X	29	21,5	19	400
803003	6	-4	1/4	1/8	X	27	21,5	14	400
803004	6	-4	1/4	1/4	X	30	21,5	19	400
803005	6	-4	1/4	3/8	X	32	21,5	22	400
803006	8	-5	5/16	1/4	X	36	26	19	350
803007	8	-5	5/16	3/8	X	37	26	22	350
803008	10	-6	3/8	1/4	X	40	29,5	19	400
803009	10	-6	3/8	3/8	X	38,5	29,5	22	400
803010	10	-6	3/8	1/2	X	43,5	29,5	27	350
803011	12	-8	1/2	3/8	X	44	36	22	400
803012	12	-8	1/2	1/2	X	45	36	27	350
803013	12	-8	1/2	5/8	X	46	36	30	350
803014	12	-8	1/2	3/4	X	48	36	32	315
803015	16	-10	5/8	5/8	X	49	40	30	350
803016	16	-10	5/8	3/4	X	51	40	32	315
803017	19	-12	3/4	3/4	X	55	50	32	315
803018	19	-12	3/4	1	X	64	50	41	250
803019	25	-16	1	1	X	70	63	41	250
803020	25	-16	1	1 1/4	X	76	63	50	200
803021	31	-20	1 1/4	1 1/4	X	89	75,5	50	200
803022	31	-20	1 1/4	1 1/2	X	94	75,5	55	160
803023	38	-24	1 1/2	1 1/2	X	104,5	101	55	160
803024	38	-24	1 1/2	2	X	111,5	101	70	125
803025	51	-32	2	2	X	127	137,5	70	125
803026	6	-4	1/4	1/2	X	37,5	21,5	27	350
803027	8	-5	5/16	1/2	X	42	26	27	350
803052	5	-3	3/16	1/4	Y	33	26	19	400
803054	6	-4	1/4	1/4	Y	33	26	19	400
803055	6	-4	1/4	3/8	Y	35	26	22	400
803057	8	-5	5/16	3/8	Y	35,5	27,5	22	350
803059	10	-6	3/8	3/8	Y	37	32	22	400
803060	10	-6	3/8	1/2	Y	42	32	27	350
803062	12	-8	1/2	1/2	Y	42,5	35,5	27	350
803063	12	-8	1/2	5/8	Y	43	35,5	30	350
803064	12	-8	1/2	3/4	Y	44,5	35,5	32	315
803066	16	-10	5/8	3/4	Y	46,5	40	32	315
803068	19	-12	3/4	1	Y	59	51	41	250
803070	25	-16	1	1 1/4	Y	72,5	63	50	200
803071	31	-20	1 1/4	1 1/4	Y	83	75,5	50	200
803072	31	-20	1 1/4	1 1/2	Y	88,5	75,5	55	160
803073	38	-24	1 1/2	1 1/2	Y	99	100,5	55	160
803074	38	-24	1 1/2	2	Y	105,5	101	70	125
803076	6	-4	1/4	1/2	Y	40	26	27	350
803077	8	-5	5/16	1/2	Y	40,5	27,5	27	350

Notes: If you wish to order a fitting in stainless steel, please change the first two digit from **80....** to **81....**

90° COMPACT ELBOW THURST-WIRE - 60° CONE WITH O-RING - ISO 8434-6 (BS 5200)

Thread BSP Parallel

Code: **8031..**
Type: **DKOR90-K**

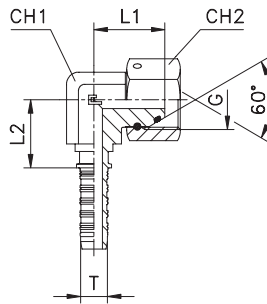

CODE	I.D. hose T			G	L1	L2	CH1	CH2	PN [bar]
	DN	size	INCH						
803101	5	-3	3/16	1/8	22	16,5	11	14	400
803102	6	-4	1/4	1/4	28,5	18,5	14	19	400
803103	8	-5	5/16	3/8	32	22,5	19	22	350
803104	10	-6	3/8	3/8	32	23	19	22	400
803105	12	-8	1/2	1/2	38	25,5	22	27	350
803106	16	-10	5/8	5/8	42	29	27	30	350
803107	19	-12	3/4	3/4	43	32,5	27	32	315
803108	25	-16	1	1	47	40	33	41	250

Notes: If you wish to order a fitting in stainless steel, please change the first two digit from **80....** to **81....** .

45° ELBOW CRIMPED-BACK NUT - JIC 74° CONE - ISO 8434-6 (BS 5200)

Thread BSP Parallel

Code: **8032..**
Type: **DKR45**

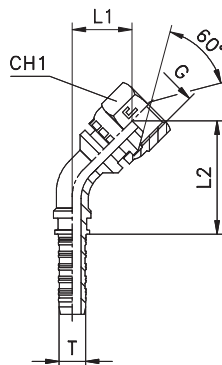

CODE	I.D. hose T			G	L1	L2	CH1	PN [bar]
	DN	size	INCH					
803201	5	-3	3/16	1/8	13,5	37	14	350
803202	5	-3	3/16	1/4	13,5	37	19	350
803203	6	-4	1/4	1/8	13,5	37	14	350
803204	6	-4	1/4	1/4	14	37,5	19	350
803205	6	-4	1/4	3/8	17,5	40,5	22	350
803206	8	-5	5/16	1/4	16,5	45	19	350
803207	8	-5	5/16	3/8	19	47,5	22	350
803208	10	-6	3/8	1/4	17,5	50	19	350
803209	10	-6	3/8	3/8	19	51,5	22	350
803210	10	-6	3/8	1/2	21	53,5	27	315
803211	12	-8	1/2	3/8	20,5	60,5	22	350
803212	12	-8	1/2	1/2	21	61	27	315
803213	12	-8	1/2	5/8	22	62,5	30	315
803214	12	-8	1/2	3/4	25,5	65,5	32	250
803215	16	-10	5/8	5/8	22	66	30	315
803216	16	-10	5/8	3/4	25	69	32	250
803217	19	-12	3/4	3/4	26	81	32	250
803218	19	-12	3/4	1	28,5	83,5	41	200
803219	25	-16	1	1	29	99,5	41	200

Notes: If you wish to order a fitting in stainless steel, please change the first two digit from **80....** to **81....** .

45° ELBOW THURST-WIRE/SLIP-ON NUT - 60° CONE WITH O-RING - ISO 8434-6 (BS 5200)

Thread BSP Parallel

Code: **8033..**
Type: **DKOR45**

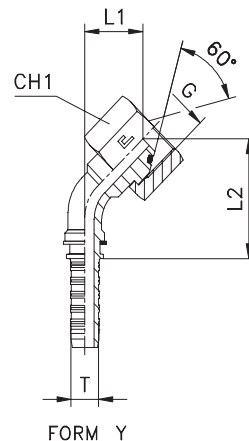
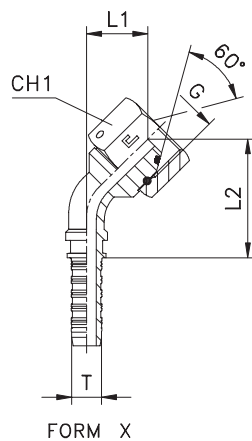

CODE	I.D. hose T			G	FORM	L1	L2	CH1	PN [bar]
	DN	size	INCH						
803301	5	-3	3/16	1/8	X	14,5	39	14	400
803302	5	-3	3/16	1/4	X	16,5	41	19	400
803303	6	-4	1/4	1/8	X	14,5	39	14	400
803304	6	-4	1/4	1/4	X	16,5	41	19	400
803305	6	-4	1/4	3/8	X	18	42,5	22	400
803306	8	-5	5/16	1/4	X	19,5	48,5	19	350
803307	8	-5	5/16	3/8	X	20	49,5	22	350
803308	10	-6	3/8	1/4	X	21,5	55	19	400
803309	10	-6	3/8	3/8	X	20,5	54	22	400
803310	10	-6	3/8	1/2	X	24	57,5	27	350
803311	12	-8	1/2	3/8	X	23	64	22	400
803312	12	-8	1/2	1/2	X	23,5	64,5	27	350
803313	12	-8	1/2	5/8	X	24,5	65,5	30	350
803314	12	-8	1/2	3/4	X	25,5	66,5	32	315
803315	16	-10	5/8	5/8	X	25	70,5	30	350
803316	16	-10	5/8	3/4	X	26,5	72	32	315
803317	19	-12	3/4	3/4	X	27,5	83	32	315
803318	19	-12	3/4	1	X	34	89,5	41	250
803319	25	-16	1	1	X	34,5	107	41	250
803320	25	-16	1	1 1/4	X	39	111,5	50	200
803321	31	-20	1 1/4	1 1/4	X	43	130	50	200
803322	31	-20	1 1/4	1 1/2	X	46,5	134	55	160
803323	38	-24	1 1/2	1 1/2	X	50	164,5	55	160
803324	38	-24	1 1/2	2	X	55	169,5	70	125
803325	51	-32	2	2	X	57,5	212,5	70	125
803326	6	-4	1/4	1/2	X	22	46,5	27	350
803327	8	-5	5/16	1/2	X	23,5	53	27	350
803352	5	-3	3/16	1/4	Y	17	46,5	19	400
803354	6	-4	1/4	1/4	Y	17	46,5	19	400
803355	6	-4	1/4	3/8	Y	18	48	22	400
803357	8	-5	5/16	3/8	Y	18	49	22	350
803359	10	-6	3/8	3/8	Y	18,5	54,5	22	400
803360	10	-6	3/8	1/2	Y	22	58	27	350
803362	12	-8	1/2	1/2	Y	22	62,5	27	350
803363	12	-8	1/2	5/8	Y	22	62,5	30	350
803364	12	-8	1/2	3/4	Y	23,5	63,5	32	315
803366	16	-10	5/8	3/4	Y	23	69	32	315
803368	19	-12	3/4	1	Y	30,5	87	41	250
803370	25	-16	1	1 1/4	Y	36,5	109	50	200
803371	31	-20	1 1/4	1 1/4	Y	39	126	50	200
803372	31	-20	1 1/4	1 1/2	Y	43	130	55	160
803373	38	-24	1 1/2	1 1/2	Y	46	160,5	55	160
803374	38	-24	1 1/2	2	Y	50,5	165	70	125
803376	6	-4	1/4	1/2	Y	22	51,5	27	350
803377	8	-5	5/16	1/2	Y	21,5	52,5	27	350

Notes: If you wish to order a fitting in stainless steel, please change the first two digit from **80....** to **81....** .

STRAIGHT - 60° CONE - ISO 8434-6 (BS 5200)

Metric parallel thread

Code: **8034..**

Type: **AGM**

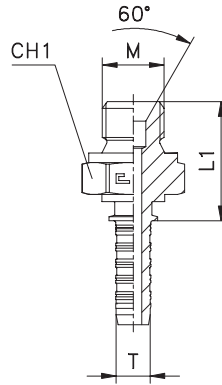

CODE	I.D. hose T			M	L1	CH1	PN [bar]
	DN	size	INCH				
803401	5	-3	3/16	12x1,5	24,5	17	400
803402	6	-4	1/4	12x1,5	24,5	17	400
803403	6	-4	1/4	14x1,5	24,5	19	400
803404	6	-4	1/4	16x1,5	26,5	22	400
803405	6	-4	1/4	18x1,5	27	24	400
803406	8	-5	5/16	14x1,5	25	19	350
803407	8	-5	5/16	16x1,5	27	22	350
803408	8	-5	5/16	18x1,5	27,5	24	350
803409	10	-6	3/8	14x1,5	25	19	400
803410	10	-6	3/8	16x1,5	27	22	400
803411	10	-6	3/8	18x1,5	27,5	24	400
803412	10	-6	3/8	20x1,5	31	27	350
803413	10	-6	3/8	22x1,5	31	27	350
803414	12	-8	1/2	18x1,5	27,5	24	400
803415	12	-8	1/2	20x1,5	31	27	350
803416	12	-8	1/2	22x1,5	31	27	350
803417	12	-8	1/2	26x1,5	34	32	315
803418	16	-10	5/8	26x1,5	34,5	32	315
803419	19	-12	3/4	26x1,5	35	32	315
803420	19	-12	3/4	30x1,5	37	36	250
803421	25	-16	1	38x1,5	37,5	46	200
803422	31	-20	1 1/4	45x1,5	41,5	55	160

Notes: If you wish to order a fitting in stainless steel, please change the first two digit from **80....** to **81....** .

STRAIGHT CRIMPED-BACK NUT - 60° CONE - ISO 8434-6 (BS 5200)

Metric parallel thread

Code: **8035..**

Type: **DKM**

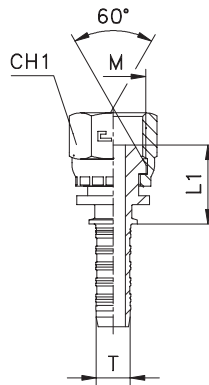

CODE	I.D. hose T			M	L1	CH1	PN [bar]
	DN	size	INCH				
803501	5	-3	3/16	12x1,5	15,5	17	350
803502	6	-4	1/4	12x1,5	15,5	17	350
803503	6	-4	1/4	14x1,5	15,5	19	350
803504	6	-4	1/4	16x1,5	17,5	22	350
803505	6	-4	1/4	18x1,5	17,5	22	350
803506	8	-5	5/16	14x1,5	16	19	350
803507	8	-5	5/16	16x1,5	18	22	350
803508	8	-5	5/16	18x1,5	18	22	350
803509	10	-6	3/8	14x1,5	16	19	350
803510	10	-6	3/8	16x1,5	18	22	350
803511	10	-6	3/8	18x1,5	18	22	350
803512	10	-6	3/8	20x1,5	19	27	315
803513	10	-6	3/8	22x1,5	19	27	315
803514	12	-8	1/2	18x1,5	18	22	315
803515	12	-8	1/2	20x1,5	19	27	315
803516	12	-8	1/2	22x1,5	19	27	315
803517	12	-8	1/2	26x1,5	21,5	32	250
803518	16	-10	5/8	26x1,5	22	32	250
803519	19	-12	3/4	26x1,5	22,5	32	250

Notes: If you wish to order a fitting in stainless steel, please change the first two digit from **80....** to **81....** .

STRAIGHT THURST-WIRE/SLIP-ON NUT - 60° CONE WITH O-RING - ISO 8434-6 (BS 5200)

Metric parallel thread

Code: **8036..**
Type: **DKOM**

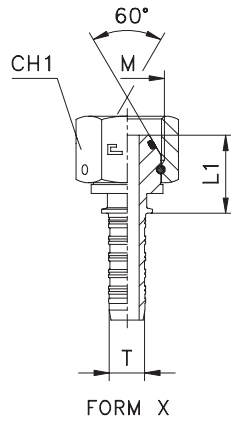

FORM X

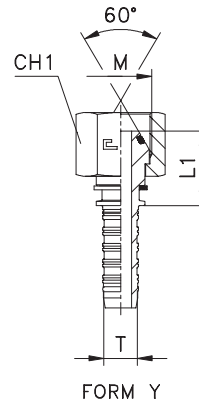

FORM Y

CODE	I.D. hose T			M	FORM	L1	CH1	PN [bar]
	DN	size	INCH					
803601	5	-3	3/16	12x1,5	X	17	17	400
803602	6	-4	1/4	12x1,5	X	17	17	400
803603	6	-4	1/4	14x1,5	X	19	19	400
803604	6	-4	1/4	16x1,5	X	19	22	400
803605	6	-4	1/4	18x1,5	X	20	24	400
803606	8	-5	5/16	14x1,5	X	19,5	19	350
803607	8	-5	5/16	16x1,5	X	19,5	22	350
803608	8	-5	5/16	18x1,5	X	20,5	24	350
803609	10	-6	3/8	14x1,5	X	19,5	19	400
803610	10	-6	3/8	16x1,5	X	19,5	22	400
803611	10	-6	3/8	18x1,5	X	20,5	24	400
803612	10	-6	3/8	20x1,5	X	22,5	27	350
803613	10	-6	3/8	22x1,5	X	22,5	27	350
803614	12	-8	1/2	18x1,5	X	20,5	24	400
803615	12	-8	1/2	20x1,5	X	22,5	27	350
803616	12	-8	1/2	22x1,5	X	22,5	27	350
803617	12	-8	1/2	26x1,5	X	23	32	315
803618	16	-10	5/8	26x1,5	X	23,5	32	315
803619	19	-12	3/4	26x1,5	X	24	32	315
803620	19	-12	3/4	30x1,5	X	26	36	250
803621	25	-16	1	38x1,5	X	31	46	200
803622	31	-20	1 1/4	45x1,5	X	34	55	160
803651	5	-3	3/16	12x1,5	Y	18	17	400
803653	6	-4	1/4	14x1,5	Y	20	19	400
803654	6	-4	1/4	16x1,5	Y	20	22	400
803655	6	-4	1/4	18x1,5	Y	21	24	400
803657	8	-5	5/16	16x1,5	Y	20,5	22	350
803658	8	-5	5/16	18x1,5	Y	21,5	24	350
803661	10	-6	3/8	18x1,5	Y	21,5	24	400
803662	10	-6	3/8	20x1,5	Y	23,5	27	350
803663	10	-6	3/8	22x1,5	Y	23,5	27	350
803666	12	-8	1/2	22x1,5	Y	23,5	27	350
803667	12	-8	1/2	26x1,5	Y	24	32	315
803668	16	-10	5/8	26x1,5	Y	24,5	32	315
803670	19	-12	3/4	30x1,5	Y	27	36	250
803671	25	-16	1	38x1,5	Y	32	46	200
803672	31	-20	1 1/4	45x1,5	Y	35	55	160

Notes: If you wish to order a fitting in stainless steel, please change the first two digit from 80.... to 81....

90° ELBOW CRIMPED-BACK NUT - 60° CONE - ISO 8434-6 (BS 5200)

Metric parallel thread

Code: **8037..**
Type: **DKM90**

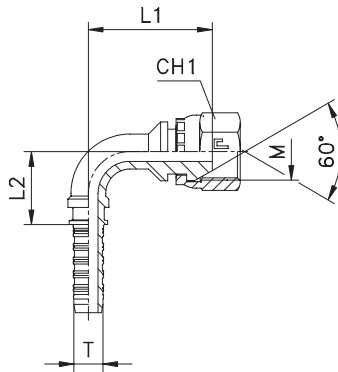

CODE	I.D. hose T			M	L1	L2	CH1	PN [bar]
	DN	size	INCH					
803701	5	-3	3/16	12x1,5	26,5	21	17	350
803702	6	-4	1/4	12x1,5	26,5	21	17	350
803703	6	-4	1/4	14x1,5	26,5	21	19	350
803704	6	-4	1/4	16x1,5	30,5	21	22	350
803705	6	-4	1/4	18x1,5	30,5	21	22	350
803706	8	-5	5/16	14x1,5	32	25,5	19	350
803707	8	-5	5/16	16x1,5	35	25,5	22	350
803708	8	-5	5/16	18x1,5	35	25,5	22	350
803709	10	-6	3/8	14x1,5	34,5	29	19	350
803710	10	-6	3/8	16x1,5	36,5	29	22	350
803711	10	-6	3/8	18x1,5	36,5	29	22	350
803712	10	-6	3/8	20x1,5	39,5	29	27	315
803713	10	-6	3/8	22x1,5	39,5	29	27	315
803714	12	-8	1/2	18x1,5	40,5	35,5	22	315
803715	12	-8	1/2	20x1,5	41,5	35,5	27	315
803716	12	-8	1/2	22x1,5	41,5	35,5	27	315
803717	12	-8	1/2	26x1,5	47,5	35,5	32	250
803718	16	-10	5/8	26x1,5	49	39,5	32	250
803719	19	-12	3/4	26x1,5	52,5	49,5	32	250

Notes: If you wish to order a fitting in stainless steel, please change the first two digit from **80....** to **81....** .

45° ELBOW THURST-WIRE/SLIP-ON NUT - 60° CONE WITH O-RING - ISO 8434-6 (BS 5200)

Metric parallel thread

Code: **8038..**
Type: **DKOM90**

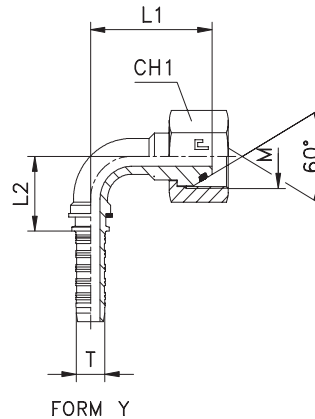
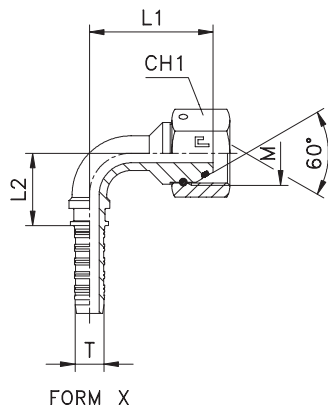

CODE	I.D. hose T			M	FORM	L1	L2	CH1	PN [bar]
	DN	size	INCH						
803801	5	-3	3/16	12x1,5	X	28	21,5	17	400
803802	6	-4	1/4	12x1,5	X	28	21,5	17	400
803803	6	-4	1/4	14x1,5	X	31	21,5	19	400
803804	6	-4	1/4	16x1,5	X	32	21,5	22	400
803805	6	-4	1/4	18x1,5	X	34	21,5	24	400
803806	8	-5	5/16	14x1,5	X	36	26	19	350
803807	8	-5	5/16	16x1,5	X	37	26	22	350
803808	8	-5	5/16	18x1,5	X	39	26	24	350
803809	10	-6	3/8	14x1,5	X	40	29,5	19	400
803810	10	-6	3/8	16x1,5	X	38,5	29,5	22	400
803811	10	-6	3/8	18x1,5	X	40,5	29,5	24	400
803812	10	-6	3/8	20x1,5	X	43,5	29,5	27	350
803813	10	-6	3/8	22x1,5	X	44,5	29,5	27	350
803814	12	-8	1/2	18x1,5	X	45	36	24	400
803815	12	-8	1/2	20x1,5	X	45	36	27	350
803816	12	-8	1/2	22x1,5	X	46	36	27	350
803817	12	-8	1/2	26x1,5	X	48,5	36	32	315
803818	16	-10	5/8	26x1,5	X	51,5	40	32	315
803819	19	-12	3/4	26x1,5	X	55,5	50	32	315
803820	19	-12	3/4	30x1,5	X	60,5	50	36	250
803821	25	-16	1	38x1,5	X	74	63	46	200
803822	31	-20	1 1/4	45x1,5	X	93	75,5	55	160
803851	5	-3	3/16	12x1,5	Y	31	25,5	17	400
803853	6	-4	1/4	14x1,5	Y	33	26	19	400
803854	6	-4	1/4	16x1,5	Y	34,5	26	22	400
803855	6	-4	1/4	18x1,5	Y	36	26	24	400
803857	8	-5	5/16	16x1,5	Y	35	27,5	22	350
803858	8	-5	5/16	18x1,5	Y	36,5	27,5	24	350
803861	10	-6	3/8	18x1,5	Y	38	32	24	400
803862	10	-6	3/8	20x1,5	Y	40	32	27	350
803863	10	-6	3/8	22x1,5	Y	42	32	27	350
803866	12	-8	1/2	22x1,5	Y	42,5	35,5	27	350
803867	12	-8	1/2	26x1,5	Y	44,5	35,5	32	315
803868	16	-10	5/8	26x1,5	Y	46,5	40	32	315
803870	19	-12	3/4	30x1,5	Y	54,5	50,5	36	250
803871	25	-16	1	38x1,5	Y	68	63	46	200
803872	31	-20	1 1/4	45x1,5	Y	85	75,5	55	160

Notes: If you wish to order a fitting in stainless steel, please change the first two digit from **80....** to **81....** .

90° COMPACT ELBOW THURST-WIRE NUT - 60° CONE WITH O-RING - ISO 8434-6 (BS 5200)

Metric parallel thread

Code: **8039..**
Type: **DKOM90-K**

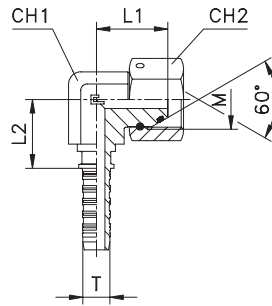

CODE	I.D. hose T			M	L1	L2	CH1	CH2	PN [bar]
	DN	size	INCH						
803901	5	-3	3/16	12x1,5	22	16,5	11	17	400
803902	6	-4	1/4	14x1,5	28,5	18,5	14	19	400
803903	8	-5	5/16	16x1,5	32	22,5	19	22	350
803904	10	-6	3/8	18x1,5	33	23	19	24	400
803905	12	-8	1/2	22x1,5	37	25,5	22	27	350
803906	16	-10	5/8	26x1,5	44,5	29	27	32	315
803907	19	-12	3/4	26x1,5	43	32,5	27	32	315
803908	25	-16	1	38x1,5	54	43	41	46	200

Notes: If you wish to order a fitting in stainless steel, please change the first two digit from **80....** to **81....** .

45° ELBOW CRIMPED-BACK NUT - 60° CONE - ISO 8434-6 (BS 5200)

Metric parallel thread

Code: **8040..**
Type: **DKM45**

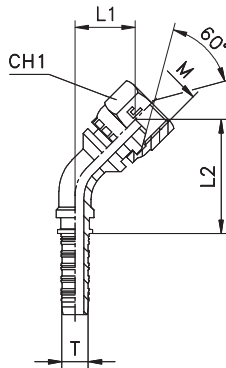

CODE	I.D. hose T			M	L1	L2	CH1	PN [bar]
	DN	size	INCH					
804001	5	-3	3/16	12x1,5	13,5	37	17	350
804002	6	-4	1/4	12x1,5	13,5	37	17	350
804003	6	-4	1/4	14x1,5	14	37,5	19	350
804004	6	-4	1/4	16x1,5	17,5	40,5	22	350
804005	6	-4	1/4	18x1,5	17,5	40,5	22	350
804006	8	-5	5/16	14x1,5	16,5	45	19	350
804007	8	-5	5/16	16x1,5	19	47,5	22	350
804008	8	-5	5/16	18x1,5	19	47,5	22	350
804009	10	-6	3/8	14x1,5	17,5	50	19	350
804010	10	-6	3/8	16x1,5	19	51,5	22	350
804011	10	-6	3/8	18x1,5	19	51,5	22	350
804012	10	-6	3/8	20x1,5	21	53,5	27	315
804013	10	-6	3/8	22x1,5	21	53,5	27	315
804014	12	-8	1/2	18x1,5	20,5	60,5	22	315
804015	12	-8	1/2	20x1,5	21	61	27	315
804016	12	-8	1/2	22x1,5	21	61	27	315
804017	12	-8	1/2	26x1,5	25,5	65,5	32	250
804018	16	-10	5/8	26x1,5	25	69	32	250
804019	19	-12	3/4	26x1,5	26	81	32	250

Notes: If you wish to order a fitting in stainless steel, please change the first two digit from **80....** to **81....** .

45° ELBOW THURST-WIRE/SLIP-ON NUT - 60° CONE WITH O-RING - ISO 8434-6 (BS 5200)

Metric parallel thread

Code: **8041..**
Type: **DKOM45**

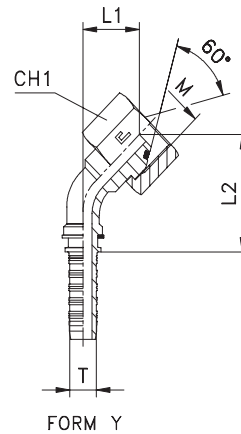
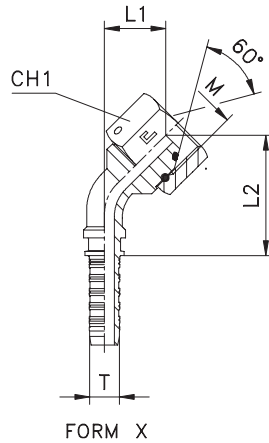

CODE	I.D. hose T			M	FORM	L1	L2	CH1	PN [bar]
	DN	size	INCH						
804101	5	-3	3/16	12x1,5	X	15	39,5	17	400
804102	6	-4	1/4	12x1,5	X	15	39,5	17	400
804103	6	-4	1/4	14x1,5	X	17,5	42	19	400
804104	6	-4	1/4	16x1,5	X	18	42,5	22	400
804105	6	-4	1/4	18x1,5	X	19,5	44	24	400
804106	8	-5	5/16	14x1,5	X	19,5	48,5	19	350
804107	8	-5	5/16	16x1,5	X	20	49,5	22	350
804108	8	-5	5/16	18x1,5	X	21,5	50,5	24	350
804109	10	-6	3/8	14x1,5	X	21,5	55	19	400
804110	10	-6	3/8	16x1,5	X	20,5	54	22	400
804111	10	-6	3/8	18x1,5	X	22	55	24	400
804112	10	-6	3/8	20x1,5	X	24	57,5	27	350
804113	10	-6	3/8	22x1,5	X	24,5	58	27	350
804114	12	-8	1/2	18x1,5	X	23,5	64,5	24	400
804115	12	-8	1/2	20x1,5	X	23,5	64,5	27	350
804116	12	-8	1/2	22x1,5	X	24	65,5	27	350
804117	12	-8	1/2	26x1,5	X	26	67	32	315
804118	16	-10	5/8	26x1,5	X	26,5	72,5	32	315
804119	19	-12	3/4	26x1,5	X	28	84,5	32	315
804120	19	-12	3/4	30x1,5	X	31,5	88	36	250
804121	25	-16	1	38x1,5	X	37,5	110	46	200
804122	31	-20	1 1/4	45x1,5	X	46	133	55	160
804151	5	-3	3/16	12x1,5	Y	15	44,5	17	400
804153	6	-4	1/4	14x1,5	Y	17	46,5	19	400
804154	6	-4	1/4	16x1,5	Y	18	48	22	400
804155	6	-4	1/4	18x1,5	Y	19	49	24	400
804157	8	-5	5/16	16x1,5	Y	18	49	22	350
804158	8	-5	5/16	18x1,5	Y	19	50	24	350
804161	10	-6	3/8	18x1,5	Y	19,5	55,5	24	400
804162	10	-6	3/8	20x1,5	Y	21	56,5	27	350
804163	10	-6	3/8	22x1,5	Y	22	58	27	350
804166	12	-8	1/2	22x1,5	Y	22	62,5	27	350
804167	12	-8	1/2	26x1,5	Y	23,5	63,5	32	315
804168	16	-10	5/8	26x1,5	Y	23	69	32	315
804170	19	-12	3/4	30x1,5	Y	29,5	84	36	250
804171	25	-16	1	38x1,5	Y	33	106	46	200
804172	31	-20	1 1/4	45x1,5	Y	40,5	127,5	55	160

Notes: If you wish to order a fitting in stainless steel, please change the first two digit from **80....** to **81....** .

STRAIGHT ORFS - ISO 8434-3 (SAE J1453)

Thread UNF/UNS/UN-2A

Code: **8042..**
Type: **AGO**

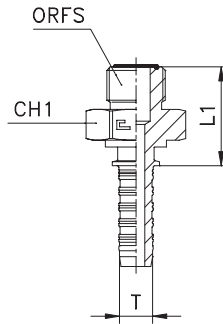

CODE	I.D. hose T			Pipe Ø ORFS		ORFS	L1	CH1	PN [bar]
	DN	size	INCH	M	W				
804201	6	-4	1/4	6	1/4	9/16-18	24,5	17	450
804202	6	-4	1/4	8-10	5/16-3/8	11/16-16	27	19	450
804203	8	-5	5/16	8-10	5/16-3/8	11/16-16	27,5	19	350
804204	10	-6	3/8	8-10	5/16-3/8	11/16-16	27,5	19	445
804205	10	-6	3/8	12	1/2	13/16-16	30	22	445
804206	12	-8	1/2	12	1/2	13/16-16	30	22	415
804207	12	-8	1/2	14-15-16	5/8	1-14	34,5	27	415
804208	12	-8	1/2	18-20	3/4	13/16-12	37,5	32	415
804209	16	-10	5/8	14-15-16	5/8	1-14	35	27	350
804210	16	-10	5/8	18-20	3/4	13/16-12	38	32	350
804211	19	-12	3/4	18-20	3/4	13/16-12	38,5	32	350
804212	19	-12	3/4	22-25	7/8-1	17/16-12	40,5	41	350
804213	25	-16	1	22-25	7/8-1	17/16-12	42	41	280
804214	31	-20	1 1/4	28-30-32	1 1/4	11/16-12	45	46	210
804215	38	-24	1 1/2	35-38	1 1/2	2-12	47,5	55	185

Notes: If you wish to order a fitting in stainless steel, please change the first two digit from **80....** to **81....** .

STRAIGHT ORFS CRIMPED-BACK/SLIP-ON NUT - ISO 8434-3 (SAE J1453)

Thread UNF/UNS/UN-2B

Code: **8043..**
Type: **ORFS**

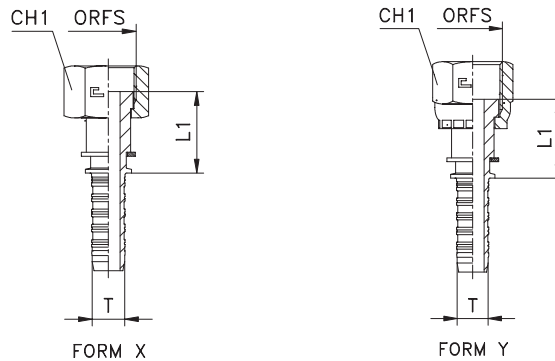

CODE	I.D. hose T			Pipe Ø ORFS		ORFS	FORM	L1	CH1	PN [bar]
	DN	size	INCH	M	W					
804301	6	-4	1/4	6	1/4	9/16-18	X	21	17	450
804302	6	-4	1/4	8-10	5/16-3/8	11/16-16	X	23	22	450
804303	8	-5	5/16	8-10	5/16-3/8	11/16-16	X	23,5	22	350
804304	10	-6	3/8	8-10	5/16-3/8	11/16-16	X	23,5	22	445
804305	10	-6	3/8	12	1/2	13/16-16	X	26,5	24	445
804306	12	-8	1/2	12	1/2	13/16-16	Y	26,5	24	415
804307	12	-8	1/2	14-15-16	5/8	1-14	X	30,5	30	415
804308	12	-8	1/2	18-20	3/4	13/16-12	X	33	36	415
804309	16	-10	5/8	14-15-16	5/8	1-14	X	31	30	350
804310	16	-10	5/8	18-20	3/4	13/16-12	X	33,5	36	350
804311	19	-12	3/4	18-20	3/4	13/16-12	X	34	36	350
804312	19	-12	3/4	22-25	7/8-1	17/16-12	X	35	41	350
804313	25	-16	1	22-25	7/8-1	17/16-12	Y	35,5	46	280
804314	31	-20	1 1/4	28-30-32	1 1/4	11/16-12	Y	36,5	50	210
804315	38	-24	1 1/2	35-38	1 1/2	2-12	X	37,5	60	185

Notes: If you wish to order a fitting in stainless steel, please change the first two digit from **80....** to **81....** .

90° ELBOW ORFS CRIMPED-BACK/SLIP-ON NUT - ISO 8434-3 (SAE J1453)

Thread UNF/UNS/UN-2B

Code: **8044..**
Type: **ORFS90**

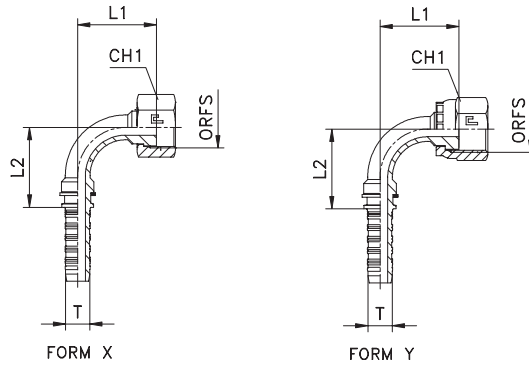

CODE	I.D. hose T			Pipe Ø ORFS		ORFS	FORM	L1	L2	CH1	PN [bar]
	DN	size	INCH	M	W						
804401	6	-4	1/4	6	1/4	9/16-18	X	26,5	26	17	450
804402	6	-4	1/4	8-10	5/16-3/8	11/16-16	X	29,5	26	22	450
804403	8	-5	5/16	8-10	5/16-3/8	11/16-16	X	30	27,5	22	350
804404	10	-6	3/8	8-10	5/16-3/8	11/16-16	X	31,5	32	22	445
804405	10	-6	3/8	12	1/2	13/16-16	X	34,5	32	24	445
804406	12	-8	1/2	12	1/2	13/16-16	Y	35	35,5	24	415
804407	12	-8	1/2	14-15-16	5/8	1-14	X	39	35,5	30	415
804408	12	-8	1/2	18-20	3/4	13/16-12	X	42	35,5	36	415
804409	16	-10	5/8	14-15-16	5/8	1-14	X	41	40	30	350
804410	16	-10	5/8	18-20	3/4	13/16-12	X	44	40	36	350
804411	19	-12	3/4	18-20	3/4	13/16-12	X	48	50,5	36	350
804412	19	-12	3/4	22-25	7/8-1	17/16-12	X	51,5	50,5	41	350
804413	25	-16	1	22-25	7/8-1	17/16-12	Y	57,5	63	46	280
804414	31	-20	1 1/4	28-30-32	1 1/4	11/16-12	Y	72	75,5	50	210
804415	38	-24	1 1/2	35-38	1 1/2	2-12	X	87	101	60	185

Notes: If you wish to order a fitting in stainless steel, please change the first two digit from **80....** to **81....** .

45° ELBOW ORFS CRIMPED-BACK/SLIP-ON NUT - ISO 8434-3 (SAE J1453)

Thread UNF/UNS/UN-2B

Code: **8045..**
Type: **ORFS45**

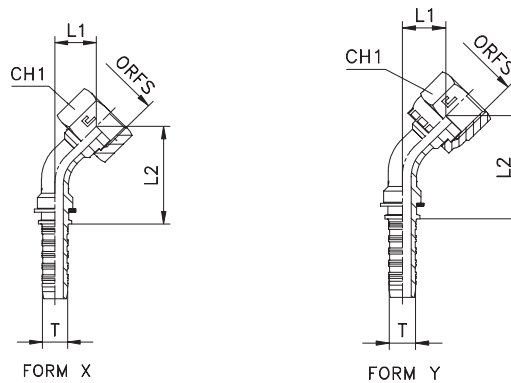

CODE	I.D. hose T			Pipe Ø ORFS		ORFS	FORM	L1	L2	CH1	PN [bar]
	DN	size	INCH	M	W						
804501	6	-4	1/4	6	1/4	9/16-18	X	12	42	17	450
804502	6	-4	1/4	8-10	5/16-3/8	11/16-16	X	14,5	44,5	22	450
804503	8	-5	5/16	8-10	5/16-3/8	11/16-16	X	14	45,5	22	350
804504	10	-6	3/8	8-10	5/16-3/8	11/16-16	X	15	50,5	22	445
804505	10	-6	3/8	12	1/2	13/16-16	X	17	53	24	445
804506	12	-8	1/2	12	1/2	13/16-16	Y	16,5	57	24	415
804507	12	-8	1/2	14-15-16	5/8	1-14	X	19,5	60	30	415
804508	12	-8	1/2	18-20	3/4	13/16-12	X	21,5	62	36	415
804509	16	-10	5/8	14-15-16	5/8	1-14	X	19,5	65	30	350
804510	16	-10	5/8	18-20	3/4	13/16-12	X	21,5	67	36	350
804511	19	-12	3/4	18-20	3/4	13/16-12	X	22,5	80	36	350
804512	19	-12	3/4	22-25	7/8-1	17/16-12	X	25	82,5	41	350
804513	25	-16	1	22-25	7/8-1	17/16-12	Y	26	98,5	46	280
804514	31	-20	1 1/4	28-30-32	1 1/4	11/16-12	Y	31	118	50	210
804515	38	-24	1 1/2	35-38	1 1/2	2-12	X	37,5	152	60	185

Notes: If you wish to order a fitting in stainless steel, please change the first two digit from **80....** to **81....** .

BSP BANJO

Code: **8046..**
Type: **RNR**

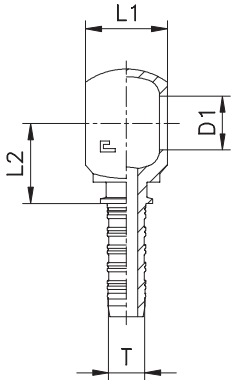

METRIC BANJO

Code: **8047..**
Type: **RNM**

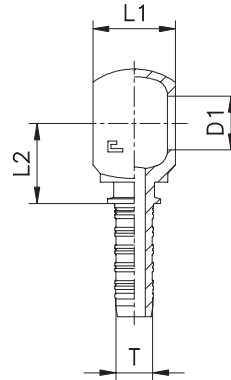

CODE	I.D. hose T			G (perford bolt)	D1	L1	L2
	DN	size	INCH				
804601	5	-3	3/16	1/8	10,1	10	20
804602	5	-3	3/16	1/4	13,3	14	23
804603	6	-4	1/4	1/8	10,1	10	22
804604	6	-4	1/4	1/4	13,3	14	23
804605	6	-4	1/4	3/8	16,8	17	25
804606	6	-4	1/4	1/2	21	22	27,5
804607	8	-5	5/16	1/4	13,3	14	26,5
804608	8	-5	5/16	3/8	16,8	17	26
804609	8	-5	5/16	1/2	21	22	28
804610	10	-6	3/8	1/4	13,3	14	26,5
804611	10	-6	3/8	3/8	16,8	17	25,5
804612	10	-6	3/8	1/2	21	22	28
804613	12	-8	1/2	3/8	16,8	17	28,5
804614	12	-8	1/2	1/2	21	22	28
804615	12	-8	1/2	5/8	23	25	30,5
804616	16	-10	5/8	5/8	23	25	31
804617	16	-10	5/8	3/4	26,5	30	37,5
804618	19	-12	3/4	3/4	26,5	30	38
804619	25	-16	1	1	33,3	37,5	49,5

Notes: If you wish to order a fitting in stainless steel, please change the first two digit from **80....** to **81....** .

CODE	I.D. hose T			M (perford bolt)	D1	L1	L2
	DN	size	INCH				
804601*	5	-3	3/16	10x1	10,1	10	20
804702	5	-3	3/16	12x1,5	12,1	12	21
804703	5	-3	3/16	14x1,5	14,1	14	23
804603*	6	-4	1/4	10x1	10,1	10	22
804705	6	-4	1/4	12x1,5	12,1	12	25
804706	6	-4	1/4	14x1,5	14,1	14	23
804707	6	-4	1/4	16x1,5	16,1	16	25
804708	6	-4	1/4	18x1,5	18,1	20	27
804709	8	-5	5/16	14x1,5	14,1	14	26,5
804710	8	-5	5/16	16x1,5	16,1	16	25,5
804711	8	-5	5/16	18x1,5	18,1	20	27,5
804712	10	-6	3/8	14x1,5	14,1	14	26,5
804713	10	-6	3/8	16x1,5	16,1	16	28,5
804714	10	-6	3/8	18x1,5	18,1	20	27,5
804715	10	-6	3/8	20x1,5	20,1	22	28
804716	10	-6	3/8	22x1,5	22,1	22	28
804717	12	-8	1/2	18x1,5	18,1	20	30,5
804718	12	-8	1/2	20x1,5	20,1	22	28
804719	12	-8	1/2	22x1,5	22,1	22	28
804720	16	-10	5/8	22x1,5	22,1	22	28,5
804618*	19	-12	3/4	26x1,5	26,5	30	38
804722	19	-12	3/4	30x1,5	30,1	36	42,5

Notes: If you wish to order a fitting in stainless steel, please change the first two digit from **80....** to **81....** .
*Order with BSP thread code.

PERFORED BOLT
Thread BSP Parallel

Code: **8048..**
Type: **BFG**

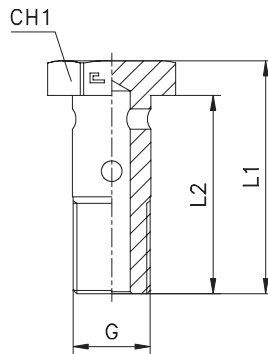

CODE	G	L1	L2	CH1
804801	1/8	26	21	14
804802	1/4	34	28	19
804803	3/8	39	32	22
804804	1/2	48	40	27
804805	5/8	52	43	30
804806	3/4	58	48	32
804807	1	69	58	41

Notes: If you wish to order a fitting in stainless steel, please change the first two digit from **80....** to **81....** .

PERFORED BOLT
Metric parallel thread

Code: **8049..**
Type: **BFM**

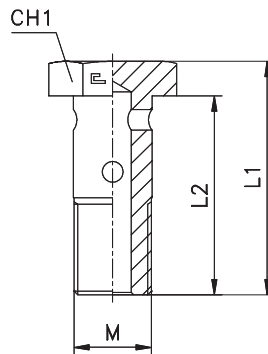

CODE	M	L1	L2	CH1
804901	10x1	26	21	14
804902	12x1,5	31,5	26	17
804903	14x1,5	36	30	19
804904	16x1,5	39	32	22
804905	18x1,5	44	37	24
804906	20x1,5	48	40	27
804907	22x1,5	49	41	27
804908	26x1,5	58	48	32
804909	30x1,5	65	55	36

Notes: If you wish to order a fitting in stainless steel, please change the first two digit from **80....** to **81....** .

SAE WHOLE STRAIGHT FLANGE 3000 PSI SERIES - SAE J518

Code: 8050..
Type: SFL

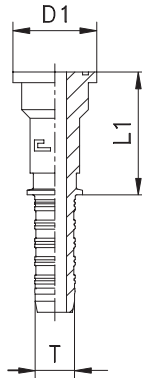

CODE	I.D. hose T			Ø flange	D1	L1	PN [bar]
	DN	size	INCH				
805001	12	-8	1/2	1/2	30	44,5	350
805002	12	-8	1/2	3/4	38	49	350
805003	16	-10	5/8	3/4	38	49,5	350
805004	19	-12	3/4	3/4	38	50	350
805005	19	-12	3/4	1	44,5	53	350
805006	25	-16	1	1	44,5	53,5	280
805007	25	-16	1	1 1/4	50,8	58	280
805008	31	-20	1 1/4	1 1/4	50,8	59	210
805009	31	-20	1 1/4	1 1/2	60,3	61	210
805010	38	-24	1 1/2	1 1/2	60,3	62	185
805011	38	-24	1 1/2	2	71,4	67	185
805012	51	-32	2	2	71,4	68	165

Notes: If you wish to order a fitting in stainless steel, please change the first two digit from 80.... to 81....

SAE WHOLE 90° FLANGE 3000 PSI SERIES - SAE J518

Code: 8051..
Type: SFL90

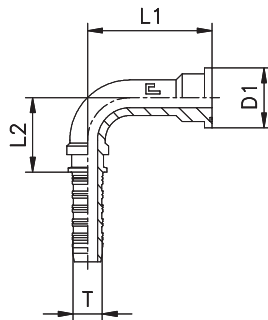

CODE	I.D. hose T			Ø flange	D1	L1	L2	PN [bar]
	DN	size	INCH					
805101	12	-8	1/2	1/2	30	41	36	350
805102	12	-8	1/2	3/4	38	46	36	350
805103	16	-10	5/8	3/4	38	48	40	350
805104	19	-12	3/4	3/4	38	52	53,5	350
805105	19	-12	3/4	1	44,5	55	53,5	350
805106	25	-16	1	1	44,5	61	64,5	280
805107	25	-16	1	1 1/4	50,8	63,5	64,5	280
805108	31	-20	1 1/4	1 1/4	50,8	74,5	75,5	210
805109	31	-20	1 1/4	1 1/2	60,3	80	75,5	210
805110	38	-24	1 1/2	1 1/2	60,3	90,5	101	185
805111	38	-24	1 1/2	2	71,4	96,5	101	185
805112	51	-32	2	2	71,4	112	137,5	165

Notes: If you wish to order a fitting in stainless steel, please change the first two digit from 80.... to 81....

SAE WHOLE 45° FLANGE 3000 PSI SERIES - SAE J518

Code: 8052..
Type: SFL45

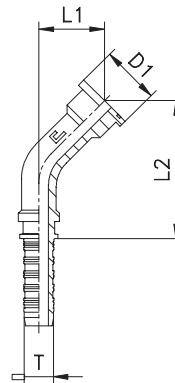

CODE	I.D. hose T			Ø flange	D1	L1	L2	PN [bar]
	DN	size	INCH					
805201	12	-8	1/2	1/2	30	20,5	62	350
805202	12	-8	1/2	3/4	38	24	65,5	350
805203	16	-10	5/8	3/4	38	24	70	350
805204	19	-12	3/4	3/4	38	25	84,5	350
805205	19	-12	3/4	1	44,5	27,5	86,5	350
805206	25	-16	1	1	44,5	28	101	280
805207	25	-16	1	1 1/4	50,8	30	102,5	280
805208	31	-20	1 1/4	1 1/4	50,8	33	120	210
805209	31	-20	1 1/4	1 1/2	60,3	36,5	124	210
805210	38	-24	1 1/2	1 1/2	60,3	40	155	185
805211	38	-24	1 1/2	2	71,4	44,5	159	185
805212	51	-32	2	2	71,4	46,5	202	165

Notes: If you wish to order a fitting in stainless steel, please change the first two digit from 80.... to 81....

SAE WHOLE STRAIGHT FLANGE 6000 PSI SERIES - SAE J518

Code: 8053..
Type: SFS

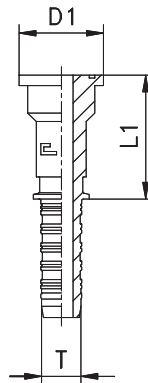

CODE	I.D. hose T			Ø flange	D1	L1	PN [bar]
	DN	size	INCH				
805301	12	-8	1/2	1/2	31,8	45,5	350
805302	12	-8	1/2	3/4	41,3	53	350
805303	16	-10	5/8	3/4	41,3	53,5	350
805304	19	-12	3/4	3/4	41,3	54	350
805305	19	-12	3/4	1	47,6	60	350
805306	25	-16	1	1	47,6	60,5	280
805307	25	-16	1	1 1/4	54	69	280
805308	31	-20	1 1/4	1 1/4	54	70	210
805309	31	-20	1 1/4	1 1/2	63,5	75	210
805310	38	-24	1 1/2	1 1/2	63,5	76	185
805311	38	-24	1 1/2	2	79,4	89	185
805312	51	-32	2	2	79,4	90	165

Notes: If you wish to order a fitting in stainless steel, please change the first two digit from 80.... to 81....

SAE WHOLE 90° FLANGE 6000 PSI SERIES - SAE J518

Code: **8054..**
Type: **SFS90**

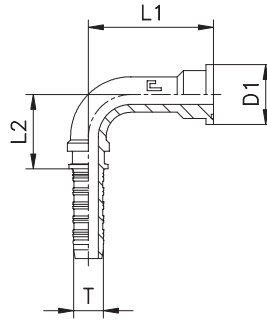

CODE	I.D. hose T			Ø flange	D1	L1	L2	PN [bar]
	DN	size	INCH					
805401	12	-8	1/2	1/2	31,8	42	36	415
805402	12	-8	1/2	3/4	41,3	50	36	415
805403	16	-10	5/8	3/4	41,3	52	40	350
805404	19	-12	3/4	3/4	41,3	56	53,5	350
805405	19	-12	3/4	1	47,6	62	53,5	350
805406	25	-16	1	1	47,6	68	64,5	280
805407	25	-16	1	1 1/4	54	75	64,5	280
805408	31	-20	1 1/4	1 1/4	54	86	75,5	210
805409	31	-20	1 1/4	1 1/2	63,5	94,5	75,5	210
805410	38	-24	1 1/2	1 1/2	63,5	105	101	185
805411	38	-24	1 1/2	2	79,4	121	104	185
805412	51	-32	2	2	79,4	136,5	137,5	165

Notes: If you wish to order a fitting in stainless steel, please change the first two digit from **80....** to **81....** .

SAE WHOLE 45° FLANGE 6000 PSI SERIES - SAE J518

Code: **8055..**
Type: **SFL90**

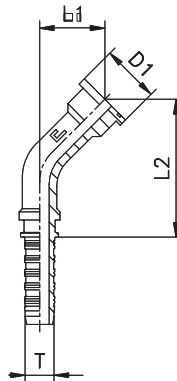

CODE	I.D. hose T			Ø flange	D1	L1	L2	PN [bar]
	DN	size	INCH					
805501	12	-8	1/2	1/2	31,8	21,5	62,5	415
805502	12	-8	1/2	3/4	41,3	27	68	415
805503	16	-10	5/8	3/4	41,3	27	73	350
805504	19	-12	3/4	3/4	41,3	28,5	87,5	350
805505	19	-12	3/4	1	47,6	32,5	91,5	350
805506	25	-16	1	1	47,6	33	106	280
805507	25	-16	1	1 1/4	54	38	111	280
805508	31	-20	1 1/4	1 1/4	54	41	128	210
805509	31	-20	1 1/4	1 1/2	63,5	47	134	210
805510	38	-24	1 1/2	1 1/2	63,5	50,5	165	185
805511	38	-24	1 1/2	2	79,4	61,5	176,5	185
805512	51	-32	2	2	79,4	64	219,5	165

Notes: If you wish to order a fitting in stainless steel, please change the first two digit from **80....** to **81....** .

SAE SPLIT - FLANGE CLAMPS 3000 PSI SERIES - SAE J518

Code: **8056..**
 Type: **FL**

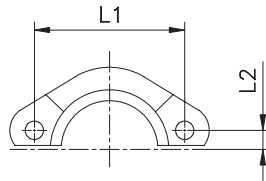

CODE	Ø flange	L1	L2
805601	1/2	38,1	8,7
805602	3/4	47,6	11,1
805603	1	52,4	13,1
805604	1 1/4	58,7	15,1
805605	1 1/2	69,9	17,8
805606	2	77,8	21,4

Notes: If you wish to order a fitting in stainless steel, please change the first two digit from **80....** to **81....** .

SAE SPLIT - FLANGE CLAMPS 6000 PSI SERIES - SAE J518

Code: **8057..**
 Type: **FS**

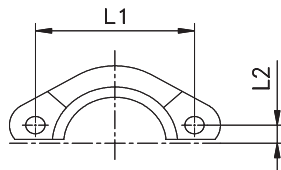

CODE	Ø flange	L1	L2
805701	1/2	40,5	9,1
805702	3/4	50,8	11,9
805703	1	57,2	13,9
805704	1 1/4	66,7	15,9
805705	1 1/2	79,4	18,2
805706	2	96,8	22,2

Notes: If you wish to order a fitting in stainless steel, please change the first two digit from **80....** to **81....** .

FERRULE FOR HOSE 4SH - 4SP - R13- skive

Code: **8058.. INTERLOCK**

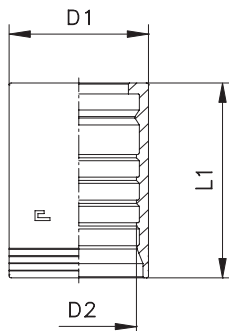

CODE	I.D. hose T		Dimensions [mm]			Skiving length		Applications
	DN	INCH	D1	D2	L1	Esterna	Interna	
805801	19	3/4	38	30	60	48	15	4SH-4SP-R13
805802	25	1	46	37,5	74,5	61	17	4SH-4SP-R13
805803	31	1 1/4	55	43,9	88	70	22	4SH
805804	38	1 1/2	62	51,3	94	79	22,5	4SH
805805	51	2	79,5	66	99	83	30	4SH

Notes: If you wish to order a fitting in stainless steel, please change the first two digit from **80....** to **81....** .

FERRULE FOR HOSE R13 skive

Code: **8059.. INTERLOCK**

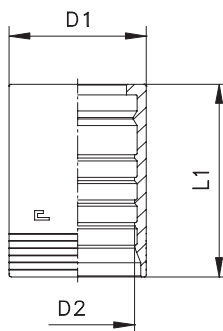

CODE	I.D. hose T		Dimensioni [mm]			Skiving length		Applications
	DN	INCH	D1	D2	L1	Esterna	Interna	
805903	31	1 1/4	60	49,5	88	70	22	R13
805904	38	1 1/2	67	56	94	79	22,5	R13
805905	51	2	84,5	71	99	83	30	R13

Notes: If you wish to order a fitting in stainless steel, please change the first two digit from **80....** to **81....** .

STRAIGHT MALE - CONE 24° - ISO 8434-1 (DIN 2353)

Metric parallel thread

Code: **8060.. INTERLOCK**

Type: **CEL/GES**

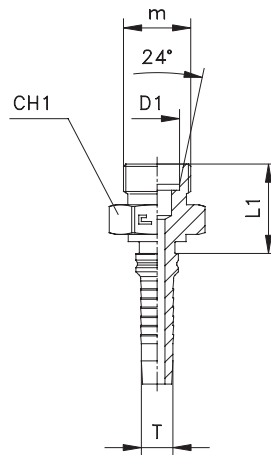

CODE	I.D. hose T			24° cone D1	m	L1	CH1	PN [bar]
	DN	size	INCH					
806001	19	-12	3/4	20S	30x2	34,5	32	400
806002	19	-12	3/4	25S	36x2	38,5	41	400
806003	25	-16	1	25S	36x2	39	41	380
806004	25	-16	1	30S	42x2	41	46	380
806005	31	-20	1 1/4	38S	52x2	48,5	55	315

Notes: If you wish to order a fitting in stainless steel, please change the first two digit from **80....** to **81.....** .

STRAIGHT SLIP-ON NUT - 24° CONE WITH O-RING - ISO 8434-1 (DIN 2353)

Metric parallel thread

Code: **8061.. INTERLOCK**

Type: **DKOS**

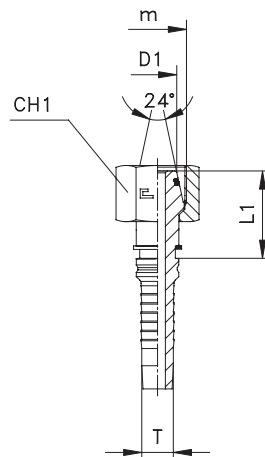

CODE	I.D. hose T			24° cone D1	m	L1	CH1	PN [bar]
	DN	size	INCH					
806101	19	-12	3/4	20S	30x2	34,5	36	400
806102	19	-12	3/4	25S	36x2	36,5	46	400
806103	25	-16	1	25S	36x2	37	46	380
806104	25	-16	1	30S	42x2	40	50	380
806105	31	-20	1 1/4	38S	52x2	45,5	60	315

Notes: If you wish to order a fitting in stainless steel, please change the first two digit from **80....** to **81.....** .

90° ELBOW SLIP-ON NUT - 24° CONE WITH O-RING - ISO 8434-1 (DIN 2353)

Metric parallel thread

Code: **8062.. INTERLOCK**

Type: **DKOS90**

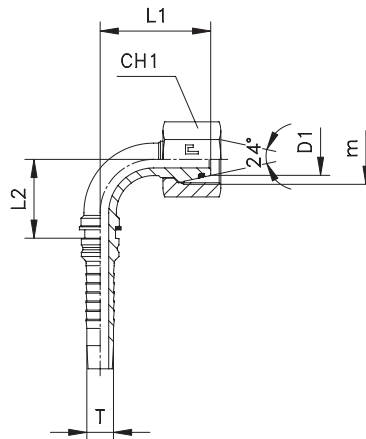

CODE	I.D. hose T			Pipe Ø 24° cone	m	L1	L2	CH1	PN [bar]
	DN	size	INCH						
806201	19	-12	3/4	20S	30x2	53,5	52,5	36	400
806202	19	-12	3/4	25S	36x2	59,5	52,5	46	400
806203	25	-16	1	25S	36x2	65,5	68	46	380
806204	25	-16	1	30S	42x2	72	68	50	380
806205	31	-20	1 1/4	38S	52x2	85	81	60	315

Notes: If you wish to order a fitting in stainless steel, please change the first two digit from **80....** to **81....** .

45° ELBOW SLIP-ON NUT - 24° CONE WITH O-RING - ISO 8434-1 (DIN 2353)

Metric parallel thread

Code: **8063.. INTERLOCK**

Type: **DKOS45**

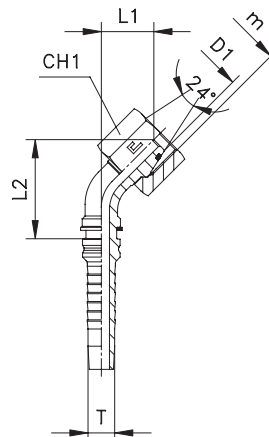

CODE	I.D. hose T			Pipe Ø 24° cone	m	L1	L2	CH1	PN [bar]
	DN	size	INCH						
806301	19	-12	3/4	20S	30x2	26,5	84,5	36	400
806302	19	-12	3/4	25S	36x2	31	88,5	46	400
806303	25	-16	1	25S	36x2	31,5	106,5	46	380
806304	25	-16	1	30S	42x2	36	111	50	380
806305	31	-20	1 1/4	38S	52x2	40,5	131	60	315

Notes: If you wish to order a fitting in stainless steel, please change the first two digit from **80....** to **81....** .

STRAIGHT - JIC 74° CONE - ISO 8434-2 (SAE J514)

UNF/UN-2A thread

Code: **8064.. INTERLOCK**

Type: **AGJ**

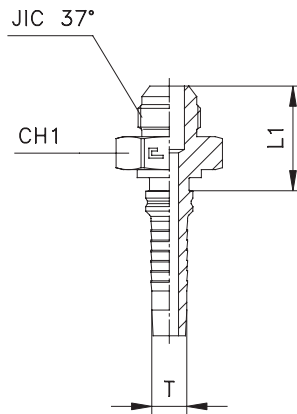

CODE	I.D. hose T			Pipe Ø JIC 37°		JIC 37°	L1	CH1	PN [bar]
	DN	size	INCH	M	W				
806401	19	-12	3/4	18-20	3/4	1 1/16-12	39,5	30	350
806402	19	-12	3/4	22	7/8	1 3/16-12	40	32	290
806403	19	-12	3/4	25	1	1 5/16-12	40,5	36	290
806404	25	-16	1	25	1	1 5/16-12	41	36	290
806405	25	-16	1	30-32	1 1/4	1 5/8-12	44	46	240
806406	31	-20	1 1/4	30-32	1 1/4	1 5/8-12	46,5	46	240
806407	31	-20	1 1/4	38	1 1/2	1 7/8-12	52	50	240
806408	38	-24	1 1/2	38	1 1/2	1 7/8-12	52	50	240
806409	51	-32	2	50	2	2 1/2-12	64,5	65	100

Notes: If you wish to order a fitting in stainless steel, please change the first two digit from **80....** to **81....** .

STRAIGHT THURST-WIRE/SLIP-ON NUT - JIC 74° CONE - ISO 8434-2 (SAE J514)

UNF/UN-2B thread

Code: **8065.. INTERLOCK**

Type: **DKJ**

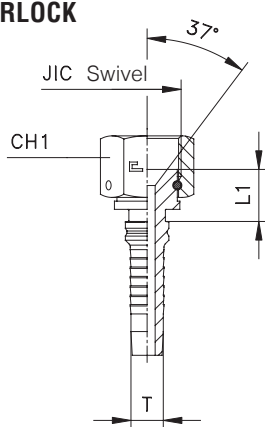

FORM X

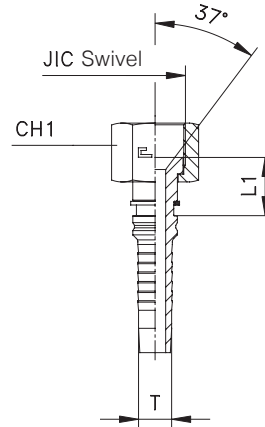

FORM Y

CODICE	I.D. hose T			JIC 37°	FORM	L1	CH1	PN [bar]
	DN	size	INCH					
806501	19	-12	3/4	1 1/16-12	X	18,5	32	350
806502	19	-12	3/4	1 3/16-12	Y	20	36	290
806503	19	-12	3/4	1 5/16-12	Y	20	41	290
806504	25	-16	1	1 5/16-12	X	20,5	41	290
806505	25	-16	1	1 5/8-12	Y	22	50	240
806506	31	-20	1 1/4	1 5/8-12	X	23,5	50	240
806507	31	-20	1 1/4	1 7/8-12	Y	27,5	60	240
806508	38	-24	1 1/2	1 7/8-12	X	27,5	60	240
806509	51	-32	2	2 1/2-12	X	32,5	75	100

Notes: If you wish to order a fitting in stainless steel, please change the first two digit from **80....** to **81....** .

90° ELBOW THURST-WIRE/SLIP-ON NUT - JIC 74° CONE - ISO 8434-2 (SAE J514)
UNF/UN-2B thread BSP taper thread

Code: **8066.. INTERLOCK**
Type: **DKJ90**

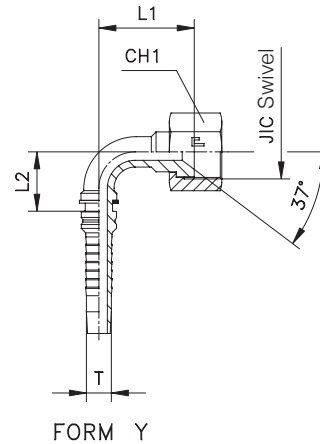
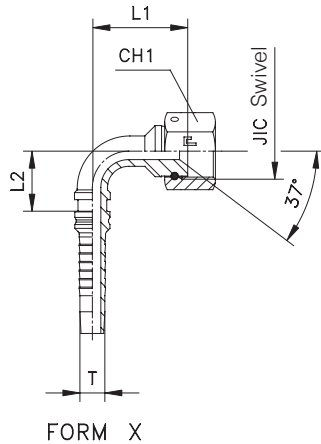

CODE	I.D. hose T			JIC 37°	FORM	L1	L2	CH1	PN [bar]
	DN	size	INCH						
806601	19	-12	3/4	11/16-12	X	51	51,5	32	350
806602	19	-12	3/4	13/16-12	Y	49,5	52,5	36	290
806603	19	-12	3/4	15/16-12	Y	51	52,5	41	290
806604	25	-16	1	15/16-12	X	62,5	69	41	290
806605	25	-16	1	15/8-12	Y	62	67	50	240
806606	31	-20	1 1/4	15/8-12	X	80	81	50	240
806607	31	-20	1 1/4	17/8-12	Y	80	81	60	240
806608	38	-24	1 1/2	17/8-12	X	97,5	105,5	60	240
806609	51	-32	2	2 1/2-12	X	123,5	142,5	75	100

Notes: If you wish to order a fitting in stainless steel, please change the first two digit from **80....** to **81....** .

45° ELBOW THURST-WIRE/SLIP-ON NUT - JIC 74° CONE - ISO 8434-2 (SAE J514)
UNF/UN-2B thread

Code: **8067.. INTERLOCK**
Type: **DKJ45**

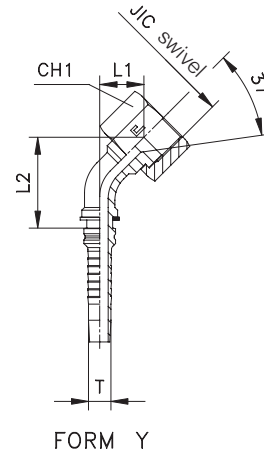
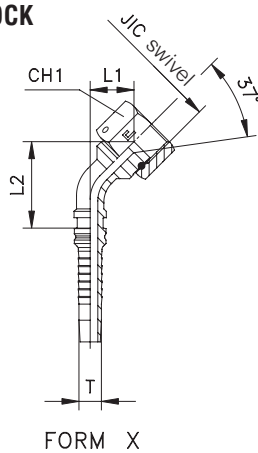

CODE	I.D. hose T			JIC 37°	FORM	L1	L2	CH1	PN [bar]
	DN	size	INCH						
806701	19	-12	3/4	11/16-12	X	25	84,5	32	350
806702	19	-12	3/4	13/16-12	Y	24	82	36	290
806703	19	-12	3/4	15/16-12	Y	25	83	41	290
806704	25	-16	1	15/16-12	X	29,5	104,5	41	290
806705	25	-16	1	15/8-12	Y	29	104	50	240
806706	31	-20	1 1/4	15/8-12	X	36,5	127,5	50	240
806707	31	-20	1 1/4	17/8-12	Y	37	127,5	60	240
806708	38	-24	1 1/2	17/8-12	X	45	162,5	60	240
806709	51	-32	2	2 1/2-12	X	55	213	75	100

Notes: If you wish to order a fitting in stainless steel, please change the first two digit from **80....** to **81....** .

STRAIGHT

BSP taper thread

Code: **8068.. INTERLOCK**

Type: **AGR-K**

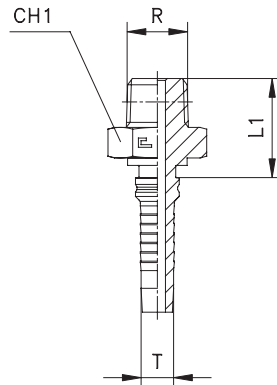

CODE	I.D. hose T			R	L1	CH1	PN [bar]
	DN	size	INCH				
806801	19	-12	3/4	3/4	34,5	27	200
806802	25	-16	1	1	41	36	160
806803	31	-20	1 1/4	1 1/4	46,5	46	160
806804	38	-24	1 1/2	1 1/2	49,5	50	160
806805	51	-32	2	2	55	65	100

Notes: If you wish to order a fitting in stainless steel, please change the first two digit from **80....** to **81....** .

STRAIGHT

Thread NPTF

Code: **8069.. INTERLOCK**

Type: **AGN**

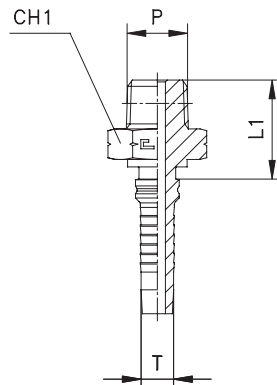

CODE	I.D. hose T			P	L1	CH1	PN [bar]
	DN	size	INCH				
806901	19	-12	3/4	3/4	34,5	27	200
806902	19	-12	3/4	1	40,5	36	160
806903	25	-16	1	1	41	36	160
806904	25	-16	1	1 1/4	44	46	160
806905	31	-20	1 1/4	1 1/4	46,5	46	160
806906	31	-20	1 1/4	1 1/2	49,5	50	160
806907	38	-24	1 1/2	1 1/2	49,5	50	160
806908	51	-32	2	2	55	65	100

Notes: If you wish to order a fitting in stainless steel, please change the first two digit from **80....** to **81....** .

STRAIGHT - 60° CONE - ISO 8434-6 (BS 5200)

Thread BSP Parallel

Code: **8070.. INTERLOCK**

Type: **AGR**

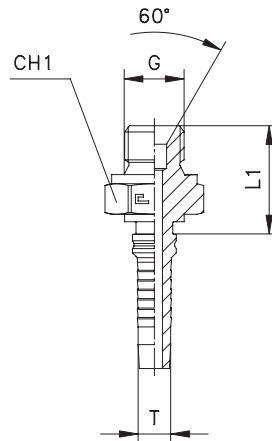

CODE	I.D. hose T			G	L1	CH1	PN [bar]
	DN	size	INCH				
807001	19	-12	3/4	3/4	34,5	32	315
807002	25	-16	1	1	39	41	250
807003	25	-16	1	1 1/4	42	50	200
807004	31	-20	1 1/4	1 1/4	44,5	50	200
807005	38	-24	1 1/2	1 1/2	49,5	55	160
807006	51	-32	2	2	57,5	70	125

Notes: If you wish to order a fitting in stainless steel, please change the first two digit from **80....** to **81....** .

STRAIGHT THURST-WIRE/SLIP-ON NUT - 60° CONE WITH O-RING - ISO 8434-6 (BS 5200)

Thread BSP Parallel

Code: **8071.. INTERLOCK**

Type: **DKOR**

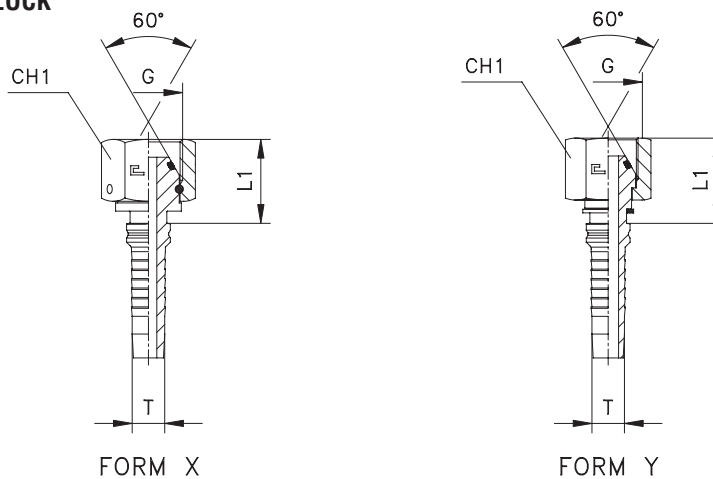

CODE	I.D. hose T			G	FORM	L1	CH1	PN [bar]
	DN	size	INCH					
807101	19	-12	3/4	3/4	X	22,5	32	315
807102	25	-16	1	1	X	28	41	250
807103	25	-16	1	1 1/4	Y	31	50	200
807104	31	-20	1 1/4	1 1/4	Y	32,5	50	200
807105	38	-24	1 1/2	1 1/2	Y	34,5	55	160
807106	51	-32	2	2	X	38	70	125

Notes: If you wish to order a fitting in stainless steel, please change the first two digit from **80....** to **81....** .

90° ELBOW THURST-WIRE/SLIP-ON NUT - 60° CONE WITH O-RING - ISO 8434-6 (BS 5200)

Thread BSP Parallel

Code: **8072.. INTERLOCK**
Type: **DKOR90**

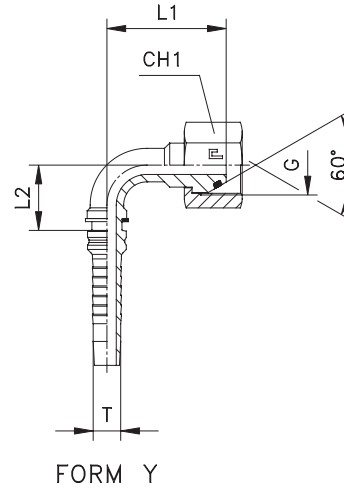
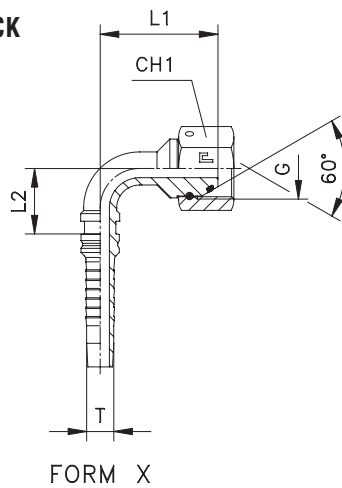

CODE	I.D. hose T			G	FORM	L1	L2	CH1	PN [bar]
	DN	size	INCH						
807201	19	-12	3/4	3/4	X	55	52	32	315
807202	25	-16	1	1	X	70	68	41	250
807203	25	-16	1	1 1/4	Y	72,5	68	50	200
807204	31	-20	1 1/4	1 1/4	Y	83	81	50	200
807205	38	-24	1 1/2	1 1/2	Y	99	105	55	160
807206	51	-32	2	2	X	127	142,5	70	125

Notes: If you wish to order a fitting in stainless steel, please change the first two digit from **80....** to **81....** .

45° ELBOW THURST-WIRE/SLIP-ON NUT - 60° CONE WITH O-RING (BS 5200)

Thread BSP Parallel

Code: **8073.. INTERLOCK**
Type: **DKOR45**

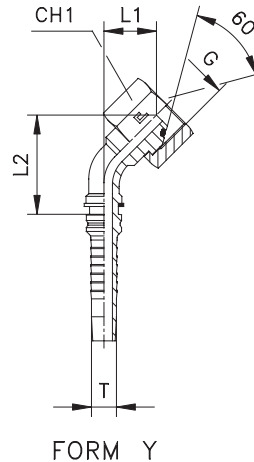
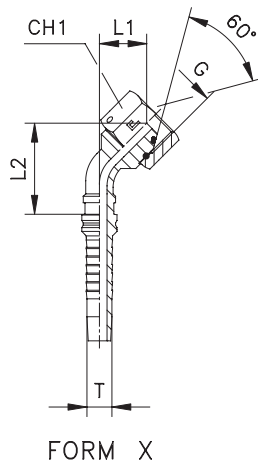

CODE	I.D. hose T			G	FORM	L1	L2	CH1	PN [bar]
	DN	size	INCH						
807301	19	-12	3/4	3/4	X	27,5	83,5	32	315
807302	25	-16	1	1	X	34,5	109,5	41	250
807303	25	-16	1	1 1/4	Y	36,5	111,5	50	200
807304	31	-20	1 1/4	1 1/4	Y	39	129,5	50	200
807305	38	-24	1 1/2	1 1/2	Y	46	163	55	160
807306	51	-32	2	2	X	57,5	215,5	70	125

Notes: If you wish to order a fitting in stainless steel, please change the first two digit from **80....** to **81....** .

STRAIGHT ORFS - ISO 8434-3 (SAE J1453)

Thread UNF/UNS/UN-2A

Code: **8074.. INTERLOCK**

Type: **AGO**

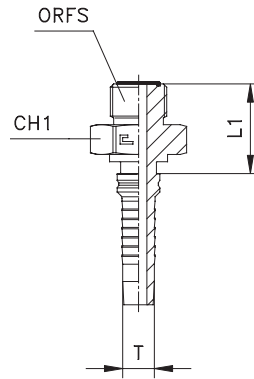

CODE	I.D. hose T			Ø tube ORFS		ORFS	L1	CH1	PN [bar]
	DN	size	INCH	M	W				
807401	19	-12	3/4	18-20	3/4	13/16-12	36,5	32	420
807402	25	-16	1	22-25	7/8-1	17/16-12	39	41	380
807403	31	-20	1 1/4	28-30	1 1/4	1 11/16-12	43,5	46	280
807404	38	-24	1 1/2	35-38	1 1/2	2-12	45	55	280

Notes: If you wish to order a fitting in stainless steel, please change the first two digit from **80....** to **81....** .

STRAIGHT ORFS CRIMPED-BACK/SLIP-ON NUT - ISO 8434-3 (SAE J1453)

Thread UNF/UNS/UN-2B

Code: **8075.. INTERLOCK**

Type: **ORFS**

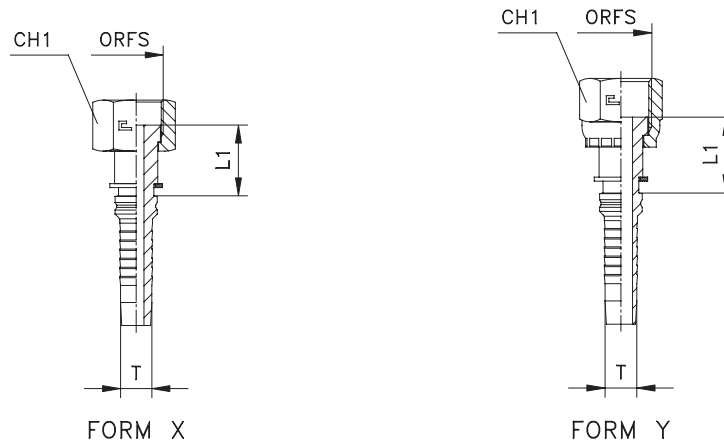

CODE	I.D. hose T			Ø tube ORFS		ORFS	FORM	L1	CH1	PN [bar]
	DN	size	INCH	M	W					
807501	19	-12	3/4	18-20	3/4	13/16-12	X	32	36	420
807502	25	-16	1	22-25	7/8-1	17/16-12	Y	33,5	46	380
807503	31	-20	1 1/4	28-30	1 1/4	1 11/16-12	Y	35	50	280
807504	38	-24	1 1/2	35-38	1 1/2	2-12	X	35	60	280

Notes: If you wish to order a fitting in stainless steel, please change the first two digit from **80....** to **81....** .

90° ELBOW ORFS CRIMPED-BACK/SLIP-ON NUT - ISO 8434-3 (SAE J1453)

Thread UNF/UNS/UN-2B

Code: **8076.. INTERLOCK**
Type: **ORFS90**

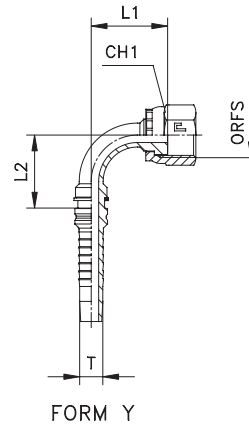
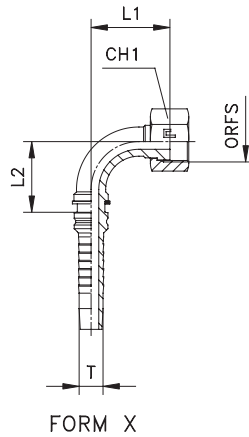

CODE	I.D. hose T			Ø tube ORFS		ORFS	FORM	L1	L2	CH1	PN [bar]
	DN	size	INCH	M	W						
807601	19	-12	3/4	18-20	3/4	13/16-12	X	51	52,5	36	420
807602	25	-16	1	22-25	7/8-1	17/16-12	Y	57,5	68	46	380
807603	31	-20	1 1/4	28-30-32	1 1/4	1 11/16-12	Y	72	81	50	280
807604	38	-24	1 1/2	35-38	1 1/2	2-12	X	87	105,5	60	280

Notes: If you wish to order a fitting in stainless steel, please change the first two digit from **80....** to **81....** .

45° ELBOW ORFS CRIMPED-BACK/SLIP-ON NUT - ISO 8434-3 (SAE J1453)

Thread UNF/UNS/UN-2B

Code: **8077.. INTERLOCK**
Type: **ORFS45**

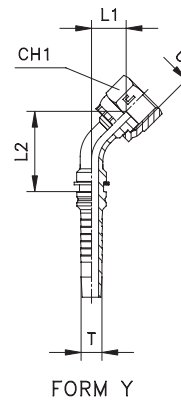
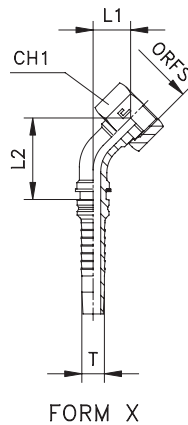

CODE	I.D. hose T			Ø tube ORFS		ORFS	FORM	L1	L2	CH1	PN [bar]
	DN	size	INCH	M	W						
807701	19	-12	3/4	18-20	3/4	13/16-12	X	22,5	80,5	36	420
807702	25	-16	1	22-25	7/8-1	17/16-12	Y	26	101	46	380
807703	31	-20	1 1/4	28-30-32	1 1/4	1 11/16-12	Y	31	121,5	50	280
807704	38	-24	1 1/2	35-38	1 1/2	2-12	X	37,5	154,5	60	280

Notes: If you wish to order a fitting in stainless steel, please change the first two digit from **80....** to **81....** .

SAE WHOLE STRAIGHT FLANGE 3000 PSI SERIES - SAE J518

Code: **8078.. INTERLOCK**
 Type: **SFL**

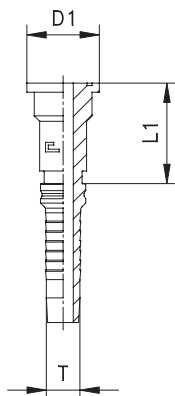

CODE	I.D. hose T			Ø flange	D1	L1	PN [bar]
	DN	size	INCH				
807801	19	-12	3/4	3/4	38	48	350
807802	19	-12	3/4	1	44,5	51	350
807803	25	-16	1	1	44,5	51,5	320
807804	25	-16	1	1 1/4	50,8	56	280
807805	31	-20	1 1/4	1 1/4	50,8	57,5	280
807806	31	-20	1 1/4	1 1/2	60,3	59,5	210
807807	38	-24	1 1/2	1 1/2	60,3	59,5	210
807808	38	-24	1 1/2	2	71,4	64,5	210
807809	51	-32	2	2	71,4	66	210

Notes: If you wish to order a fitting in stainless steel, please change the first two digit from **80....** to **81....** .

SAE WHOLE 90° FLANGE 3000 PSI SERIES - SAE J518

Code: **8079.. INTERLOCK**
 Type: **SFL90**

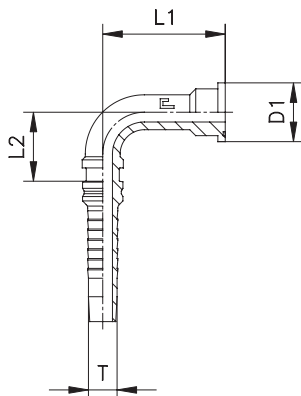

CODE	I.D. hose T			Ø flange	D1	L1	L2	PN [bar]
	DN	size	INCH					
807901	19	-12	3/4	3/4	38	52	52	350
807902	19	-12	3/4	1	44,5	55	52	350
807903	25	-16	1	1	44,5	61	68	320
807904	25	-16	1	1 1/4	50,8	63,5	68	280
807905	31	-20	1 1/4	1 1/4	50,8	74,5	81	280
807906	31	-20	1 1/4	1 1/2	60,3	80	81	210
807907	38	-24	1 1/2	1 1/2	60,3	90,5	105,5	210
807908	38	-24	1 1/2	2	71,4	96,5	105,5	210
807909	51	-32	2	2	71,4	112	142,5	210

Notes: If you wish to order a fitting in stainless steel, please change the first two digit from **80....** to **81....** .

SAE WHOLE 45° FLANGE 3000 PSI SERIES - SAE J518

Code: **8080.. INTERLOCK**
 Type: **SFL45**

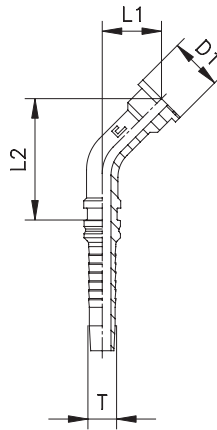

CODE	I.D. hose T			Ø flange	D1	L1	L2	PN [bar]
	DN	size	INCH					
808001	19	-12	3/4	3/4	38	25,5	82,5	350
808002	19	-12	3/4	1	44,5	27,5	84,5	350
808003	25	-16	1	1	44,5	28	103,5	320
808004	25	-16	1	1 1/4	50,8	30	105	280
808005	31	-20	1 1/4	1 1/4	60,3	33	123,5	280
808006	31	-20	1 1/4	1 1/2	60,3	36,5	127,5	210
808007	38	-24	1 1/2	1 1/2	60,3	40	157,5	210
808008	38	-24	1 1/2	2	71,4	44,5	161,5	210
808009	51	-32	2	2	71,4	46,5	205	210

Notes: If you wish to order a fitting in stainless steel, please change the first two digit from **80....** to **81....** .

SAE WHOLE STRAIGHT FLANGE 6000 PSI SERIES - SAE J518

Code: **8081.. INTERLOCK**
 Type: **SFS**

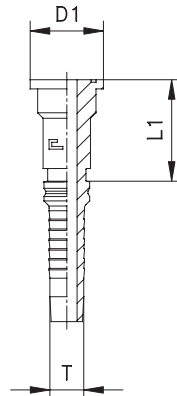

CODE	I.D. hose T			Ø flange	D1	L1	PN [bar]
	DN	size	INCH				
808101	19	-12	3/4	3/4	41,3	52	420
808102	19	-12	3/4	1	47,6	58	420
808103	25	-16	1	1	47,6	58,5	380
808104	25	-16	1	1 1/4	54	67	380
808105	31	-20	1 1/4	1 1/4	54	68,5	345
808106	31	-20	1 1/4	1 1/2	63,5	73,5	345
808107	38	-24	1 1/2	1 1/2	63,5	73,5	345
808108	51	-32	2	2	79,5	88	345

Notes: If you wish to order a fitting in stainless steel, please change the first two digit from **80....** to **81....** .

SAE WHOLE 90° FLANGE 6000 PSI SERIES - SAE J518

Code: **8082.. INTERLOCK**
 Type: **SFL90**

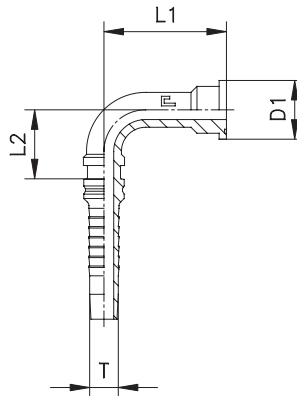

CODE	I.D. hose T			Ø flange	D1	L1	L2	PN [bar]
	DN	size	INCH					
808201	19	-12	3/4	3/4	41,3	56	52	420
808202	19	-12	3/4	1	47,6	62	52	420
808203	25	-16	1	1	47,6	68	68	380
808204	25	-16	1	1 1/4	54	75	68	380
808205	31	-20	1 1/4	1 1/4	54	86	81	345
808206	31	-20	1 1/4	1 1/2	63,5	94,5	81	345
808207	38	-24	1 1/2	1 1/2	63,5	105	105,5	345
808208	51	-32	2	2	79,4	136,5	142,5	345

Notes: If you wish to order a fitting in stainless steel, please change the first two digit from **80....** to **81....** .

SAE WHOLE 45° FLANGE 6000 PSI SERIES - SAE J518

Code: **8083.. INTERLOCK**
 Type: **SFL45**

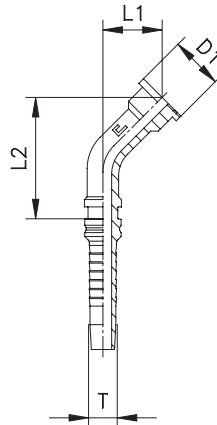

CODE	I.D. hose T			Ø flange	D1	L1	L2	PN [bar]
	DN	size	INCH					
808301	19	-12	3/4	3/4	41,3	28,5	85,5	420
808302	19	-12	3/4	1	47,6	32,5	89,5	420
808303	25	-16	1	1	47,6	33	108,5	380
808304	25	-16	1	1 1/4	54	38	113,5	380
808305	31	-20	1 1/4	1 1/4	54	41	131,5	345
808306	31	-20	1 1/4	1 1/2	63,5	47	137,5	345
808307	38	-24	1 1/2	1 1/2	63,5	50,5	167,5	345
808308	51	-32	2	2	79,4	64	222,5	345

Notes: If you wish to order a fitting in stainless steel, please change the first two digit from **80....** to **81....** .

STRAIGHT FAST CONNECTION WITH ELASTOMER SEAL

Thread BSP Parallel

Code: **8084...1**
Connection body

Code: **8084...2**
Insert

Code: **8084..**
Complete connection

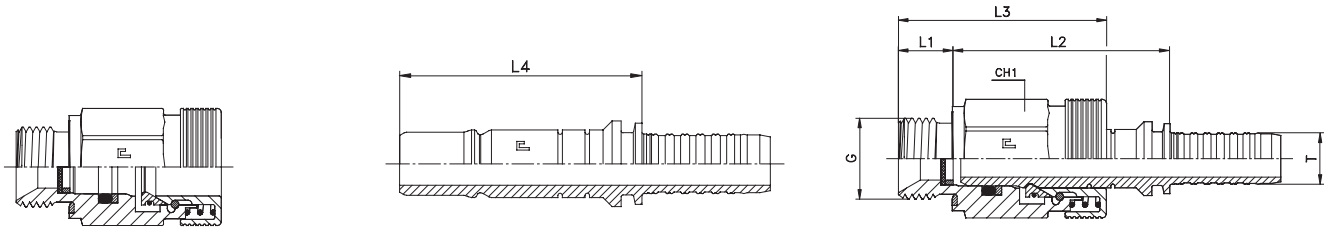

Ordering Body	Ordering Insert	Ordering Complete	T Ø int. Tube	G	L1	L2	L3	L4	CH1	PN [bar]
808402.1	808402.2	808402	DN6	1/4	12	53,5	53,5	47	22	350
808404.1	808404.2	808404	DN10	3/8	12	54,5	54	47,5	24	350
808405.1	808405.2	808405	DN12	1/2	14	55,5	53,5	53,5	27	350
808407.1	808407.2	808407	DN19	3/4	16	67,5	63	65,5	36	350
808408.1	808408.2	808408	DN25	1	18	88,5	81	80	41	250

Notes: If you wish to order a fitting in stainless steel, please change the first two digit from **80....** to **81....** .

FAST CONNECTION WITH ELASTOMER SEAL

Thread BSP Parallel

90° Elbow
Codice: **8085...2**
Insert

90° Elbow
Code: **8085..**
Complete

45° Elbow
Code: **8086...2**
Insert

45° Elbow
Code: **8086..**
Complete

Plug
Code: **8087...2**
Insert

Plug
Code: **8087..**
Complete

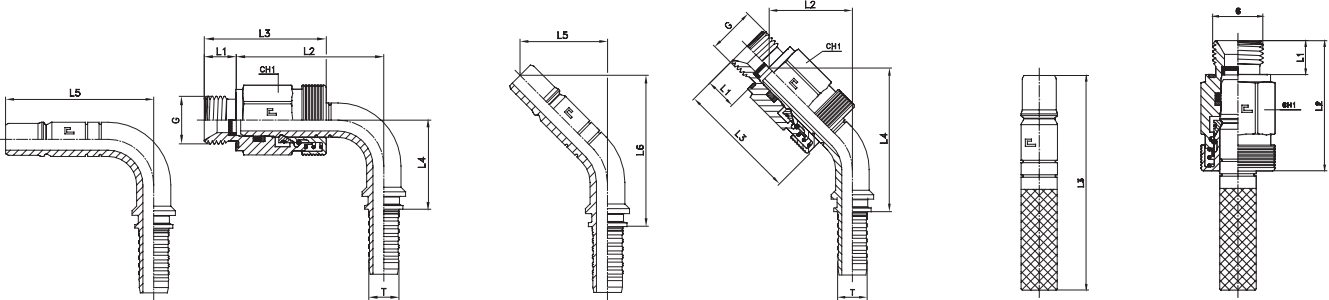

Ordering Body	Ordering Insert	Ordering Complete	T Ø int. Tube	G	L1	L2	L3	L4	L5	CH1	PN [bar]
808402.1	808502.2	808502	DN6	1/4	12	60	53,5	36,5	52	22	350
808404.1	808504.2	808504	DN10	3/8	12	69	54	40,5	62	24	350
808405.1	808505.2	808505	DN12	1/2	14	70,5	53,5	42,5	68,5	27	350
808407.1	808507.2	808507	DN19	3/4	16	94	63	49	92,5	36	350
808408.1	808508.2	808508	DN25	1	18	120,5	81	67	112	41	250

Notes: If you wish to order a fitting in stainless steel, please change the first two digit from **80....** to **81....** .

Ordering Body	Ordering Insert	Ordering Complete	T Ø int. Tube	G	L1	L2	L3	L4	L5	L6	CH1	PN [bar]
808402.1	808602.2	808602	DN6	1/4	12	38,5	53,5	76,5	33	71	22	350
808404.1	808604.2	808604	DN10	3/8	12	41,5	54	84,5	36,5	79,5	24	350
808405.1	808605.2	808605	DN12	1/2	14	42,5	53,5	86	41	84,5	27	350
808407.1	808607.2	808607	DN19	3/4	16	53	63	108,5	52	107,5	36	350
808408.1	808608.2	808608	DN25	1	18	73	81	147	67	141	41	250

Notes: If you wish to order a fitting in stainless steel, please change the first two digit from **80....** to **81....** .

Ordering Body	Ordering Insert	Ordering Complete	T Ø int. Tube	G	L1	L2	L3	CH1	PN [bar]
808402.1	808702.2	808702	DN6	1/4	12	53,5	120	22	350
808404.1	808704.2	808704	DN10	3/8	12	54	120	24	350
808405.1	808705.2	808705	DN12	1/2	14	53,5	145	27	350
808407.1	808707.2	808707	DN19	3/4	16	63	155	36	350
808408.1	808708.2	808708	DN25	1	18	81	170	41	250

Notes: If you wish to order a fitting in stainless steel, please change the first two digit from **80....** to **81....** .

HOSES BORE COLLAPSE CONTROL GAUGE

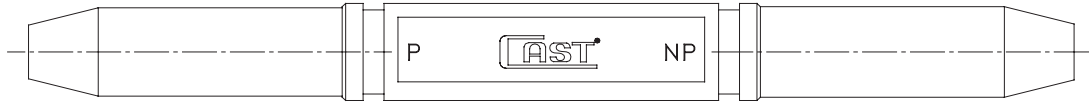

ORDERING COMPLETE GAUGE SET	DESCRIPTION	HOSES BORE COLLAPSE CONTROL GAUGE LIST	
		CODE	DESCRIPTION
STT-80	BRAIDED HOSES BORE COLLAPSE CONTROL GAUGE Ø3/16 - Ø2"	AS05STT-80	Braided Hoses Control Gauge 3/16
		AS06STT-80	Braided Hoses Control Gauge 1/4
		AS08STT-80	Braided Hoses Control Gauge 5/16
		AS10STT-80	Braided Hoses Control Gauge 3/8
		AS12STT-80	Braided Hoses Control Gauge 1/2
		AS16STT-80	Braided Hoses Control Gauge 5/8
		AS19STT-80	Braided Hoses Control Gauge 3/4
		AS25STT-80	Braided Hoses Control Gauge 1"
		AS31STT-80	Braided Hoses Control Gauge 1 1/4
		AS38STT-80	Braided Hoses Control Gauge 1 1/2
		AS51STT-80	Braided Hoses Control Gauge 2"
STS-80	SPIRAL HOSES BORE COLLAPSE CONTROL GAUGE Ø1/4 - Ø2"	AS06STS-80	Spiral Hoses Control Gauge 1/4
		AS10STS-80	Spiral Hoses Control Gauge 3/8
		AS12STS-80	Spiral Hoses Control Gauge 1/2
		AS16STS-80	Spiral Hoses Control Gauge 5/8
		AS19STS-80	Spiral Hoses Control Gauge 3/4
		AS25STS-80	Spiral Hoses Control Gauge 1"
		AS31STS-80	Spiral Hoses Control Gauge 1 1/4
		AS38STS-80	Spiral Hoses Control Gauge 1 1/2
AS51STS-80	Spiral Hoses Control Gauge 2"		
STM-80	THERMOPLASTIC HOSES BORE COLLAPSE CONTROL GAUGE Ø3/16 - Ø1"	AS05STM-80	Thermoplastic Hoses Control Gauge 3/16
		AS06STM-80	Thermoplastic Hoses Control Gauge 1/4
		AS08STM-80	Thermoplastic Hoses Control Gauge 5/16
		AS10STM-80	Thermoplastic Hoses Control Gauge 3/8
		AS12STM-80	Thermoplastic Hoses Control Gauge 1/2
		AS16STM-80	Thermoplastic Hoses Control Gauge 5/8
		AS19STM-80	Thermoplastic Hoses Control Gauge 3/4
		AS25STM-80	Thermoplastic Hoses Control Gauge 1"
STSI	INTERLOCK SPIRAL HOSES BORE COLLAPSE CONTROL GAUGE Ø3/4 - Ø2"	AS19STSI	Interlock Spiral Hoses Control Gauge 3/4
		AS25STSI	Interlock Spiral Hoses Control Gauge 1
		AS31STSI	Interlock Spiral Hoses Control Gauge 1 1/4
		AS38STSI	Interlock Spiral Hoses Control Gauge 1 1/2
		AS51STSI	Interlock Spiral Hoses Control Gauge 2"

O-RING

Code: 0301.. NBR

Code: 0302.. VITON®

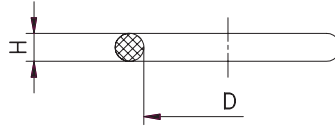

DIN 24° CONE

Code		D	H	ØTube
NBR	VITON®			
030102	030202	4	1,5	6L/S
030104	030204	6	1,5	8L/S
030105	030205	7,5	1,5	10L/S
030110	030210	9	1,5	12L/S
030113	030213	10	2	14S
030119	030219	12	2	15L/16S
030124	030224	15	2	18L
030127	030227	16,3	2,4	20S
030134	030234	20	2	22L
030135	030235	20,3	2,4	25S
030141	030241	25,3	2,4	30S
030142	030242	26	2	28L
030148	030248	32	2,5	35L
030149	030249	33,3	2,4	38S
030154	030254	38	2,5	42L

"B4" RING

Code		D	H	ØTube
NBR	VITON®			
030103	030203	6	1	6L/S
030107	030207	8	1	8L/S
030112	030212	10	1	10L/S
030118	030218	12	1	12L/S
030122	030222	14	1	14S
030123	030223	15	1	15L
030126	030226	16	1	16S
030130	030230	18	1	18L
030133	030233	20	1	20S
030136	030236	22	1	22L
030140	030240	25	1	25S
030143	030243	28	1	28L
030147	030247	30	1	30S
030150	030250	35	1	35L
030153	030253	38	1	38S
030156	030256	42	1	42L

FRONT SEAL SERIE 3000/6000 PSI

Code		D	H	ØTube
NBR	VITON®			
030181	030281	18,64	3,53	1/2
030182	030282	24,99	3,53	3/4
030183	030283	32,92	3,53	1
030184	030284	37,69	3,53	1 1/4
030185	030285	47,22	3,53	1 1/2
030186	030286	56,74	3,53	2

GAUGE SEAL

Code		D	H	Thread
NBR	VITON®			
030103	030203	6	1	G 1/4
030118	030218	12	1	G 1/2

BS5200 60° BSP CONE

Code		D	H	Nut
NBR	VITON®			
030101	030201	4	1	G 1/8
030103	030203	6	1	G 1/4
030107	030207	8	1	G 3/8
030118	030218	12	1	G 1/2
030126	030226	16	1	G 5/8
030130	030230	18	1	G 3/4
030136	030236	22	1	G 1
030147	030247	30	1	G 1 1/4
030150	030250	35	1	G 1 1/2
030168	030268	48	1	G 2

BS5200 60° CONE

Code		D	H	Nut
NBR	VITON®			
030101	030201	4	1	M12x1,5
030103	030203	6	1	M14x1,5
030107	030207	8	1	M16x1,5
030112	030212	10	1	M18x1,5
030118	030218	12	1	M20x1,5
030122	030222	14	1	M22x1,5
030130	030230	18	1	M26x1,5
030136	030236	22	1	M30x1,5
030143	030243	28	1	M38x1,5
030180	030280	32	1	M45x1,5

FRONT ORFS SEAL

Code		D	H	ØTube
NBR	VITON®			
030170	030270	7,65	1,78	6
030171	030271	9,25	1,78	8-10
030172	030272	12,42	1,78	12
030173	030273	15,6	1,78	14-15-16
030174	030274	18,77	1,78	18-20
030175	030275	23,52	1,78	22-25
030176	030276	29,87	1,78	28-30-32
030177	030277	37,82	1,78	35-38

THREAD BSP PARALLEL

Code		D	H	Thread
NBR	VITON®			
030106	030206	7,97	1,88	G 1/8
030115	030215	10,77	2,62	G 1/4
030121	030221	13,94	2,62	G 3/8
030129	030229	17,86	2,62	G 1/2
030137	030237	23,47	2,62	G 3/4
030146	030246	29,74	3,53	G 1
030152	030252	37,69	3,53	G 1 1/4
030158	030258	44,04	3,53	G 1 1/2
030160	030260	55,56	3,53	G 2

THREAD METRIC PARALLEL

Code		D	H	Thread
NBR	VITON®			
030108	030208	8,1	1,6	M10x1
030111	030211	9,3	2,2	M12x1,5
030116	030216	11,3	2,2	M14x1,5
030120	030220	13,3	2,2	M16x1,5
030125	030225	15,3	2,2	M18x1,5
030169	030269	17,3	2,2	M20x1,5
030132	030232	19,3	2,2	M22x1,5
030139	030239	23,6	2,9	M27x2
030144	030244	29,6	2,9	M33x2
030155	030255	38,6	2,9	M42x2
030159	030259	44,6	2,9	M48x2

THREAD UNF/UN-2A

Code		D	H	ØTube
NBR	VITON®			
030109	030209	8,92	1,83	7/16-20
030114	030214	10,52	1,83	1/2-20
030117	030217	11,9	1,98	9/16-18
030128	030228	16,36	2,2	3/4-16
030131	030231	19,18	2,46	7/8-14
030138	030238	23,47	2,95	1 1/16-12
030145	030245	29,74	2,95	1 5/16-12
030151	030251	37,46	3	1 5/8-12
030157	030257	43,69	3	1 7/8-12

RETAINING VALVES INTERIOR

Code		D	H	TIPO	APPLICATION
NBR	VITON®				
030161	030261	60	2,62	Body	Pipe Ø DIN 35L, 42L, 30S, 38S Pipe Ø JIC 37° 30, 32, 38 Thread BSP female 1 1/4, Gas 1 1/2, NPT 1 1/4, NPT 1 1/2, M42x2, M48x2

Notes: VITON® is a DuPont Dow Elastomers Trade Mark

ELASTOMER SEAL FOR ALL SERIES - Thread BSP Parallel - Metric parallel thread

Code: 0303.. NBR

Code: 0304.. VITON®

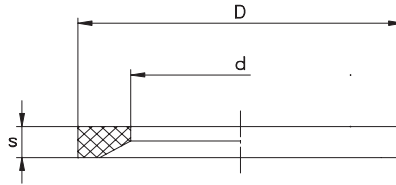

Ordering NBR	Ordering VITON®	Thread metrico	Thread gas	D	d	s
030301	030401	8x1		9,9	6,5	1
030302	030402	10x1	1/8	11,9	8,4	1
030303	030403	12x1,5		14,4	9,8	1,5
030304	030404	14x1,5	1/4	16,5	11,6	1,5
030305	030405	16x1,5		18,9	13,8	1,5
030306	030406		3/8	18,9	14,7	1,5
030307	030407	18x1,5		20,9	15,7	1,5
030308	030408	20x1,5		22,9	17,8	1,5
030309	030409		1/2	23,9	18,5	1,5
030310	030410	22x1,5		24,3	19,6	1,5
030311	030411	26x1,5 - 27x2	3/4	29,2	23,9	1,5
030312	030412	33x2	1	35,7	29,7	2
030313	030413	42x2	1 1/4	45,8	38,8	2
030314	030414	48x2	1 1/2	50,7	44,7	2

“B4” ELASTOMER SEAL

Code: 0305.. NBR

Code: 0306.. VITON®

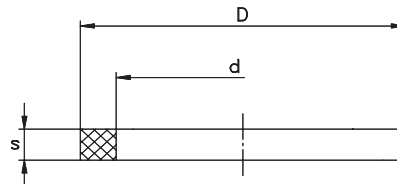

Ordering NBR	Ordering VITON®	Ø Tube	D	d	s
030501	030601	6L	9	7,3	3,5
030502	030602	6S	11	7,3	3,5
030503	030603	8L	11	9,3	3,5
030504	030604	8S	13	9,3	3,5
030505	030605	10L	12	10,5	4
030506	030606	10S	14	10,5	4
030507	030607	12L	13,7	12	4
030508	030608	12S	16	12	4
030509	030609	14S	18,5	15	3
030510	030610	15L	17,5	15	3
030511	030611	16S	19,5	16	3,5
030512	030612	18L	21,5	18	3,5
030513	030613	20S	25	20,6	3,5
030514	030614	22L	25	22	3,5
030515	030615	25S	30,5	25,1	4
030516	030616	28L	30,5	27,5	4
030517	030617	30S	36,5	30,2	3,5
030518	030618	35L	39,5	35,2	4
030519	030619	38S	46,5	38,2	3,5
030520	030620	42L	46,5	42,2	3,5

Notes: VITON® is a DuPont Dow Elastomers Trade Mark

O-RING CONTAINMENT SEAL

For stud ends with o-ring and washer
Thread BSP Parallel - Metric parallel thread

Type: **0023..**

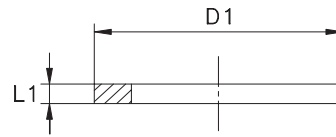

Ordering	Thread	D1	L1	Applications
002363	G 1/8	15	1,3	Stud end with o-ring
002364	G 1/4	19,5	1,8	Stud end with o-ring
002365	G 3/8	23,5	1,8	Stud end with o-ring
002366	G 1/2	28,5	1,8	Stud end with o-ring
002367	G 3/4	34,5	1,8	Stud end with o-ring
002368	G 1	43,5	2,6	Stud end with o-ring
002369	G 1 1/4	52,5	2,6	Stud end with o-ring
002370	G 1 1/2	60	2,6	Stud end with o-ring
002372	M 10x1	14,5	1	Stud end with o-ring
002373	M 12x1,5	17,5	1,4	Stud end with o-ring
002374	M 14x1,5	19,5	1,4	Stud end with o-ring
002375	M 16x1,5	22	1,4	Stud end with o-ring
002376	M 18x1,5	24	1,4	Stud end with o-ring
002378	M 22x1,5	28	1,4	Stud end with o-ring
002380	M 27x2	34	2	Stud end with o-ring
002381	M 33x2	41,5	2	Stud end with o-ring
002382	M 42x2	50,5	2	Stud end with o-ring
002383	M 48x2	56	2	Stud end with o-ring

COPPER WASHER

Thread BSP Parallel

Type: **0220..**

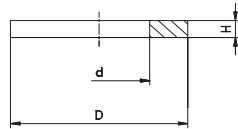

Ordering	Thread	d	D	H
022001	G 1/8	10	16	1,5
022002	G 1/4	13,5	19	1,5
022003	G 3/8	17	22	1,5
022004	G 1/2	21,5	27	1,5
022005	G 5/8	23	30	1,5
022006	G 3/4	27	33	1,5
022007	G 1	33,5	40	1,5
022008	G 1 1/4	42	50	1,5
022009	G 1 1/2	48	55	1,5
022010	G 2	60	68	1,5

COPPER WASHER

Metric parallel thread

Type: **0221..**

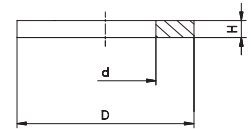

Ordering	Thread	d	D	H
022001*	M10x1	10	16	1,5
022102	M12x1,5	12	18	1,5
022103	M14x1,5	14	20	1,5
022104	M16x1,5	16	22	1,5
022105	M18x1,5	18	24	1,5
022106	M20x1,5	20	26	1,5
022107	M22x1,5	22	28	1,5
022108	M26x1,5	26	32	1,5
022109	M30x1,5	30	36	1,5
022110	M38x1,5	38	44	1,5
022111	M45x1,5	45	52	1,5

Notes: *Order with BSP thread code.

BONDED WASHER

Thread BSP Parallel

Type: **0320..**

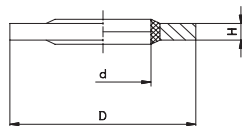

Ordering	Thread	d	D	H
032001	G 1/8	10,4	16	2
032002	G 1/4	13,7	20,5	2
032003	G 3/8	17,3	24	2
032004	G 1/2	21,5	28,5	2,5
032005	G 5/8	23,5	31,5	2,5
032006	G 3/4	27	35	2,5
032007	G 1	33,9	43	2,5
032008	G 1 1/4	42,9	52,5	2,5
032009	G 1 1/2	48,4	58,5	2,5
032010	G 2	60,5	73	2,5

BONDED WASHER

Metric parallel thread

Type: **0321..**

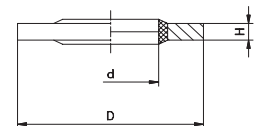

Ordering	Thread	d	D	H
032001*	M10x1	10,4	16	2
032002*	M12x1,5	13,7	20,5	2
032103	M14x1,5	14,9	22	2
032104	M16x1,5	16,5	25,5	2
032105	M18x1,5	19,7	27	2,5
032004*	M20x1,5	21,5	28,5	2,5
032005*	M22x1,5	23,5	31,5	2,5
032006*	M26x1,5	27	35	2,5
032109	M30x1,5	30,8	38	2,5
032110	M38x1,5	38,9	47,5	2,5
032009*	M45x1,5	48,4	58,5	2,5

Notes: *Order with BSP thread code.

FLUIDS COMPATIBILITY DATASHEET

The following table summarizes the best possible choices among the material of the fittings (carbon or stainless steel), the material of the seals (NBR or Viton®) and the hoses, related to the different compatibilities with the used fluid.

The data displayed are merely indicative as they can be affected by the actual system conditions (working pressure, temperature, etc.)

FLUIDS	CARBON STEEL	STAINLESS STEEL	RUBBER SEAL		Hoses		
			NBR	VITON®	BRAIDED	WIRED	TERMOPLASTIC
Ethyl acetate	C	A	D	D	D	D	E
Acetylene	C	B	A	A	D	D	A
Vinegar	C	A	A	A	D	D	E
Acetone	A	A	D	D	D	D	B
5% acetic acid	D	A	A	A	D	D	A
Boric acid	D	A	A	A	A	A	A
Carbonic acid	D	C	A	A	C	C	E
Citric acid	D	C	A	A	B	B	B
Hydrochloric acid	D	D	D	A	D	D	E
Hydrofluoric acid	D	D	C	C	D	D	E
Formic acid	D	D	D	D	D	D	E
Phosphoric acid	D	C	D	A	D	D	C
Lactic acid	D	A	A	A	D	D	E
Nitric acid	D	C	D	A	D	D	D
Sulfuric acid	C	C	D	A	C	C	D
Tannic acid	D	D	A	A	A	B	C
Water	C	A	A	A	A	A	A
Water-glycol	A	A	A	A	A	A	A
Deionized water	C	A	A	A	A	A	A
Distilled water	C	A	A	A	A	A	A
Seawater	D	C	A	A	C	C	E
Hydrogen peroxide	D	A	B	A	E	E	E
White spirit	A	A	B	A	C	C	C
Turpentine	C	A	B	A	C	C	C
Sewage	C	C	A	A	C	C	C
Addinol Okoplus HETG 32-68	A	A	E	E	B	B	E
Addinol Okosynth HEES 46	A	A	E	E	C	C	E
RTV silicone adhesives and glues	A	A	E	E	D	D	E
AeroShell Fluid 41	E	E	E	E	A	A	A
AeroShell Turbine Oil 500	A	A	A	A	C	C	E
Agip Arnica Extra Plus	E	E	E	E	B	B	B
Agip Arnica Plus	E	E	E	E	A	A	A
Agip Arnica 22, 32, 46, 68	A	A	B	B	B	B	A
Agip ATF IID	E	E	E	E	D	B	D
Agip Oso 32	E	E	E	E	A	A	A
Agip Sint 2000	E	E	E	E	A	B	A
Amyl alcohol	D	A	A	A	D	D	E
Butyl alcohol (butanol)	C	A	A	A	C	C	E
Ethyl Alcohol (Ethanol)	C	A	A	C	B	B	B
Isopropyl alcohol	C	A	C	A	C	C	E
Methyl alcohol (Methanol)	C	A	B	D	C	C	B
Ammonia gas (cold)	A	A	A	D	A	B	A
Liquid ammonia	C	A	A	D	B	B	A
Anderol 497	E	E	E	E	B	C	B
Carbon dioxide	A	A	A	A	C	C	B
Aniline	A	A	D	C	D	D	C
Aral Vitam DE 46, 68	A	A	A	A	A	A	B
Aral Vitam GF 68	E	E	E	E	A	A	A
Argon	D	A	A	A	E	E	E
Air	A	A	A	A	A	A	A
Dry air	A	A	A	A	B	B	A
Compressed air	A	A	A	A	A	A	A
Aromatic 100.150	A	A	E	E	C	C	E
Asphalt	D	A	A	A	C	C	E
Avia Sintofluid N32	A	A	E	E	A	B	A
Avia Sintofluid N46	A	A	E	E	A	A	A
Nitrogen	A	A	A	A	B	B	B
Benzene, Benzol	A	A	D	A	D	D	C
Petrol	A	A	A	A	D	D	B
Gasoline (isooctane)	A	A	A	A	A	B	A
Gasoline (70% iso-octane, 30% toluene)	A	A	D	C	B	C	A
Gasoline (50% iso-octane, 50% toluene)	A	A	D	C	C	D	B
Unleaded	A	A	A	A	D	D	E

Notes: VITON® is a DuPont Dow Elastomers Trade Mark

FLUIDS COMPATIBILITY DATASHEET

FLUIDS	CARBON STEEL	STAINLESS STEEL	RUBBER SEAL		Hoses		
			NBR	VITON®	BRAIDED	WIRED	TERMOPLASTIC
Baking soda	A	B	A	A	A	A	A
BINOL Hyd	E	E	E	E	B	A	B
Sulfur dioxide	D	A	D	A	D	D	D
Sodium bisulphate	C	C	A	A	D	D	E
Carbon disulfide	A	A	D	A	E	E	E
Borax	C	A	A	A	C	C	E
BP Energol HLP-HM 68	A	A	E	E	A	A	E
BP Biohyd 46	A	A	B	B	B	B	A
BP Vanellus C5	E	E	E	E	B	C	C
Frost	D	C	E	E	C	C	E
Butane	A	A	A	A	C	C	A
Castrol 5000	A	A	E	E	C	C	E
Castrol Aero HF 585	A	A	A	A	A	B	A
Castrol Brayco 717	B	B	B	B	B	B	B
Castrol Brayco Micronic 882	A	A	E	E	A	B	E
Castrol Brayco Micronic 889	A	A	E	E	C	C	E
Castrol Bio Tec Alpin 22	A	A	E	E	A	A	A
Castrol Hyspin HDH 7000	E	E	E	E	A	A	A
Castrol Icematic SW 100	E	E	E	E	B	B	C
Castrol Aerial Lift Fluid	E	E	E	E	A	A	A
Tar	D	A	A	A	D	D	E
Cellugard	A	A	A	A	A	A	E
Kerosene	A	A	A	A	A	B	E
Chevron Clarity Hydraulic Oil AW 32, 46, 68	A	A	E	E	A	A	E
Chevron FLO-COOL 180	A	A	E	E	C	C	E
Chevron HyJet IV	A	A	E	E	D	D	E
Chevron Hidraulic MV Oil AW 15, 32, 46, 68, 100	A	A	E	E	A	A	E
Potassium chlorate	D	C	E	E	A	A	A
Chlorine	D	A	D	A	C	C	C
Ammonium chloride	D	D	A	E	A	A	E
Calcium chloride	C	D	A	A	A	A	A
Ethyl chloride	C	C	A	A	D	D	E
Magnesium chloride	D	D	A	A	A	A	E
Methyl chloride	A	A	D	A	D	D	E
Copper chloride	D	D	A	A	A	B	E
Sodium chloride	D	A	A	A	B	B	B
Zinc chloride	D	C	A	A	A	A	A
Sulfur chloride	C	C	D	A	D	D	E
Glue	A	A	E	E	C	C	C
Coolanol 20, 25R, 35R, 45R, OS-59	A	A	A	A	A	A	A
DEA Econa E46	A	A	A	E	B	C	A
Goddess Triton SE 55	E	E	E	E	B	B	B
Diester	A	A	B	A	D	D	E
Sulfur dioxide	D	C	D	D	D	D	D
Dot 3	E	E	E	E	D	B	D
Dot 4	E	E	E	E	D	B	D
Dow Corning 200, 510, 550, C6-560	A	A	E	E	A	A	E
Dow HD50-4	C	A	E	E	C	C	E
Dowtherm A, E	A	A	D	A	D	D	E
DOWTHERM G	A	A	E	E	D	D	E
Elf Hydrelf Bio 46	A	A	E	E	A	A	E
Helium gas	A	A	A	A	D	D	E
Emkarate RL 100S	E	E	E	E	C	B	C
Hexane	A	A	C	A	C	C	E
Esso Dexron III ATF	A	A	E	E	B	B	A
Esso Esstic 42,43	A	A	A	A	A	A	A
Esso Nuto H46, H68	A	A	E	E	A	A	E
Esso Hydraulicoil HE 46	A	A	E	E	B	B	A
Esso Teresstic	A	A	E	E	A	A	E
Esso Turbo Oil 2380	A	A	E	E	A	B	E
Esso Univis J26	A	A	E	E	A	A	E
Esso Univolt 60, N 61B	A	A	E	E	A	B	E
Polyol ester	A	A	E	E	D	D	E
Mixed phosphate ester	A	A	E	E	D	D	E
Phosphoric esters	A	A	E	E	D	D	E
Foreign silicates	A	A	A	A	B	B	E
Ethane	A	A	A	A	C	C	E
Ether	A	A	E	E	E	E	E
Petroleum ether	A	A	E	E	C	C	E
Ethylcellulose	D	C	E	E	C	C	E
Ethylene diclorato	D	D	E	E	D	D	E

Notes: VITON® is a DuPont Dow Elastomers Trade Mark

FLUIDS COMPATIBILITY DATASHEET

FLUIDS	CARBON STEEL	STAINLESS STEEL	RUBBER SEAL		Hoses		
			NBR	VITON®	BRAIDED	WIRED	TERMOPLASTIC
Phenol (carbolic acid)	D	A	D	A	D	D	E
Fina Biohydran AW 46	E	E	E	E	B	B	B
Finke Aviaticon HE HY-46	A	A	E	E	A	A	E
Formaldehyde	D	A	C	D	D	D	E
Ammonium phosphate	D	C	A	E	A	A	E
Fragol Hydraulic HE 46	A	A	E	E	C	C	E
Fragol Hydraulic TR 46	A	A	E	E	B	B	E
Freon 12	A	A	A	A	D	D	E
Freon 22 A D D E A	A	A	D	D	D	D	E
Freon 113, 114	A	A	A	A	D	D	E
Freon 502	A	A	A	A	D	D	E
Fuchs Planto Hytrac	E	E	E	E	A	A	B
Fuchs PlantoHyd S46	E	E	E	E	A	A	E
Fuchs Plantosyn 3268	A	A	E	E	A	A	E
Fuchs Plantosyn 3268 Eco	A	A	E	E	C	C	E
Fuchs Renolin MR 320, 520	E	E	E	E	B	A	A
Fyre-Safe 120C, 126,155,1090 And, 1150,1120,1300 E	A	A	E	E	D	D	E
Fyre-Safe 200C, 211, 225	A	A	E	E	A	B	E
Fyre-Safe W / O	A	A	E	E	A	A	E
Fyrguard 150, 150-M, 200	A	A	E	E	A	A	E
Fyrquel 60, 90,100,150,220,300,500,550,1000	A	A	E	E	D	D	E
Fyrquel EHC, GT, LT, VPF	A	A	E	E	D	D	E
Fyrtek MF, 215, 290, 295	A	A	E	E	D	D	E
Fuel Gas	D	A	A	C	E	E	E
Liquefied petroleum gas (LPG)	A	A	A	A	C	C	E
Natural gas	A	A	A	A	B	B	E
Natural gas untreated	A	A	A	A	B	B	E
Diesel fuel	A	A	A	A	B	B	A
Glycerine	A	A	A	A	A	A	A
Glycol	A	A	A	A	A	A	A
Ethylene glycol	A	A	A	A	A	B	E
Fat	A	A	A	A	A	A	E
Animal fat	C	A	A	A	C	C	E
Gulf FR Fluid P37, P40, P43, P47	A	A	A	A	D	D	E
H-515 (NATO)	A	A	E	E	A	A	E
Houghton Safe 271 to 640	A	A	A	A	A	B	B
Houghton Safe 419R	A	A	E	E	A	A	E
Houghton Safe 1010,1055,1110,1115,1120,1130	A	A	D	A	D	D	E
Safe Houghto 5046, 5046W, 5047F	A	A	A	A	A	A	E
Houghton Cosmolubric HF-122, HF-130, HF-144	A	A	E	E	C	D	C
Hydrolubric 120B, 141	A	A	E	E	A	B	E
Hydro Safe Water Glycol 200	A	A	E	E	A	A	E
Hydrogen	A	A	A	A	D	D	E
Ammonium hydroxide	C	A	D	D	C	C	C
Calcium hydroxide	A	A	A	A	A	A	A
Magnesium hydroxide	C	C	A	A	B	B	B
Potassium hydroxide	C	A	A	D	B	B	B
Sodium hydroxide	A	A	A	A	C	B	C
Hydride ammonia	D	D	E	E	D	D	E
Iodine	D	A	C	A	E	E	E
Calcium Hypochlorite	D	D	A	A	D	D	E
Sodium hypochlorite	D	D	A	A	C	C	C
Isocyanate	A	A	E	E	C	C	E
Isopar H	A	A	E	E	D	D	E
Isooctane	A	A	A	A	C	C	E
JP3, JP4, JP5	A	A	C	C	B	B	B
Kaeser 150P, 175P, 325R, 687R	A	A	E	E	D	D	E
Lindol HF	A	A	D	A	D	D	E
Brake Fluid	D	D	C	D	D	D	E
Mercaptan	E	E	D	A	D	D	E
Mercury	E	E	A	A	A	A	A
Methane	A	A	A	A	A	B	E
Methyl ethyl ketone	C	A	D	D	D	D	D
Methylisopropylketone	C	A	D	D	D	D	E
Metlube 220	E	E	E	E	C	B	C
MIL-B-46 176	D	D	E	E	D	D	E
MIL-H-46 170	A	A	E	E	C	C	E
MIL-H-5606	A	A	A	A	A	B	B
MIL-H-6083	A	A	A	A	A	B	E
MIL-H-7083	A	A	A	B	A	B	C
MIL-H-83 282	A	A	E	E	A	B	E

Notes: VITON® is a DuPont Dow Elastomers Trade Mark

FLUIDS COMPATIBILITY DATASHEET

FLUIDS	CARBON STEEL	STAINLESS STEEL	RUBBER SEAL		Hoses		
			NBR	VITON®	BRAIDED	WIRED	TERMOPLASTIC
MIL-L-2104, 2104B	A	A	A	A	A	B	E
MIL-L-23 699	A	A	E	E	C	C	E
MIL-L-7808	B	A	B	A	A	B	C
Mobil Aero HFA	A	A	E	E	A	B	E
Mobil Aero HFE	A	A	E	E	A	B	B
Mobil ATF Fluid	E	E	E	E	C	A	B
Mobil Delvac 1300 (series)	E	E	A	A	A	B	A
Mobil DTE 11M, 13M, 15M, 16M, 18M, 19M	A	A	E	E	A	B	E
Mobil DTE 22, 24, 25, 26	A	A	A	A	A	B	C
Mobil EAL Arctic 22	E	E	E	E	B	A	B
Mobil EAL 224H	A	A	E	E	A	B	A
Mobil Glygoyle 11, 22, 30	A	A	E	E	A	A	A
Mobil Hydrofluid HFDU 68	E	E	E	E	A	A	A
Mobil Jet II	A	A	E	E	C	C	E
Mobil NYVAC 20, 30, 200D, FR	A	A	E	E	A	B	E
Mobil Pyrogard 42, 43, 51, 53, 55	A	A	D	A	D	D	D
Mobil Pyrogard	A	A	E	E	A	B	E
Mobil Rarus 826, 827, 829	A	A	E	E	D	D	E
Mobil SHC 524	E	E	E	E	C	B	C
Mobil Therm 600	E	E	A	A	B	B	B
Mobil Vactra	A	A	E	E	A	A	E
Mobilfluid 423	A	A	E	E	A	B	E
Mobilgear SHC 150, 220, 320, 460, 600, 680, 800	A	A	E	E	C	C	E
Mobilarma 525	A	A	E	E	A	A	E
Molub-Alloy Tribol 890	A	A	E	E	D	D	E
Moly Lube 902 HF	A	A	E	E	C	C	E
Monolec 6120	A	A	E	E	A	A	E
Carbon monoxide	A	A	A	A	C	C	E
Morpholine	D	A	E	E	D	D	E
Naphtha	A	A	A	A	B	B	A
Naphthalene	A	A	D	A	D	D	A
Neon	D	A	A	A	E	E	E
Neste Biohydraul SE 46	E	E	E	E	A	A	A
Ammonium nitrate	C	A	A	E	A	A	B
Sodium nitrate	A	A	A	A	C	C	E
Nitrobenzene	D	C	D	A	D	D	E
Silicone oils	A	A	A	A	A	A	E
Oil-based oil	A	A	A	A	A	A	E
ASTM oil n ° 1, 5	A	A	A	A	A	A	A
ASTM oil n ° 2, 4	A	A	A	A	A	B	A
ASTM Oil No. 3	A	A	A	A	A	C	A
Heating oil	A	A	A	A	A	B	E
Cottonseed oil	A	A	A	A	A	B	E
Linseed oil	A	A	A	A	A	A	E
Petroleum oil	A	A	A	A	A	B	E
Castor oil	A	A	E	E	A	A	E
Soybean oil	A	A	A	A	A	B	E
Mineral oil	A	A	A	A	A	A	E
Mineral oil	A	A	C	A	A	A	E
Hydraulic oil	A	A	A	A	E	E	E
Oil for braking systems A	A	A	D	D	E	E	E
Transmission fluid (ATF)	A	A	A	A	A	A	E
Vegetable oil	A	A	A	A	E	E	E
OMV Biohyd MS 46	E	E	E	E	B	B	B
Carbon monoxide	A	A	A	A	B	B	E
Oxygen D D D E A	D	A	D	D	D	D	E
Ozone	A	A	D	A	C	C	E
Panolin Gro Synth 46	E	E	E	E	B	B	E
Panolin HLP Synth 46	A	A	E	E	A	B	E
Paraffin	E	E	C	A	A	A	A
Pentane	E	A	A	A	A	C	A
Pentane liquid	E	A	A	A	A	C	A
Pentosin CHF 11 S	E	E	E	E	C	B	C
Perchloroethylene	C	A	A	A	D	D	C
Hydrogen peroxide	D	B	D	D	D	D	E
Sodium peroxide	D	A	A	A	D	D	E
Polyalkylene glycol (PAG)	A	A	E	E	C	B	E
Propane	A	A	A	A	D	D	E
Propylene glycol	C	C	A	A	A	B	E
Pydraul 60, 150, 625, F9	A	A	D	A	D	D	E
Pydraul 135, 230C, 312F, 540C	A	A	D	A	D	D	D

Notes: VITON® is a DuPont Dow Elastomers Trade Mark

FLUIDS COMPATIBILITY DATASHEET

FLUIDS	CARBON STEEL	STAINLESS STEEL	RUBBER SEAL		Hoses		
			NBR	VITON®	BRAIDED	WIRED	TERMOPLASTIC
Pydraul A200	A	A	D	A	D	D	E
Q8 Handel 68	E	E	E	E	C	B	C
Quaker QUINTOLUBRIC 888	C	A	B	A	A	A	A
Quaker QUINTOLUBRIC 822 (series), 833	C	A	B	A	B	C	A
Quaker QUINTOLUBRIC 957, 958	C	A	B	A	A	B	A
Raisio Biosafe HO 46 SE	E	E	E	E	B	B	B
Refrigerant HFC134	A	A	E	E	D	D	E
Revolt S.B.H.	E	E	E	E	A	A	B
Safety Kleen Hydraulic ISO VG 32, 46, 68	A	A	E	E	A	B	E
Santoflex 13	A	A	E	E	C	C	E
Santosafe 300	A	A	E	E	D	D	E
Santosafe W-G 15, 20, 30	A	A	E	E	A	A	E
Shell Cassida HF 46	E	E	E	E	B	B	B
Shell Clavus 32, 68	A	A	E	E	D	D	E
Shell Comptella	A	A	E	E	C	C	E
Shell Comptella S46, S68, MS	A	A	E	E	C	C	E
Shell Corena D	E	E	E	E	C	B	C
Shell Diala A, AX	A	A	A	A	A	B	A
Shell Naturelle HFE 15, 32, 46, 68	A	A	A	A	B	B	A
Shell Pella	A	A	E	E	A	A	E
Rimula X	E	E	E	E	B	A	B
Shell Tellus	A	A	A	A	A	A	A
Shell Tellus Arctic 32	E	E	E	E	A	B	A
Shell Thermia	A	A	E	E	A	A	E
Shell Turbo	A	A	E	E	C	C	E
Shell V-Oil 1404	E	E	E	E	B	B	B
Sodium silicate	A	A	A	A	A	A	E
Silicone	A	A	A	A	E	E	E
Soda (Sodium Carbonate)	A	A	A	A	A	A	E
Ammonium sulfate	C	C	A	D	A	A	A
Magnesium sulfate	A	A	A	A	A	A	E
Copper sulphate	D	C	A	A	A	A	E
Sodium sulfate	A	A	A	A	A	A	A
Carbon disulphide	A	A	D	A	D	D	E
Hydrogen sulfide	D	C	E	E	D	D	E
Potassium sulphide	A	A	A	A	A	A	A
Zinc sulphide	D	A	E	E	A	A	A
Solutia's Skydrol 5, 500B-4, LD-4	A	A	D	B	D	D	A
Solutia's Skydrol 500	E	E	D	D	D	D	D
Solutions of soap	A	A	A	A	C	C	E
Stoddard solvent	A	A	A	A	C	C	E
Lacquer solvents	D	A	E	E	D	D	E
SSR Ultra Coolant	E	E	E	E	B	A	B
Styrene	E	A	D	A	E	E	E
Tamoil Green Hydro Safety 46	E	E	E	E	A	A	A
Teboil Hydraulic Eco 46	A	A	E	E	C	C	E
Teboil Hydraulic Oil Polar	E	E	E	E	A	B	A
Carbon tetrachloride	C	C	A	A	D	D	E
Texaco Hydra 46	E	E	E	E	A	B	A
Toluene, Toluene	A	A	D	C	D	D	B
Turpentine	A	A	A	A	D	D	E
Trichloroethylene	D	A	C	A	D	D	C
TrielinaC	D	C	D	C	E	E	E
Trim-Sol	A	A	E	E	A	B	E
Sulfur trioxide	D	D	D	A	D	D	E
Ucon Hydrolube J-4	A	A	B	C	B	C	B
Urea	C	C	A	A	C	C	E
Urethane	A	A	E	E	A	A	E
Steam	C	A	C	C	D	D	E
Varsol fluids	A	A	E	E	C	C	E
Paint	C	A	A	A	D	D	E
Enamel paint	D	A	C	C	D	D	E
Versilube F44, F50, F55	A	A	A	A	A	A	A
Xylene Xylene	A	A	D	A	D	D	A
York 777	E	E	E	E	B	B	B
Zerol 150	A	A	E	E	A	A	E
Sulfur	D	C	D	A	B	B	B

Caption: A = optimum B = good C= enough D= not recommended E= insufficient data

Notes: VITON® is a DuPont Dow Elastomers Trade Mark

AREE DI VENDITA • SALES AREAS



- Catalogo Tecnico Commerciale, testi originali in lingua italiana da cui sono state ricavate le traduzioni per i testi dei cataloghi esteri, in caso di dissonanza interpretativa, questo è l'originale che fa testo.
- I dati tecnici, le misure, etc. menzionate sul presente catalogo sono riportati in buona fede ed a titolo informativo. Riguardano tutte le serie, le formule, le tabelle riportate, compresi i tubi flessibili.
- In caso di modifiche, cambiamenti di modelli o abbandono di fabbricazione, non è possibile obbligarci a consegnare articoli con le caratteristiche precedenti, se sostituibili con altri di pari prestazione.
- Per le condizioni generali di fornitura, fanno testo gli accordi sottoscritti tra le parti a livello commerciale.
- La CAST si riserva il diritto di apportare senza preavviso tutte le modifiche di forma e dimensione suggerite dal progresso tecnologico, derivante dalla ricerca e sviluppo della nostra società.
- Il presente catalogo sostituisce ed annulla a tutti gli effetti i precedenti.
- Edizione: 1/C - Stampato: Ottobre 2013



- *This technical commercial catalogue was originally made in Italian and then translated. In case of misinterpretation or misunderstanding of the whole or of any of the parts here contained, it is the Italian language legally binding.*
- *The technical data, measurements etc. indicated in this catalogue are for guidance purposes only. Cover all series, formulas, tables, including the hoses.*
- *In case of modifications, change of model or phasing out, we cannot be obliged to deliver products with the previous characteristics, if replaced with others of equal performance.*
- *For the general terms of supply, agreements signed between the parties are binding.*
- *To keep updated with Technological developments, CAST S.p.A. reserves the right to modify shape and dimensions without prior notice, arising from research and development of our society.*
- *This catalogue replaces and supersedes at all effects the ones issued before.*
- *Issued: 1/C - Printed: October 2013*



Sede: Amministrativa, Commerciale, Legale.
STRADA BRANDIZZO, 404/408 bis - 10088 VOLPIANO (TO)
Tel.: +39.011.9827011 r.a. - Fax.: +39.011.98270225

Sede: Stabilimenti produttivi e di Montaggio.
Via Regione Gamna 3 - 12030 Casalgrasso (CN)
Tel.: +39.011.975816 - Fax.: +39.011.975718

www.cast.it - cast@cast.it



Corporate Headquarters

Eastern Region - World Wide Metric

37 Readington Road - Branchburg, NJ 08876 - Tel. 732.247.2300 - Fax 732.247.7258

Midwest Region

11853 Belden Court
Livonia, MI 48150
Tel: 734.206.4350
Fax: 734.293.4235

Gulf Region

2103 E. Governors Circle
Houston, TX 77092
Tel. 713.682.2400
Fax 713.682.2481

Western Region

16360 Downey Ave
Paramount, CA 90723
Tel. 562.633.4141
Fax 562.633.3280

Southeastern Region

3402 SW 26th Terrace Ste B-11
Ft. Lauderdale, FL 33312
Tel: 954.321.0784
Fax: 954.321.2591

www.worldwidemetric.com - sales@worldwidemetric.com